

*You enjoyed Terminator ... Predator ... Gladiator ?
You'll fall for*

ACCELERATOR

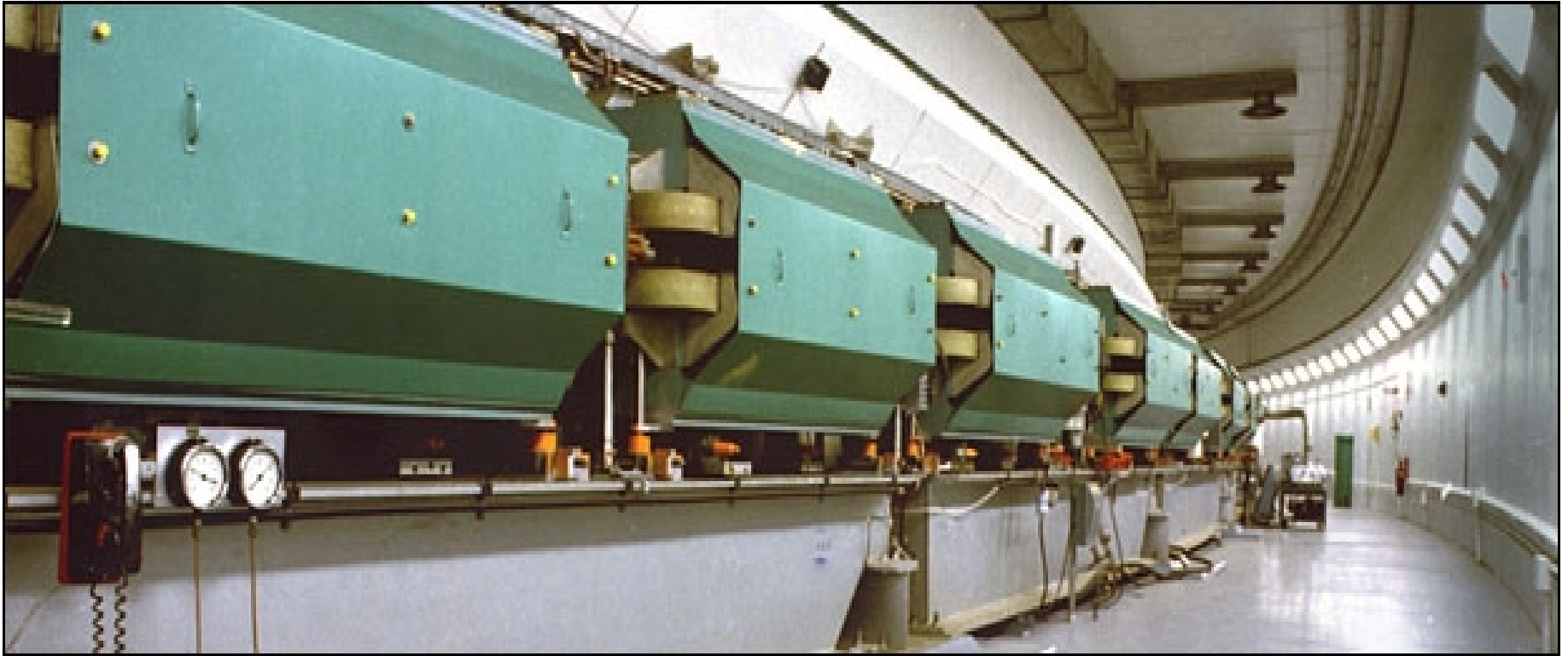

Bibliography

- A. Sessler, E. Wilson, Engines of Discovery, World Scientific (2007)
- M.S. Livingston, The Development of High-Energy Accelerators, Dover Pub. Inc., NY (1966).
- CERN Accelerator School archives
- JACoW <http://www.jacow.org/>
- Joint Universities Accelerator School lectures
<http://www.esi-archamps.eu/Thematic-Schools/Discover-JUAS>
- USPAS archives
- National Lab sites, US, EU
- CERN documentation web sites
- BNL's Flickr photo gallery
- Wikipedia
- G. Leleux, Circular accelerators, INSTN lectures, SATURNE Laboratory, CEA Saclay (Juin 1978).

- **Charged particle accelerators have thrived over a century, they are nowadays – we live terrific times ! engines of discovery in many areas of life, matter, energy science, they have accessed a forefront place in scientific research, industry and societal applications**
- **Depending what they are use at, they are known as “atom smasher”, “light source”, “spallation neutron source”, “neutrino factory”, “collider”, “hadrontherapy machine”, “optical klystron” and many others – as varied as their applications are varied**

This “tour of the accelerator planet”, casts a glance at the origin of these modern, ultra-high-tech instruments, at today's state-of-the-art, and in some cases at where they are heading for...

- **Major accelerator styles will be introduced, following the order they appeared, chronologically :**
 - **Electrostatic accelerators**
 - **Linear accelerator**
 - **Cyclotron family**
 - **Betatron**
 - **Synchrotron**

We'll keep the following in mind, as it gives an understanding of the evolutions, and of preferred technologies depending on the application :

Accelerators are “particle factories”

- **They have been invented, developed, for producing very energetic and/or intense beams of particles :**

elementary particles, ions of all sorts, radioactive or not, neutrons, cosmic type of particles, neutrinos, photons, etc.,

- **for a number of researches and applications :**

particle discovery, search for missing mass, cosmology, condensed matter, radio-biology, cancer treatment, X-lasers, oodles of industrial applications, weapons, etc

LIVINGSTON DIAGRAM

- Particle accelerators were born in the quest of “atom smashers”, in a context of needs for higher and higher energies, beyond natural radioactivity bodies, in the several MeV range :
for producing high energy e^- and ion beams, probing the atomic nucleus, creating new elements and isotopes

For reference : high energy alpha from radioactive particles were ~ 10 MeV.

- In the era of nuclear R&D, civil and military, they allow(ed) extensive production of data on radio-isotopes, production cross-sections...
- Very high energies have opened the field of accelerator based particle physics
- Energies have increased exponentially over the years, more or less saturating depending on the technology
- Later, with discoveries as synchrotron radiation, hadron-therapy, and given their potential for number of applications, accelerators found themselves predilection tools in many domains of science : production of X-rays, medical, industry...



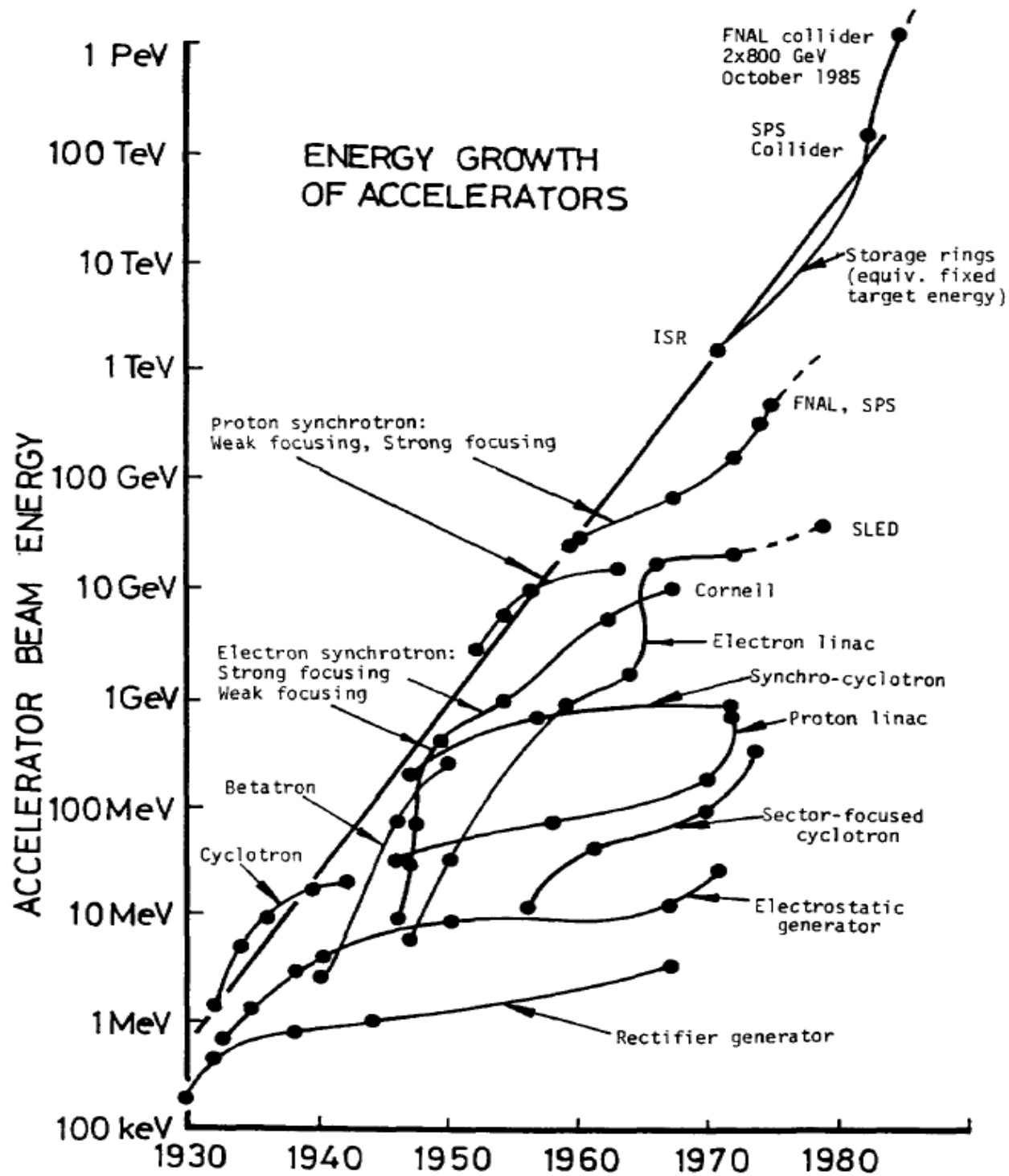

ELECTROSTATIC ACCELERATORS

The first particle accelerator

- Cathode rays, we know: the TV e-beam !
They were observed in vacuum glass tubes (*vacuum pump, a major component in accelerators, was invented in 1654*), created using two electrodes, kVolts typically, back at the end of 19th century, 1869.
- J. J. Thomson, *circa* 1897, showed that cathode rays are beams of unknown negatively charged particle.
He measured them to be 1800 times lighter than hydrogen atom.
He later named them “electron”.
- These works earned him the 1906 Nobel prize

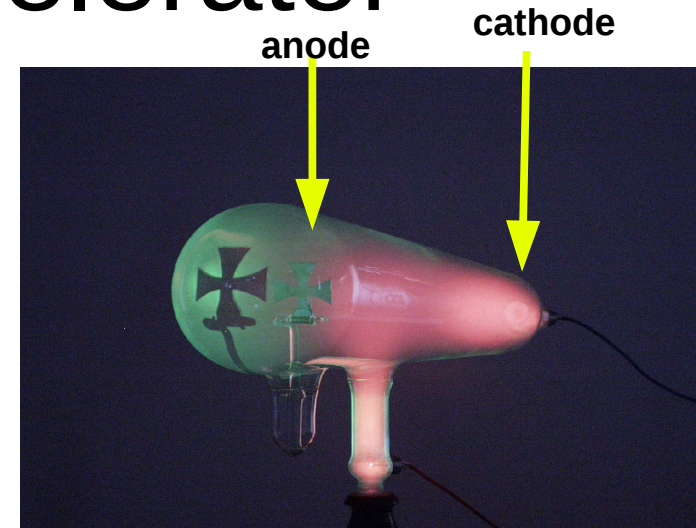

The shadow of the cross, on the glass to the left, reveals that cathode rays travel straight: a beam of elementary particles traveling to the anode, from the cathode at the right.

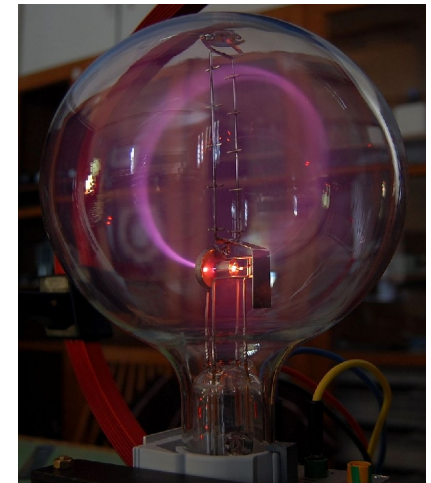

Gas fluorescence as cathode rays loop in the field of an Helmholtz coil.

- Creating strong electrostatic potential : simplest and most obvious method. This is a way to communicate energy to charged particles, by virtue of

$$\vec{F} = -q \text{grad}V, \quad W = qV$$

- There was a broad context of development of high voltage generators :
 - Wimshurst wheel (1880s - 10s kV, few tens μAmp), Marx generator (1924 - a variant of a voltage-multiplier), Tesla coil (induction high voltage) ...
 - Two methods succeeded : Crockcroft-Walton voltage multiplier, Van de Graaff electrostatic generator.
- Limitation on potential achievable for particle acceleration resides in
 - ohmic losses in apparatus structure - proportional to potential
 - current from ionized gas - limited by saturation
 - corona discharge - the major cause

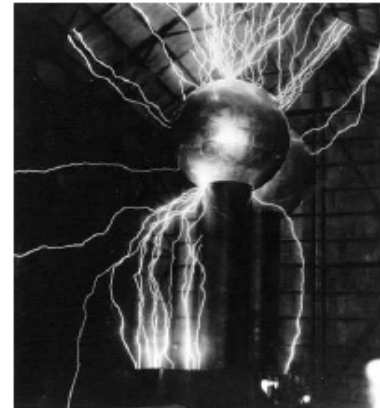

Cockcroft-Walton (1/3)

- A particular type of “voltage multiplier” (also known as “Greinacher multiplier”, earlier proposed by Heinrich Greinacher, Swiss, 1919), coupled to accelerating gaps, at Cavendish Lab., 1932 :
- interest of *accelerator method* proven by allowing first artificial nuclear transmutation, ${}^7_3\text{Li} + p \longrightarrow 2 \times \alpha + 17 \text{ MeV}$
- Only 20 years later, 1951, did they get the Nobel prize “for their pioneer work on the transmutation of atomic nuclei by artificially accelerated atomic particles”.

John Douglas Cockcroft
Ernest Walton

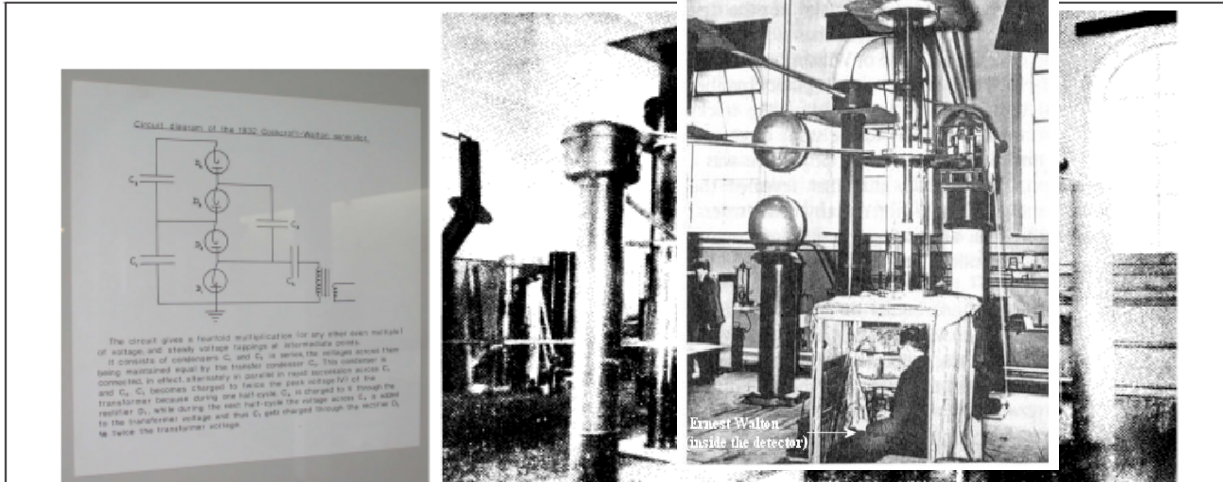
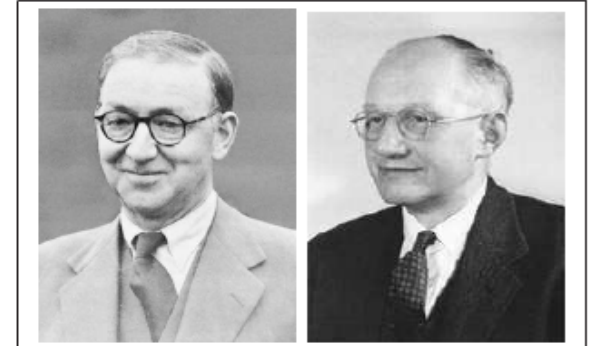

Voltage-multiplier circuitry and installation.

$\approx 700 \text{ kV}$ from a 200 kV transformer were obtained,
 $\sim 10 \mu\text{A}$ proton beam.

Penetration probability $1.8 \cdot 10^{-7}$ at 700 kV $\xrightarrow{10 \mu\text{A}}$ 10^7 events/s.

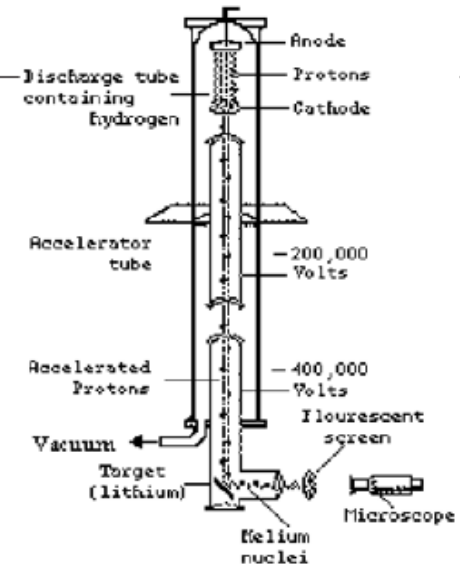

A scheme of C-W's 2-gap
accelerator column.

Potential for Li decay experiment
was $\sim 700 \text{ kV}$

Cockcroft-Walton (2/3), principle

The figure below shows principle assembly of (modern-style) Cockcroft-Walton voltage multiplier driven by AC voltage supply (left) and typical multi-electrode accelerator column (right).

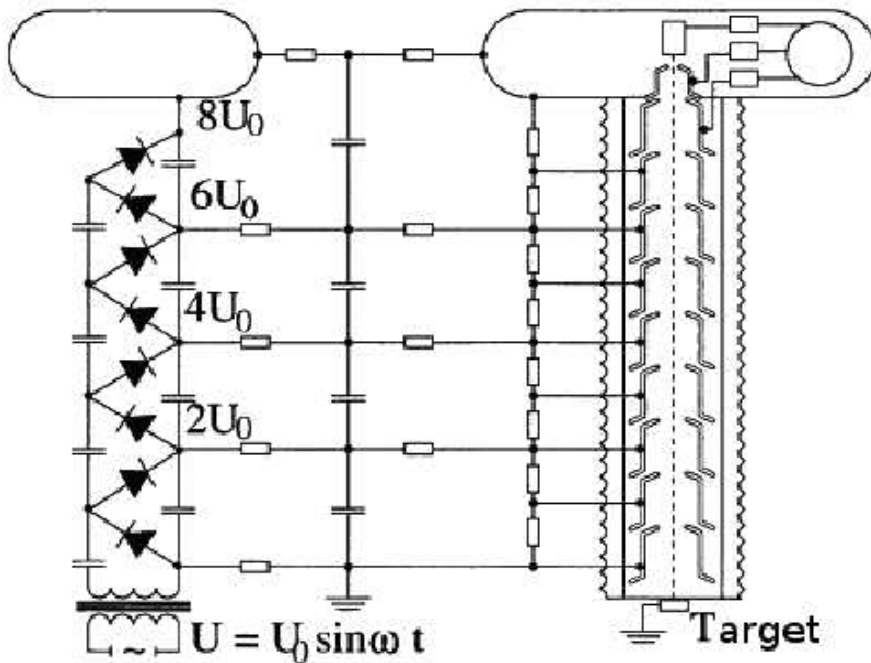

Nowadays technologies allow up to $U_{total} \sim 5$ MVolts, several tens mA DC (>100 kW beam).

Principles :

The maximum voltage is $2 \times n \times U_0$, plus a correction for current induced loss :

$$U_{total} = 2 \times n \times U_0 - \frac{2\pi I}{\omega C} \times f(n)$$

C = value of a capacitor

n = number of stages

I = ohmic loss + beam

$f \sim n^3$ polynomial dependence \Rightarrow limitation on n : voltage drop with I grows fast with the number of stages

It shows that large C and large ω reduce the effect of I on U_{total} .

Accelerator application : stability $\frac{\delta U_{tot}}{U_{tot}} \approx \frac{2\pi n^3}{RC\omega} \approx \text{few}\%$

Focusing : "cylindrical lens" principles

Exercise :

Take impedance $R \sim G\Omega$, capacity $C \sim nF$.

What is the order of magnitude of generator frequency $\omega/2\pi$ for $\frac{\delta U_{tot}}{U_{tot}} \sim 1\%$.

Response : kHz range.

Cockcroft-Walton (3/3)

- Cockcroft-Walton voltage multiplier is one amongst various other types of voltage multipliers
- A technique convenient in accelerator installations, still in use today in number of laboratories, at the front end of the injection chain.

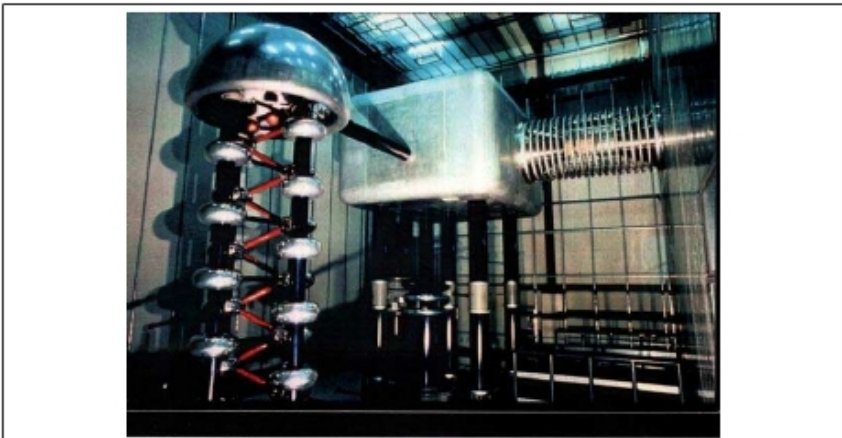

A modern version :
 the 810 kV, 30 mA Cockcroft-Walton injector at the PSI Mega-Watt cyclotron, using a voltage multiplier.

Exercise : value of n , U_0 ?
 Resp. : $n=5$, $U_0 \sim 80$ kV



FermiLab injector (source, C-W and transfer lines are doubled for minimal down-time).
 H-, 20 keV DC beam, accelerated to 750 keV prior to bunching and injection into a DTL.

And a trend, replacement by RFQ :
"[...] to reduce the maintenance requirements of the 750-keV pre-accelerator system, the replacement of the present Cockcroft-Walton accelerators with a single RFQ accelerator is proposed."
 (December 2008)

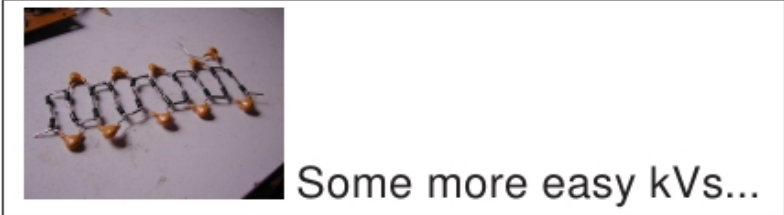

Some more easy kVs...

Van de Graaff (1/2)

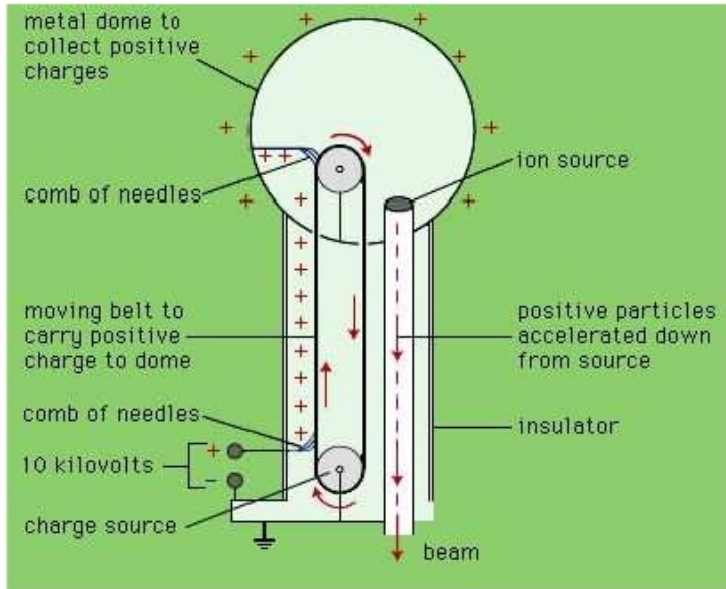

Van de Graaff electrostatic generator, principle : + or - charges, as brought by the insulating belt, are stored at the outer surface of the bulbe. Sharp points of combs are close to, but not touching, the belt, charges are transported from and to the belt by corona effect. Potential is used to accelerate particles.

- The Van de Graaff generator is simple, easy to regulate, capable of producing high voltages and therefore high accelerations of electrons or ions (compared at that time to Cockcroft-Walton).
- It is preferred when low ripple (low energy spread) is important at megavolt potentials.
- Intensity limited to ~mA.
- Effects limiting maximum achievable voltage are, size !, leakage, insulation, shape of electrodes...



In the company of its developer...

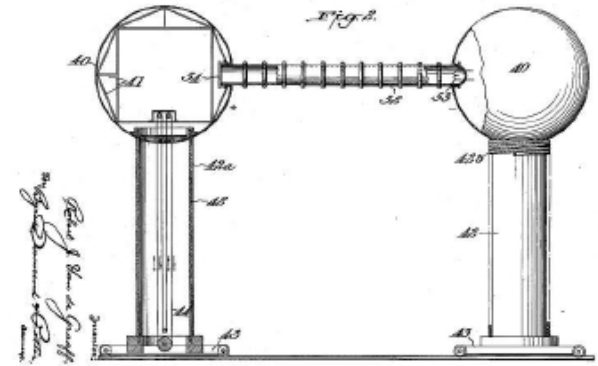

Patent figure, Dec. 1931.

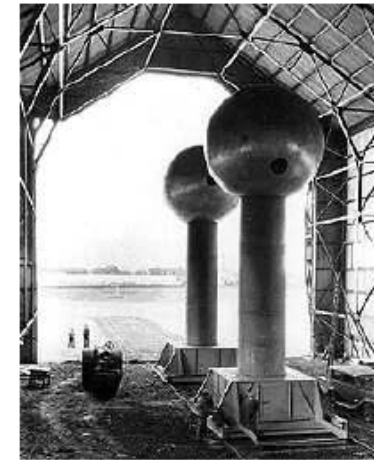

A 2 x 3.5 MV specimen, 1933.

Van de Graaff (2/2), Tandem

- There are nowadays hundreds of Van de Graaff accelerators over the world.
- Often under the form of “tandem Van de Graaff” : doubles available energy, and gas pressurised (isolating gas SF6, freon, several 10^5 Pa) : limit corona effects, reduce size, source and target at ground potential.

In the “Pelletron” (1960’s), a pellet chain replaces the belt and induction devices replace the needle combs (yields better stability, reliability...)

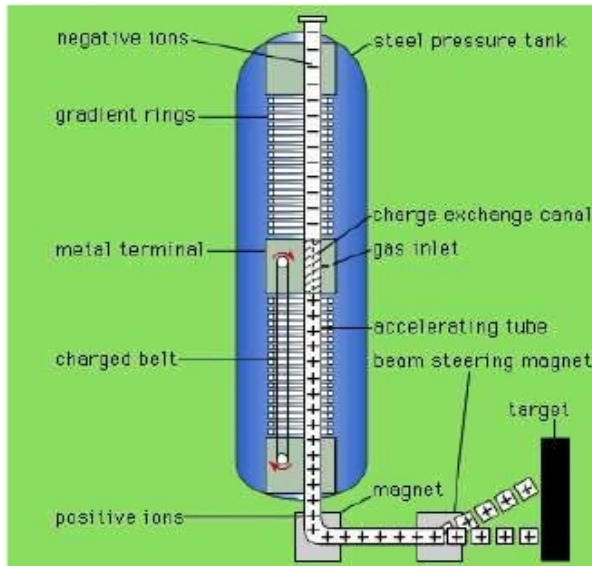

Two-stage - “tandem” - pressurized Van de Graaff.



One of the two (face-to-face) stages of the 15 MV Tandem-Van de Graaff at BNL. Can accelerate 40 different types of ions.



The tandem Van de Graaff at Western Michigan University, used for basic research, student training...



20 MV tandem VdG at Tandem Lab., Argentina (above), a smaller ancestor in earlier times (below).

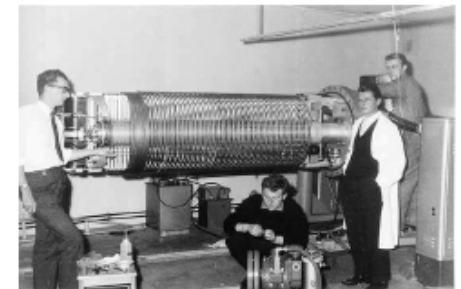

**LINEAR
RESONANT
ACCELERATORS**

Ising linac

- 1924: Ising proposes particle acceleration using a variable electric field between drift tubes
- The potential is applied to the gaps via wires (a1, a2, a3...) with adjusted lengths to ensure synchronism.
- Between gaps, particle bunchlets travel with constant velocity within drift tubes 1, 2, 3.
- It appeared not technologically possible to achieve a practical accelerator.
 - difficulty of spark excitation
 - inefficiency of wire transmission lines

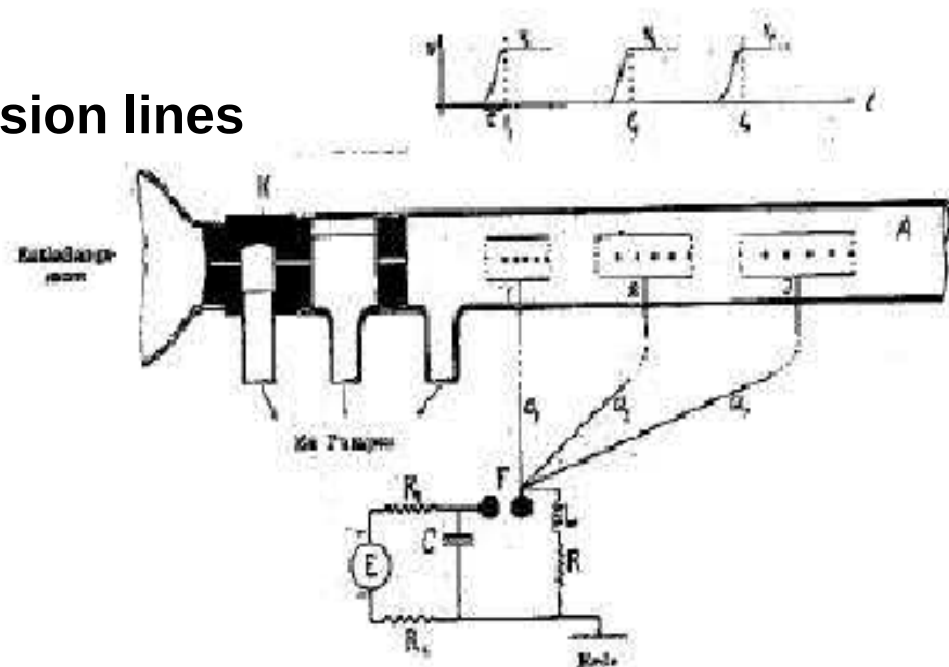

RESONANT ACCELERATION

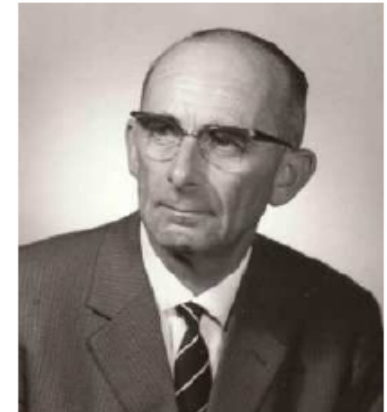

Wideroe linac (1/3)

- 1928, Rolf Wideroe in Berlin first demonstrates resonant acceleration by applying Ising principle using a 1 MHz, 25 kV generator, connected to drift tubes forming a series of successive gaps.
- He succeeds accelerating potassium ions in that structure, up to 50 keV,
- achieving the resonance required correlation between the various parameters : type of ion, RF frequency, applied potential, gap spacing.

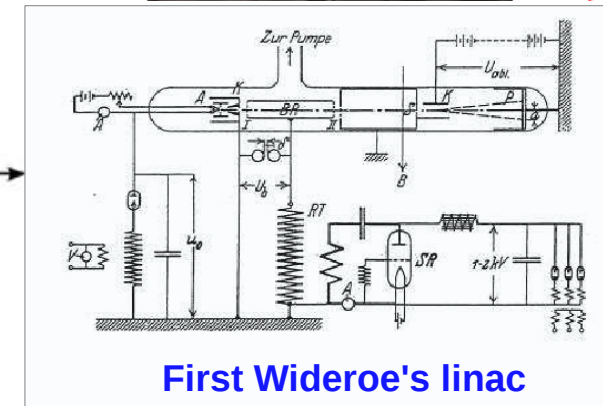
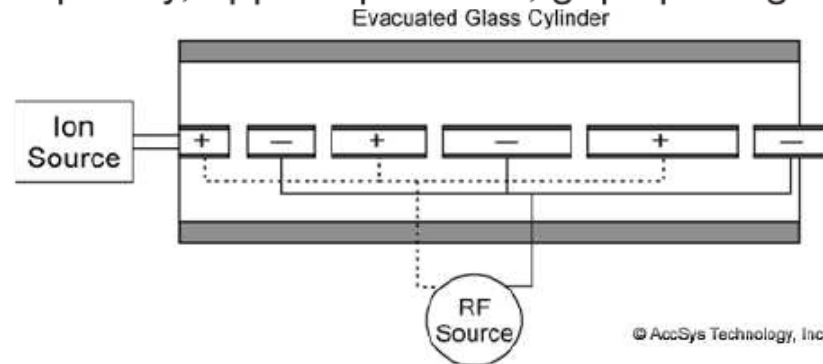

- Drift tubes with increasing length are arranged along beam propagation axis
They act like Faraday cage : bunch inside tube feels no field
- They are applied $U(t) = U_0 \sin(\omega t)$. At a given time, potential alternates from one gap to the next ("π" mode accelerating structure)
- $U(t)$ causes accelerating (or decelerating) gradient between tubes during half a period
- After n gap, a particle at (constant) phase ϕ with the wave has $E_n = nqU_0 \sin \phi$
- Distance between gaps n and $n+1$ is (with v_n =velocity, T =RF period = $2\pi/\lambda$)
 $d_n = v_n T/2 = \beta_n \lambda/2$
- A straightforward, fundamental effect of this resonance method is "beam bunching".

Alvarez linac (1/2)

- The development of radar technology during WWII offered pulsed, *high power*, up to GHz RF generators (“magnetron”, “klystron”), so allowing wavelengths in meter range (appropriate for ions $v/c < 1$) to cm range (electrons, $v \approx c$).
- 1946, L. Alvarez and coworkers at the Lawrence Berkeley Radiation Laboratory developed a proton linear accelerator based on injection of 200 MHz RF wave into a *resonant* metallic cylindrical cavity containing the wideroe-type drift tube arrangement.
 - the linac is injected with a 4 MeV electrostatic accelerator
 - protons are accelerated up to 32 MeV in the Alvarez structure

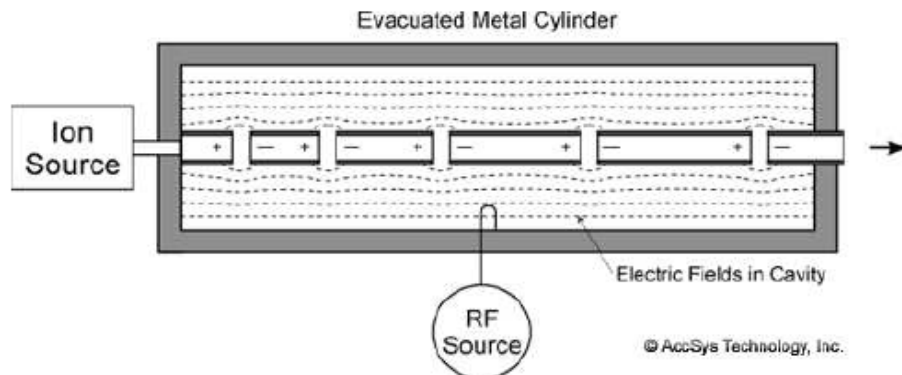

Remember, Wideroe's tubes were in a glass cylinder (strong antenna-like power losses), they were connected to an AC generator.

- Transverse focusing : ensured at gaps by grids shaping the (varying) E field.
- RF phasing : an accelerating standing wave fills the cavity. The particular resonant mode of interest (amongst oodles) is that with all gaps having the same polarity (“ $\beta\lambda$ ” or “ 2π ” accelerating mode)
- Evolutive geometry of the tubes (length & diameter) with distance causes cells to resonate on identical frequency.

Alvarez linac (2/2)

- Later on longitudinal focusing (phase stability) would be invented, ensuring best transmission. Transverse focusing today ensured with quadrupoles located in the drift tubes.
- DTLs are nowadays currently used as primary injection stages in hadron linac chains, or as injectors into synchrotrons.



202M Hz/70 MeV Alvarez injector linac at ISIS, RAL.

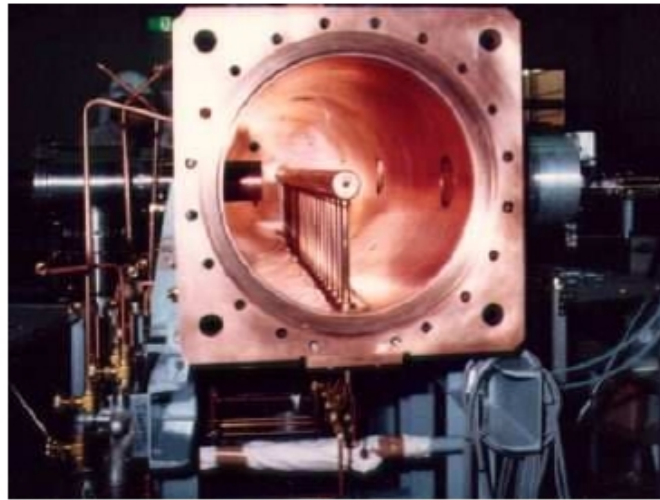

7 MeV Alvarez DTL, typical injector of medical synchrotron : pre-acceleration of protons or Carbons before injection into synchrotron.

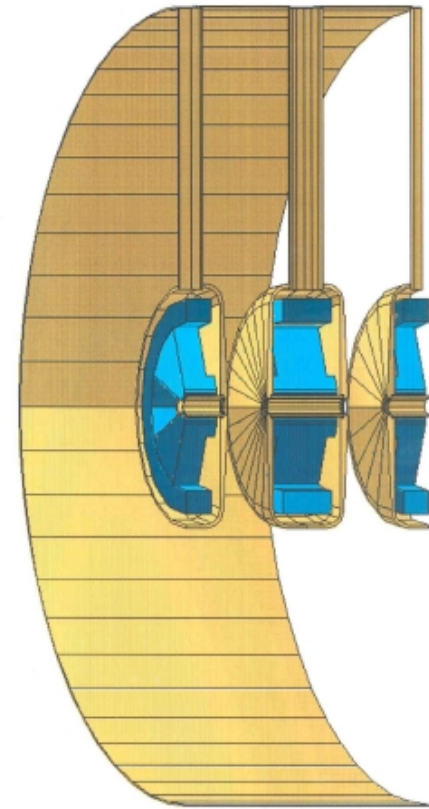

Quadrupoles in drift tubes.

RFQ

- Invented by M. Kapchinsky and V. Teplyakov in 1970.
- Invested accelerator installation front-ends from the late 70s
- Operation range: from 10s of keV injection to few MeV out of it
- Combined-function : it performs focusing, bunching, acceleration
- Used as an injector in many accelerator installations; used in industry

Reliable, compact,
all ions, high intensities



In many installations replaced that one

this injector

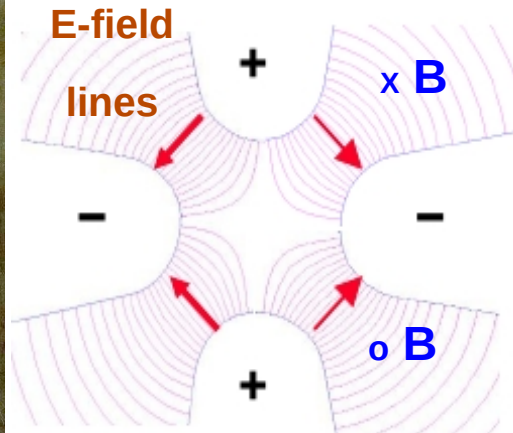
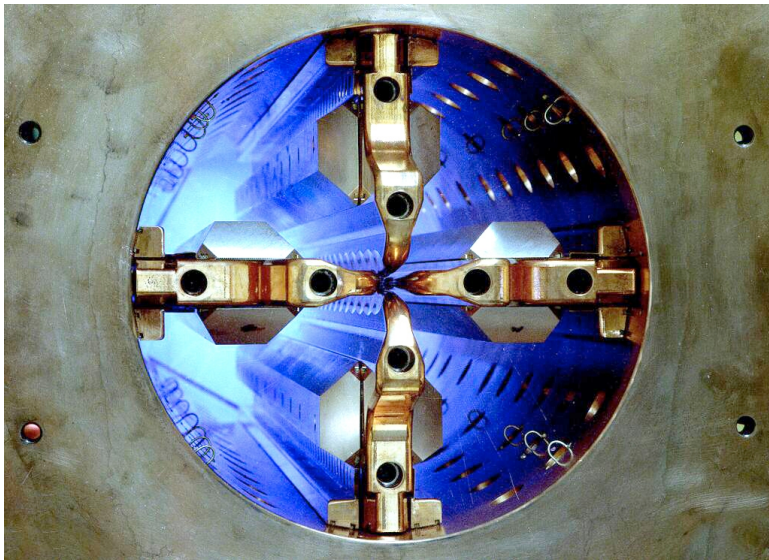

* PRODUCTION OF RADIOACTIVE ION BEAMS *

Cosmology, life sciences, nuclear physics

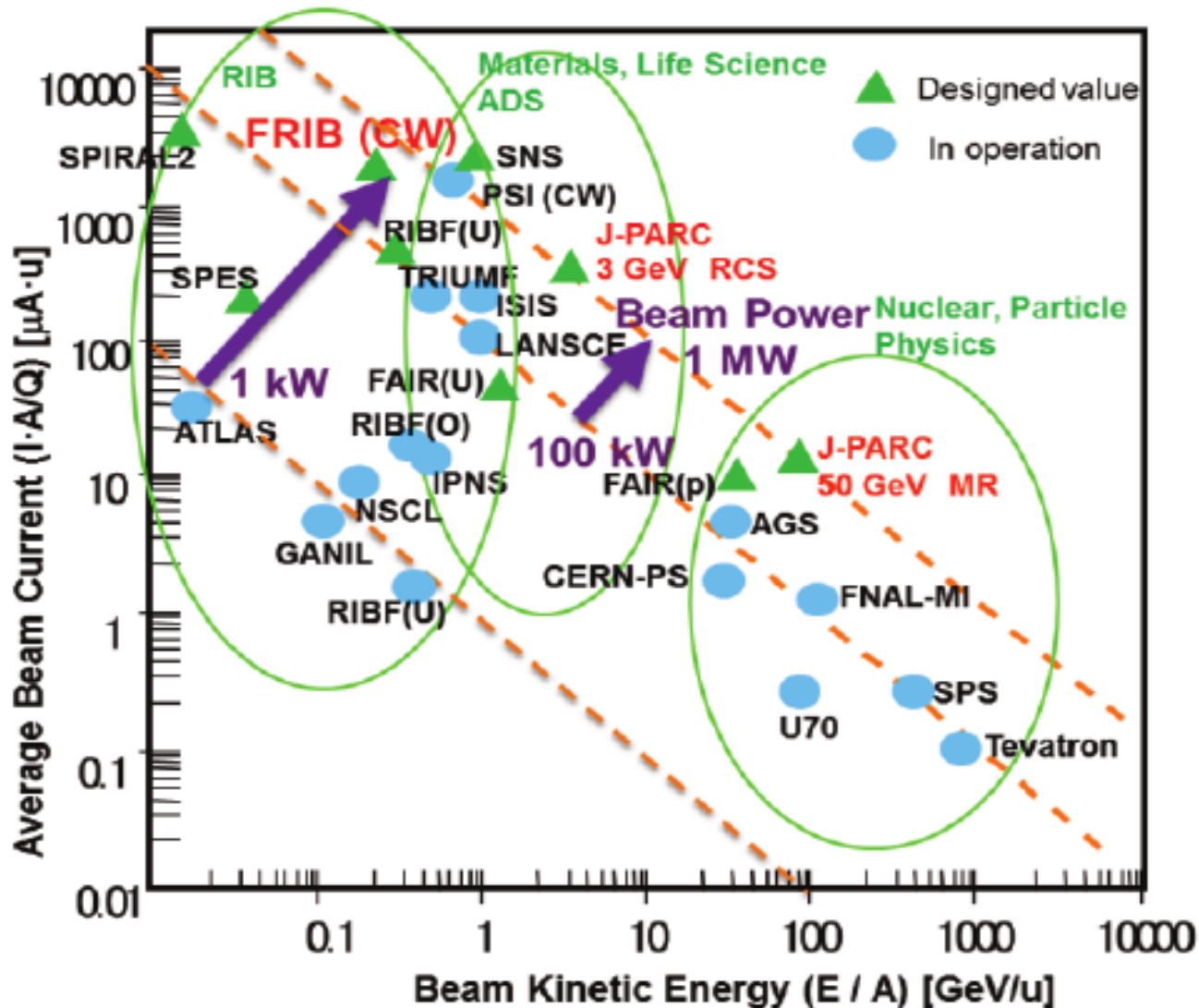

$$P[W] = U[eV] \times I[A]$$

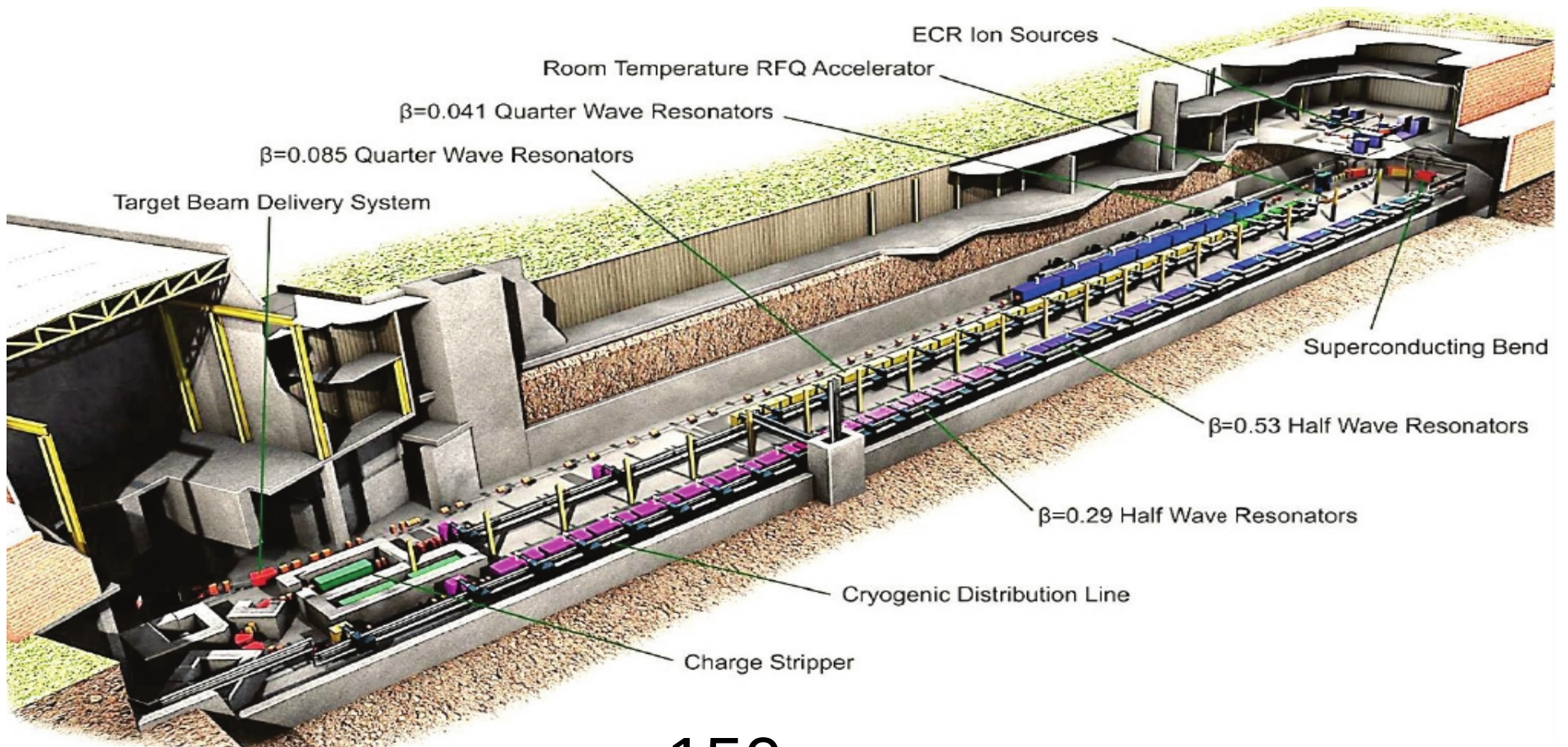

150 m

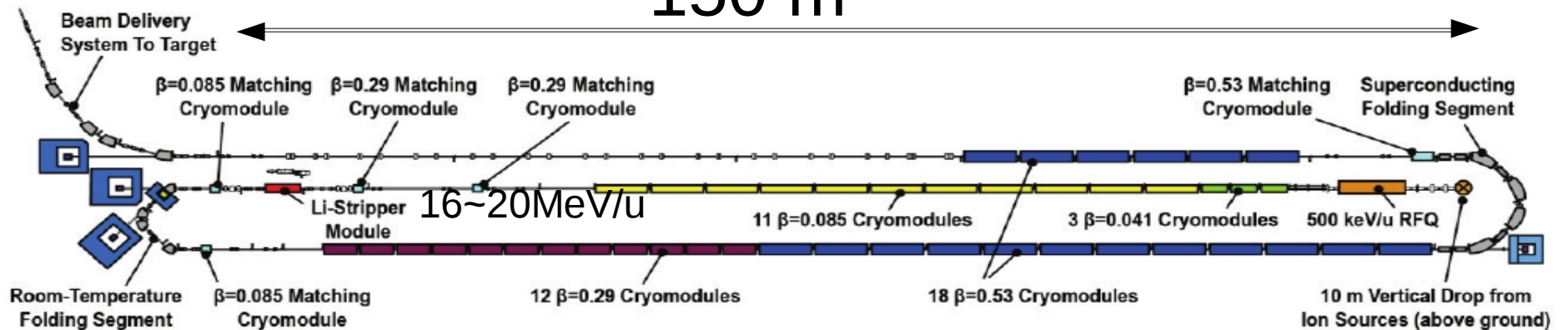

SOME FALL FOR “NON-LINEAR DYNAMICS”

Large acceptance to emittance ratios:

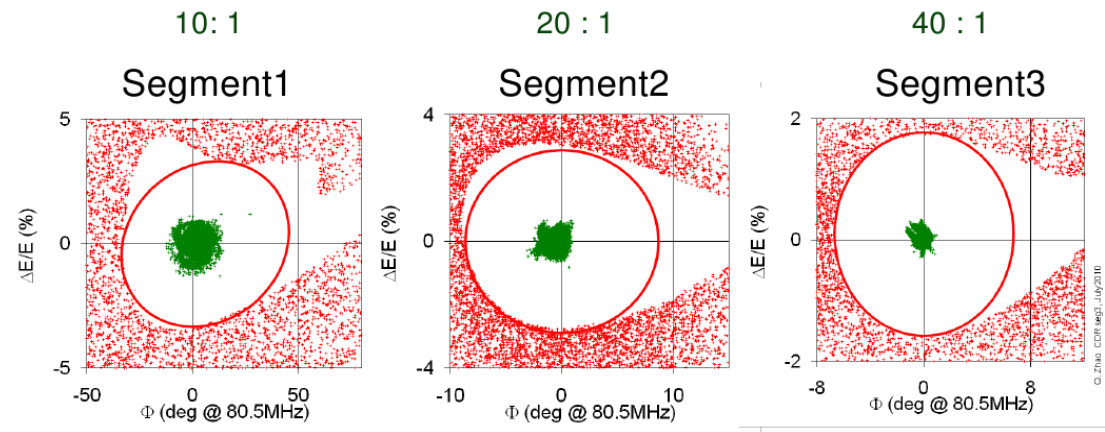

Owned
by ASD

- 1 Ion source, Low Energy Beam Transport (LEBT) (LEBT Faraday Cups (FCs))
- 2 RFQ + Medium Energy Beam Transport (MEBT) (MEBT FC)
- 3 LS1 ($\beta=0.041$ cryomodules) (temporary FC)
- 4 LS1 ($\beta=0.085$ cryomodules) (Beam Dump (BD) FS-1a)
- 5 Stripper, FS1, charge selection (BD FS-1b, temporary FC)
- 6 LS2, FS2 (BD FS-2, temporary FC)
- 7 LS3 (BD Beam Delivery System (BDS))
- 8 BDS (target)
- 9 Fragment separator (target)

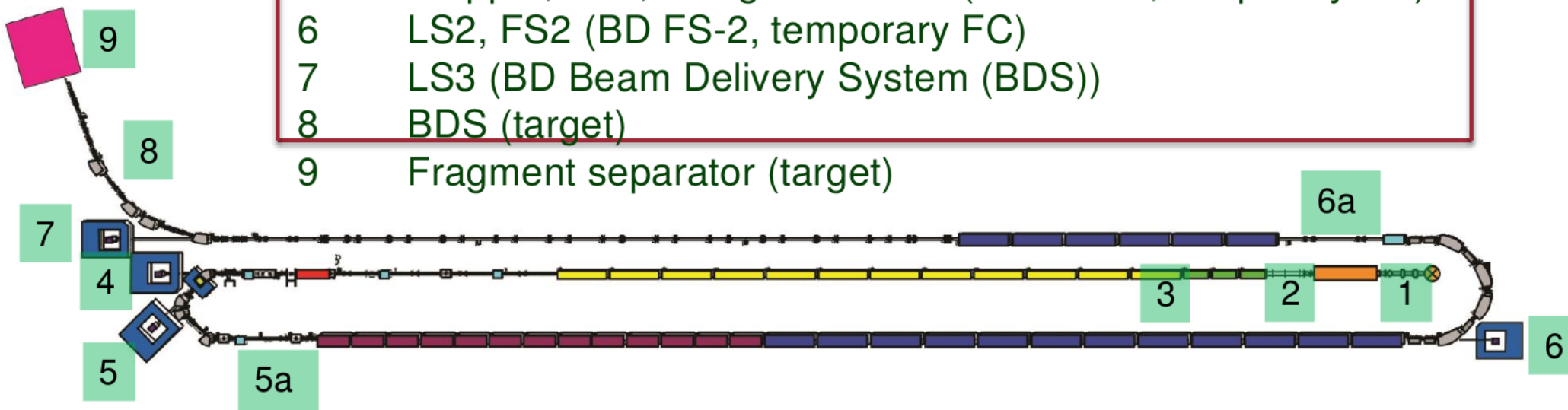

SUPER-CONDUCTING RF TECHNOLOGIES

FRIB Linac SRF Cavities

- Only 4 cavity types
- 1 frequency transition (between Linac Segment 1 and 2)

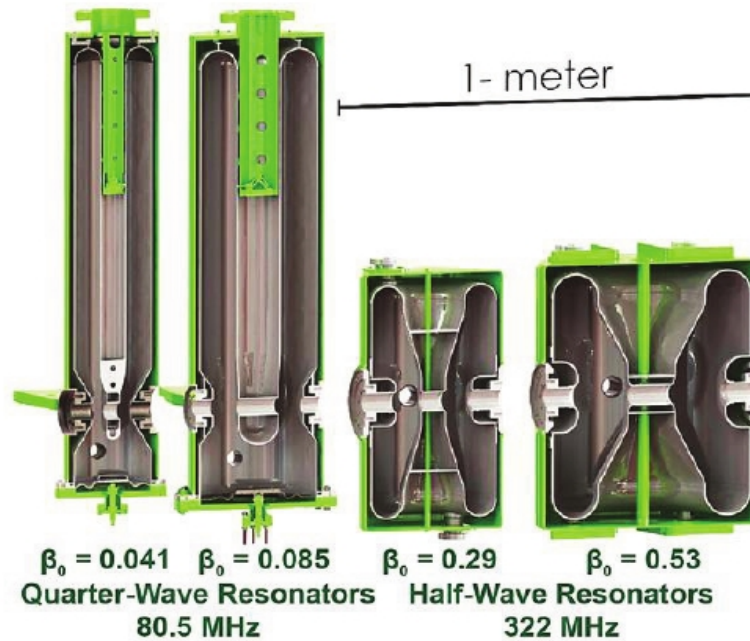

$\beta=0.85$



$\beta=0.53$

| Type | $\lambda/4$ | $\lambda/4$ | $\lambda/2$ | $\lambda/2$ |
|---------------|-------------|-------------|-------------|-------------|
| β_{opt} | 0.041 | 0.085 | 0.29 | 0.530 |
| f(MHz) | 80.5 | 80.5 | 322 | 322 |
| Aperture (mm) | 30 | 30 | 30 | 40 |
| V_a (MV) | 0.81 | 1.62 | 1.90 | 3.70 |
| E_p (MV/m) | 30.0 | 31.5 | 31.5 | 31.5 |
| B_p (mT) | 53 | 71 | 75 | 77 |
| T(K) | 4.5 | 4.5 | 2.0 | 2.0 |

* ACCELERATOR-DRIVEN SUBCRITICAL REACTOR *

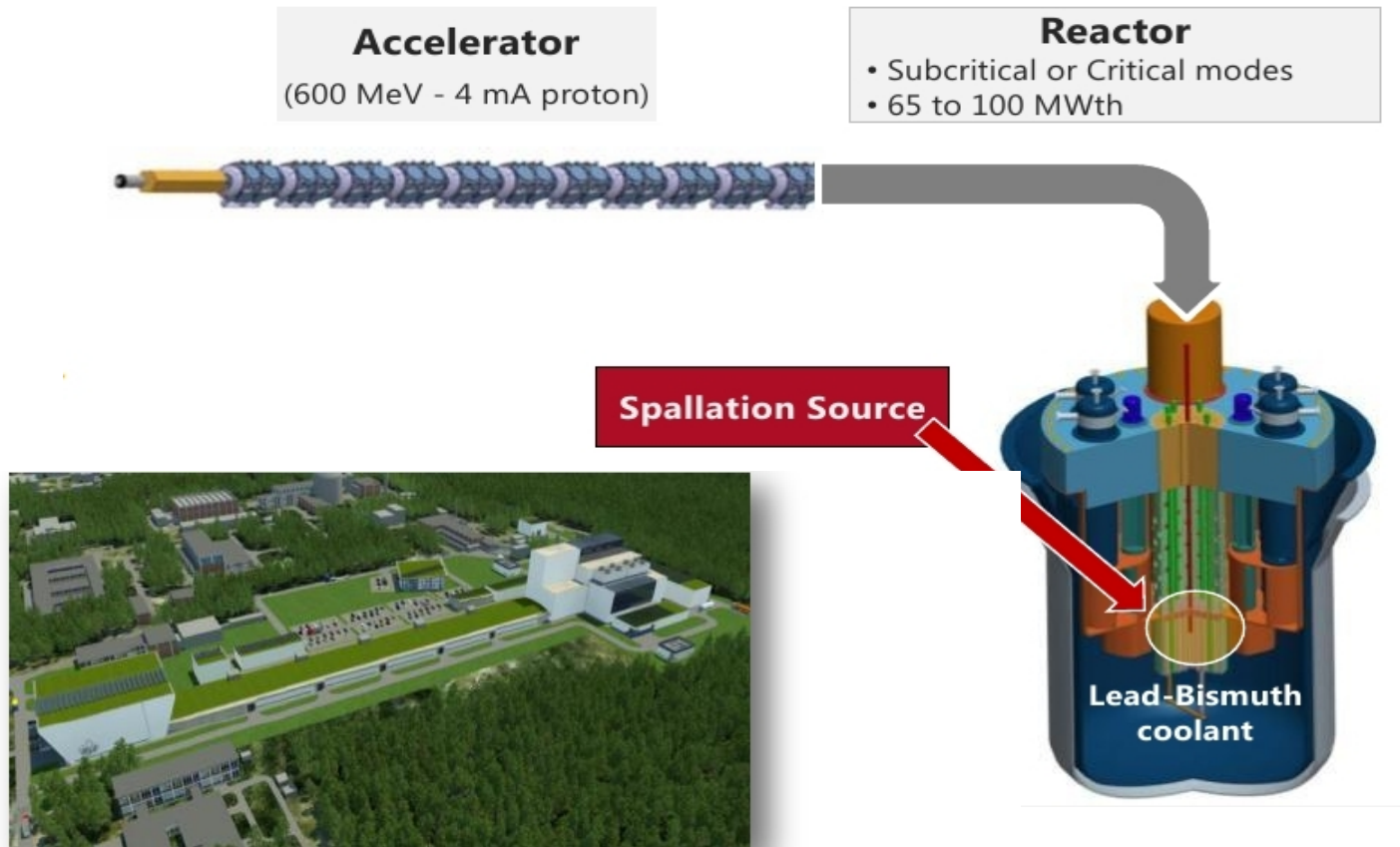

MYRRHA

Multipurpose **h**ybrid **R**esearch **R**eactor for **H**igh-tech **A**pplications
A flexible and fast spectrum irradiation facility

- **Required beam power P_B , for P_{th} reactor power :**
With beam energy $E_B \approx 1$ GeV, a handy estimate is

$$P_B \approx \frac{1}{2}(1 - k_{\text{eff}}) P_{\text{th}}$$

$$P_B = E_B \frac{P_{\text{th}} (1 - k_{\text{eff}})}{f E_f k_{\text{eff}}} \left\{ \begin{array}{l} k_{\text{eff}} = \text{neutron multiplication factor} = \frac{\text{n produced}}{\text{n absorbed}} \approx 0.95 - 1^- \\ E_f = \text{fission energy} \approx 200 \text{ MeV} \\ f = \text{fraction of neutrons causing fission} \approx \frac{1\text{GeV-p } 20\text{n/incident p}}{2.5\text{n/fission}} \end{array} \right.$$

- k_{eff} is central to the accelerator parameters, the closer it is to 1, the lower the beam power to be brought in - but, drawback, the closer the reactor core to critical.

| - Typical numbers - | | | |
|--------------------------------------|--------------------------|------------------|---|
| | ADS thermal power | k_{eff} | Proton beam Energy / Current / Power |
| Demo transmuter MYRRHA: | 50-100 MW-th | ≈ 0.95 | 600 MeV / 4 mA / 2.4 MW |
| EFIT industrial transmuter: | several 100 MW-th | ≈ 0.97 | 800 MeV / 20 mA / 16 MW |
| China's demonstrator program: | 1000 MW-th | | 1.5 GeV / 10 mA / 10 MW |

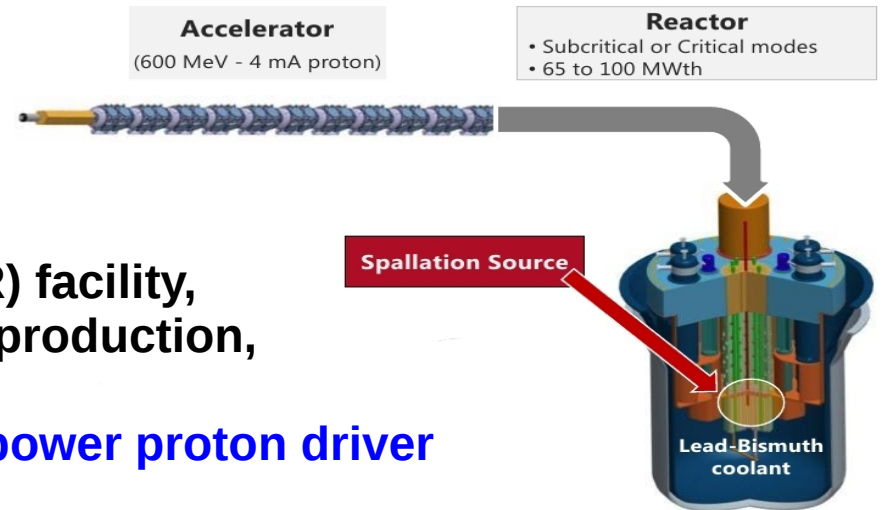

- An accelerator driven sub-critical reactor (ADS-R) facility, aimed at nuclear waste treatment and/or energy production, is comprised of three ensembles: **a sub-critical reactor, a spallation target, a high power proton driver**
- The reactor is operated in the sub-critical regime, with a neutron multiplication factor $k_{eff} = \text{number of neutrons produced} / \text{number of neutrons absorbed} \approx 0.95-0.98$

(the design of the European MYRRHA for instance, features $k_{eff} \approx 0.95$, a 0.03 downgrade from 0.98, i.e., the maximum authorized for nuclear compounds storage, accounting for diverse possible incidental reactivity effects, with causes such as misloading, void coefficient perturbations, etc.).
- A high-power proton beam provided by the accelerator installation bombards a spallation target to provide a supply of neutrons to drive the subcritical reaction.
- For a proton beam in the $E \approx 1 \text{ GeV}$ range, the required beam power to produce a reactor thermal power P_{th} , is given with reasonable approximation by
$$P_b \approx 0.5 (1 - k_{eff}) P_{th}.$$
- k_{eff} is central to the accelerator parameters, the closer it is to 1, the lower the beam power required to produce the spallation reaction, but the closer the reactor core is to criticality.

*** neutron production ***
This is the front today

SNS, Oak Ridge



ESS, Lund, Sweden



spallation NEUTRONS

- Flux, in modern research reactors, typically: 10^{15} /cm²/s
- From spallation sources, i.e., accelerators : 10^{17} /cm²/s

A greater flux reduces the time required to conduct an experiment.

(Similar leap in many other sectors, e.g., photons from X-ray tubes versus light sources)

- The two technologies, reactor and accelerator, compete today.

Drawback of the reactor method : requires highly enriched U235, 20%, in some cases “weapon grade” EU, 93% U235.

There are programs to switch to LEU, though... that's another story !

**SNS, operates since 2006,
the largest, highest power, *linear*, proton accelerator in the world**



| | | |
|------------------------|-----------|----------------------|
| Commissioning | | 2006 |
| SCL linac length | m | 180 |
| Kinetic energy | GeV | 1 |
| Beam power | MW | 1.4 |
| Repetition rate | Hz | 60 |
| Duty factor (Df) | % | 6 |
| Peak current (Ip) | mA | 38 |
| Average current | mA | 1.6 |
| Ring accumulation | turn s | 1060 |
| Ring peak current | A | 25 |
| Ring bunch population | ppp | 1.5 10 ¹⁴ |
| Pulse length at target | μs | 0.7 |



$$I = Qf = ppp * e / (C/c)$$

[1] <https://neutrons.ornl.gov/instruments>

SNS

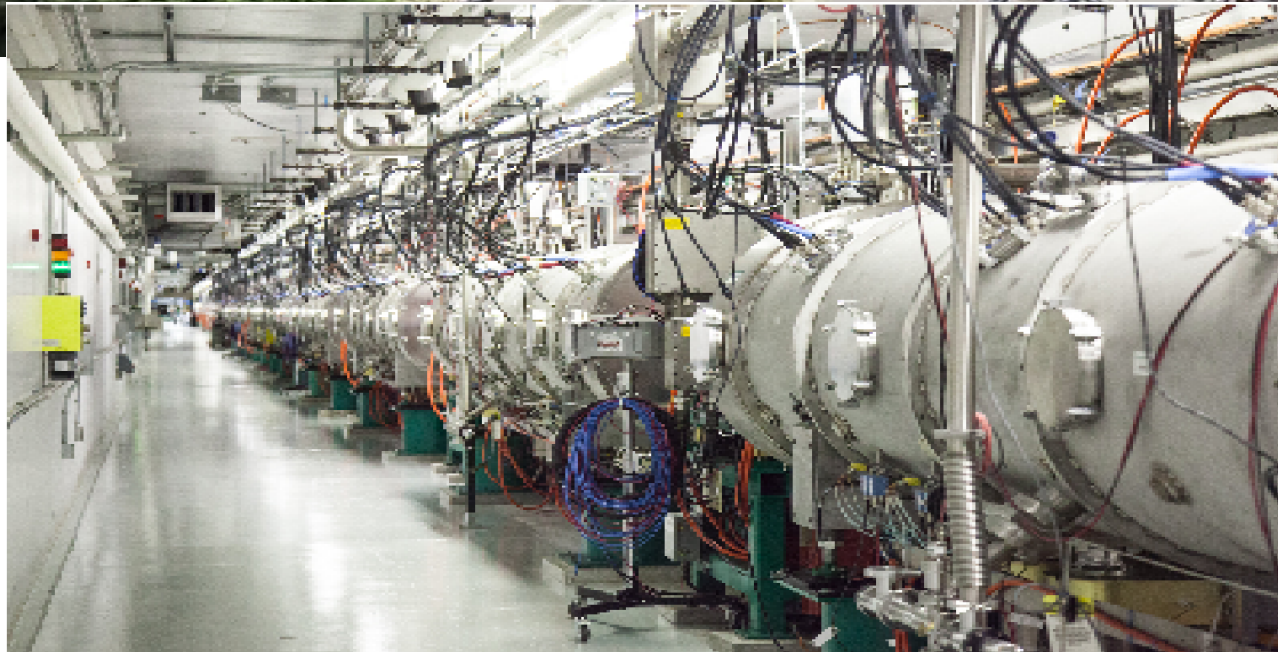

Where SNS 1.4 MW proton beam ends up

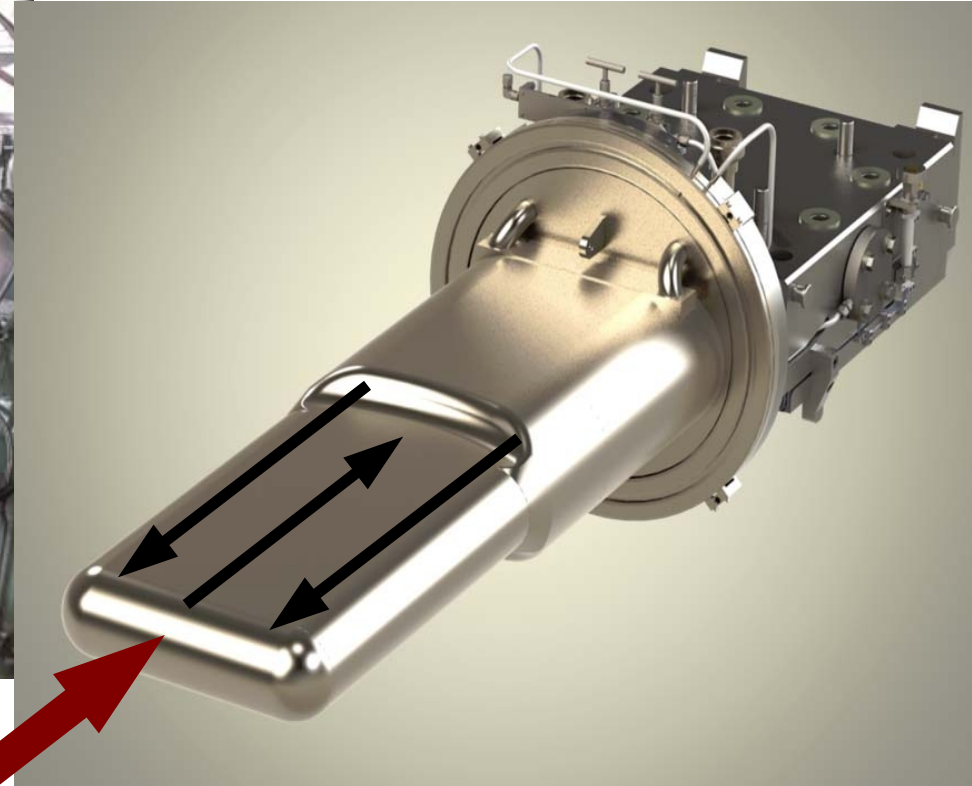

SNS TARGET - Inside the target vessel, a mercury jet.

p
beam

When a high-energy proton hits the nucleus of a Hg atom, 20 to 30 neutrons are "spalled" or thrown off.

Those neutrons are guided out of the target vessel into beam guides that lead directly to instrument stations. The neutrons coming out of the target must be turned into low-energy neutrons suitable for research—that is, they must be moderated to room temperature or colder.

The neutrons emerging from the target are slowed down by passing them through cells filled with water (to produce room-temperature neutrons) or through containers of liquid hydrogen at a temperature of 20 K (to produce cold neutrons). These moderators are located above and below the target.

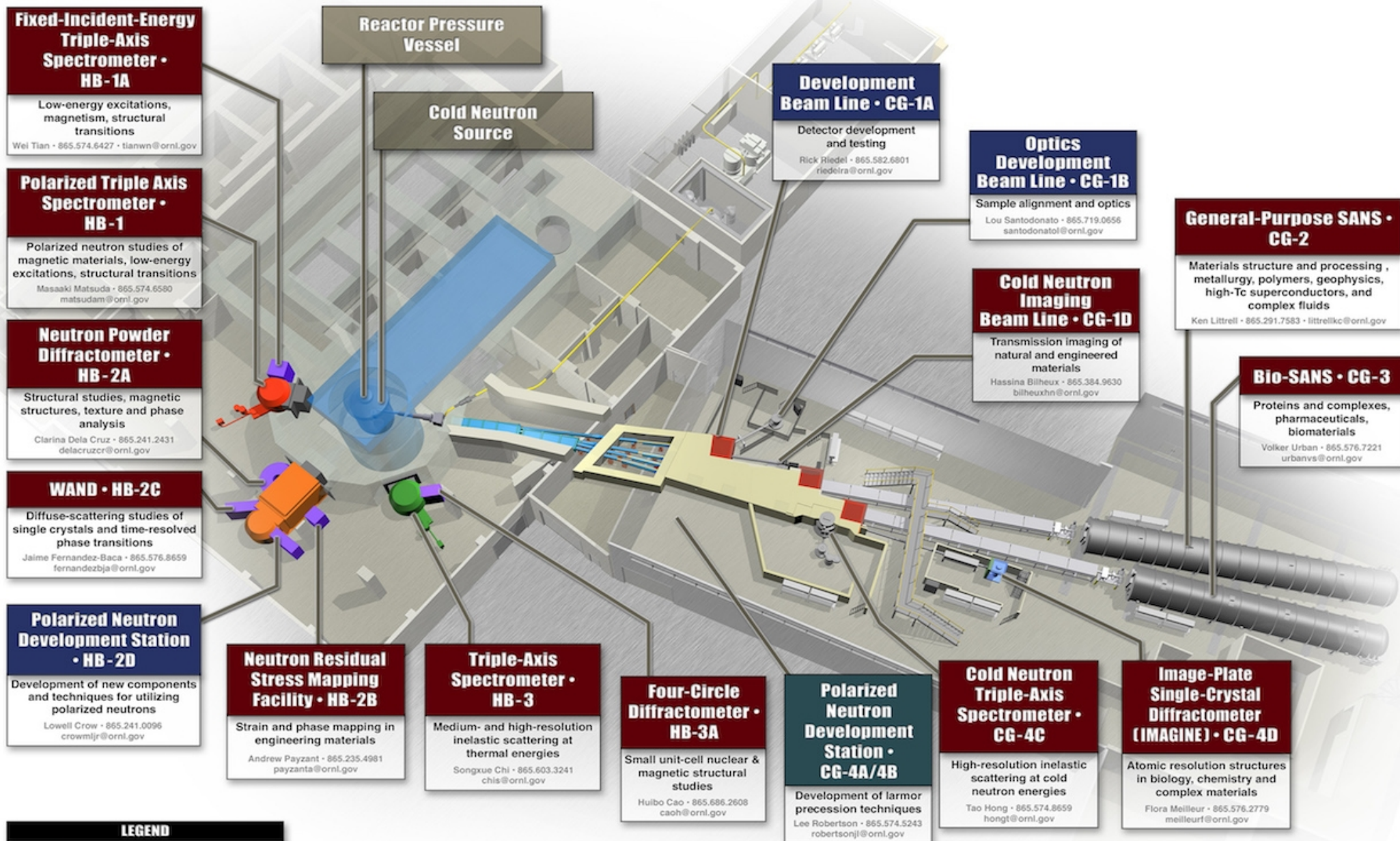

LEGEND

- Operating instrument in user program
- In commissioning or operating development beamline
- In design or construction
- Under consideration

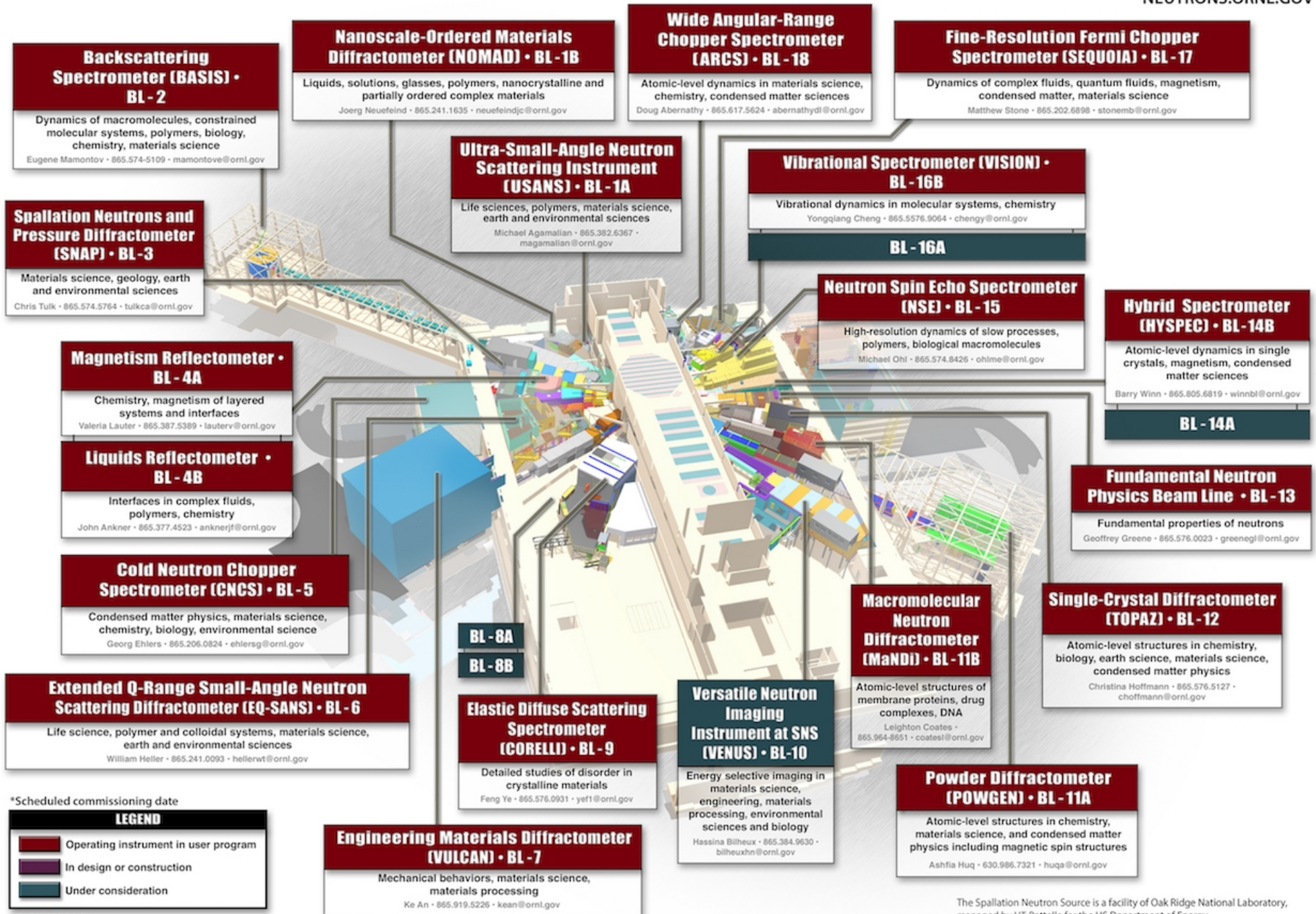

Backscattering Spectrometer (BASIS) • BL - 2

Dynamics of macromolecules, constrained molecular systems, polymers, biology, chemistry, materials science

Eugene Mamontov • 865.574.5109 • mamontov@ornl.gov

Nanoscale-Ordered Materials Diffractometer (NOMAD) • BL - 1B

Liquids, solutions, glasses, polymers, nanocrystalline and partially ordered complex materials

Joerg Neufeind • 865.241.1635 • neufeindjc@ornl.gov

Wide Angular-Range Chopper Spectrometer (ARCS) • BL - 18

Atomic-level dynamics in materials science, chemistry, condensed matter sciences

Doug Abernathy • 865.617.5624 • abernathydl@ornl.gov

Fine-Resolution Fermi Chopper Spectrometer (SEQUOIA) • BL - 17

Dynamics of complex fluids, quantum fluids, magnetism, condensed matter, materials science

Matthew Stone • 865.202.6898 • stonemb@ornl.gov

Spallation Neutrons and Pressure Diffractometer (SNAP) • BL - 3

Materials science, geology, earth and environmental sciences

Chris Tulk • 865.574.5764 • tulkca@ornl.gov

Ultra-Small-Angle Neutron Scattering Instrument (USANS) • BL - 1A

Life sciences, polymers, materials science, earth and environmental sciences

Michael Agamalian • 865.382.6367 • magamalian@ornl.gov

Vibrational Spectrometer (VISION) • BL - 16B

Vibrational dynamics in molecular systems, chemistry

Yongqiang Cheng • 865.5576.9064 • chengy@ornl.gov

BL - 16A

Neutron Spin Echo Spectrometer (NSE) • BL - 15

High-resolution dynamics of slow processes, polymers, biological macromolecules

Michael Ohl • 865.574.8426 • ohlme@ornl.gov

Hybrid Spectrometer (HYSPEC) • BL - 14B

Atomic-level dynamics in single crystals, magnetism, condensed matter sciences

Barry Winn • 865.805.6819 • winnbl@ornl.gov

BL - 14A

Magnetism Reflectometer • BL - 4A

Chemistry, magnetism of layered systems and interfaces

Valeria Lauter • 865.387.5389 • lauterv@ornl.gov

Liquids Reflectometer • BL - 4B

Interfaces in complex fluids, polymers, chemistry

John Ankner • 865.377.4523 • anknerjf@ornl.gov

Cold Neutron Chopper Spectrometer (CNCS) • BL - 5

Condensed matter physics, materials science, chemistry, biology, environmental science

Georg Ehlers • 865.206.0824 • ehlersg@ornl.gov

BL - 8A
BL - 8B

Elastic Diffuse Scattering Spectrometer (CORELLI) • BL - 9

Detailed studies of disorder in crystalline materials

Feng Ye • 865.576.0931 • yef1@ornl.gov

Versatile Neutron Imaging Instrument at SNS (VENUS) • BL - 10

Energy selective imaging in materials science, engineering, materials processing, environmental sciences and biology

Hassina Bilheux • 865.384.9630 • bilheuxhn@ornl.gov

Macromolecular Neutron Diffractometer (MaNDI) • BL - 11B

Atomic-level structures of membrane proteins, drug complexes, DNA

Leighton Coates • 865.964.8651 • coatesl@ornl.gov

Single-Crystal Diffractometer (TOPAZ) • BL - 12

Atomic-level structures in chemistry, biology, earth science, materials science, condensed matter physics

Christina Hoffmann • 865.576.5127 • choffmann@ornl.gov

Fundamental Neutron Physics Beam Line • BL - 13

Fundamental properties of neutrons

Geoffrey Greene • 865.576.0023 • greenejl@ornl.gov

Extended Q-Range Small-Angle Neutron Scattering Diffractometer (EQ-SANS) • BL - 6

Life science, polymer and colloidal systems, materials science, earth and environmental sciences

William Heller • 865.241.0093 • hellerwt@ornl.gov

Engineering Materials Diffractometer (VULCAN) • BL - 7

Mechanical behaviors, materials science, materials processing

Ke An • 865.919.5226 • kean@ornl.gov

Powder Diffractometer (POWGEN) • BL - 11A

Atomic-level structures in chemistry, materials science, and condensed matter physics including magnetic spin structures

Ashfia Huq • 630.986.7321 • huqa@ornl.gov

*Scheduled commissioning date

LEGEND

- Operating instrument in user program
- In design or construction
- Under consideration

ESS, currently under construction, in Lund, Sweden, will be the world most powerful neutron source

| | | | |
|---------------------------------|-----|------|-------------------------------------|
| Linac length, overall | m | | |
| Kinetic energy | GeV | 2 | proton |
| Beam power | MW | 5 | |
| Repetition rate | Hz | 14 | |
| Duty factor (Df) | % | 4 | |
| Pulse current (I _p) | mA | 62.5 | |
| Average current | mA | 2.5 | I _p x Df ~ 38[mA] x 6[%] |
| target | ms | 2.86 | |

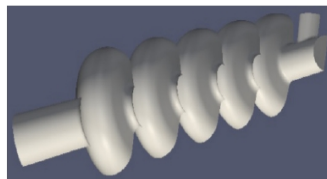
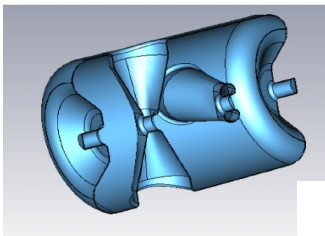
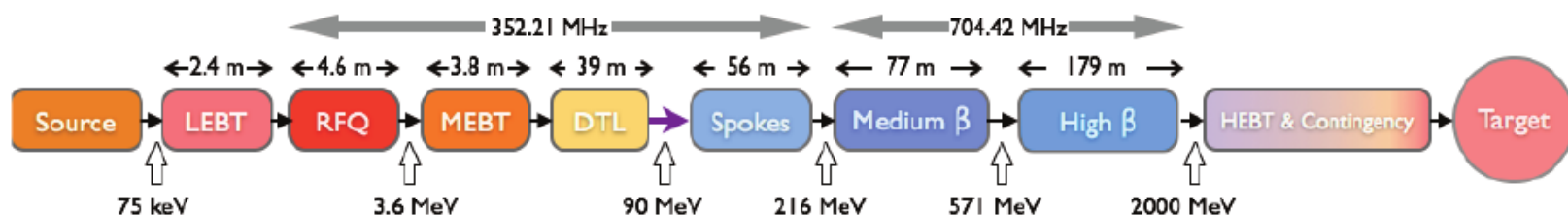

Figure 4: High β elliptical cavity proposed for ESS.



A great complexity

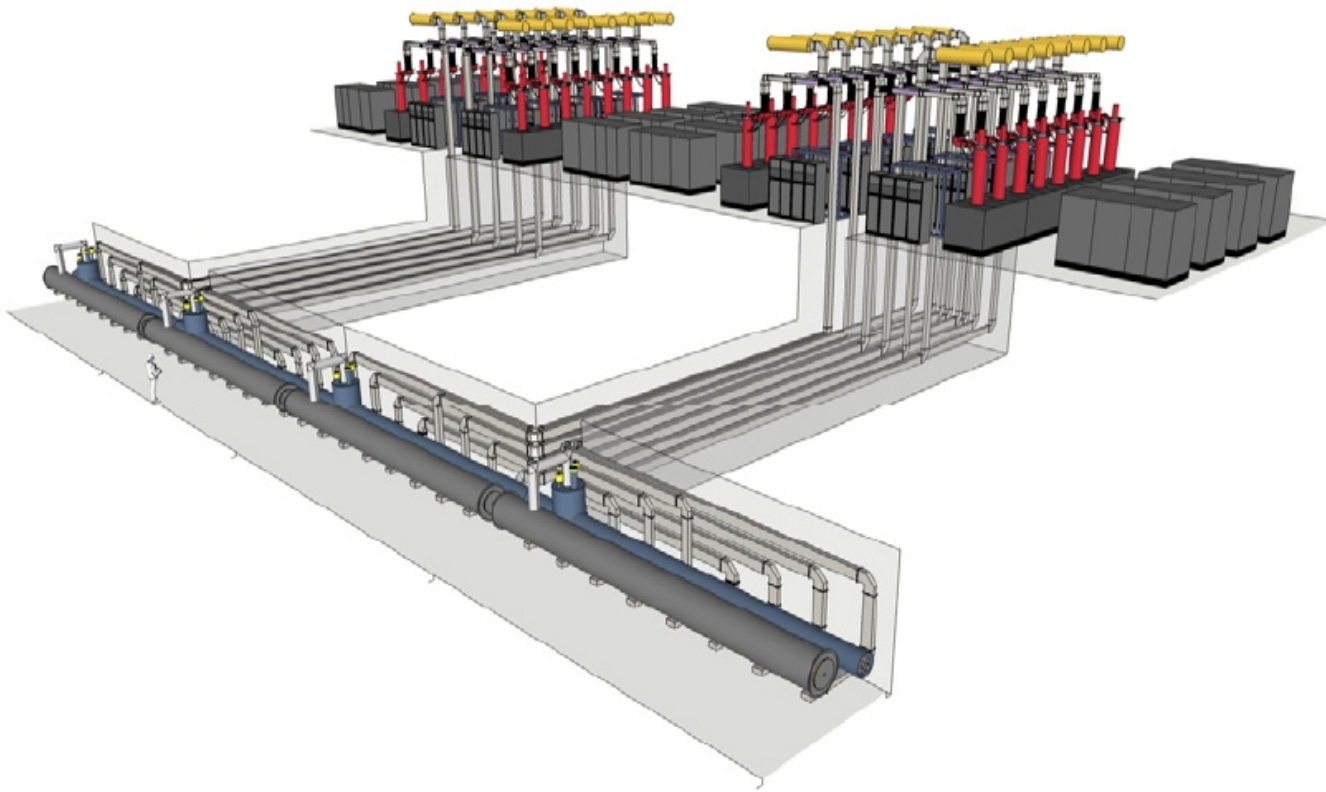
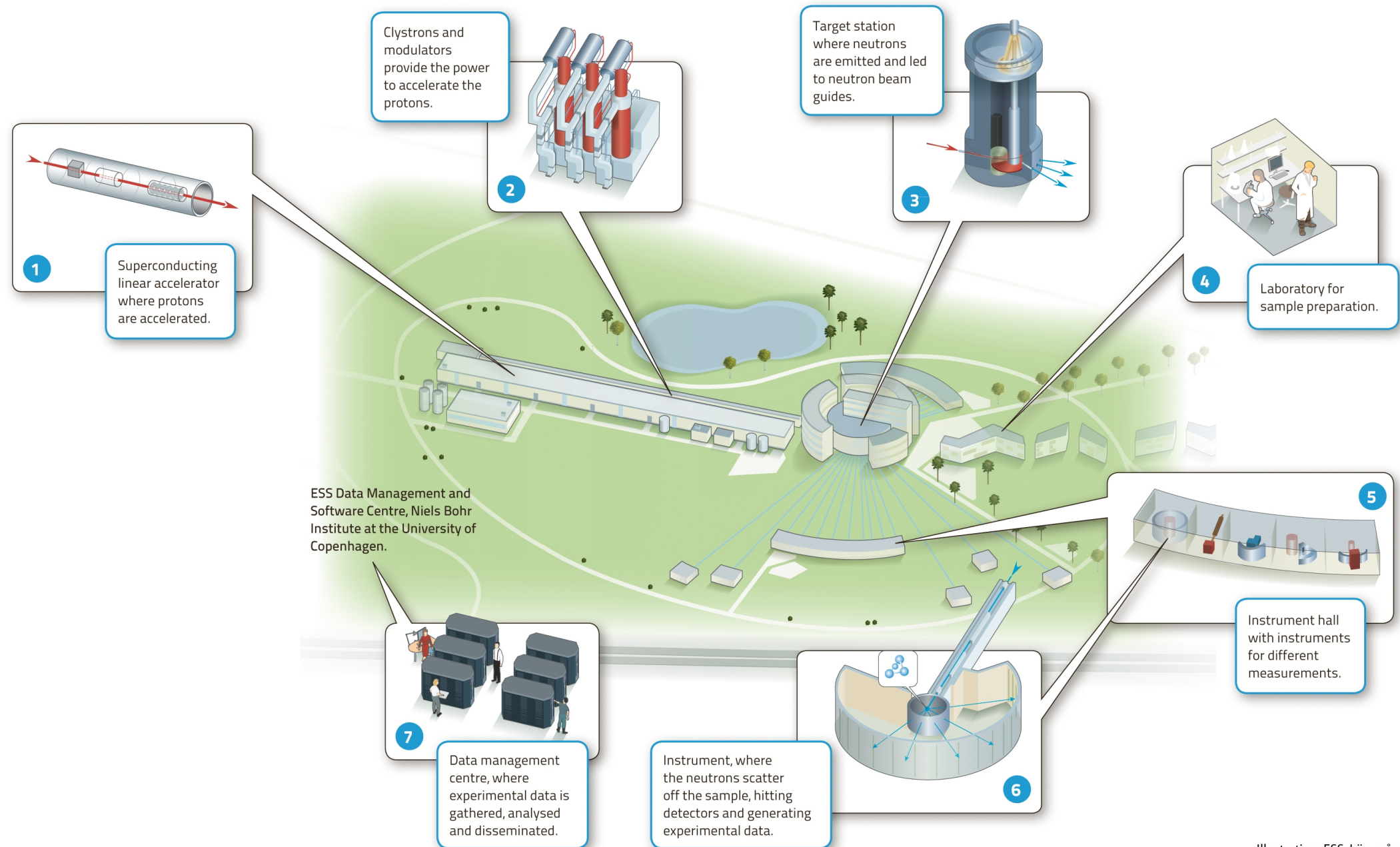
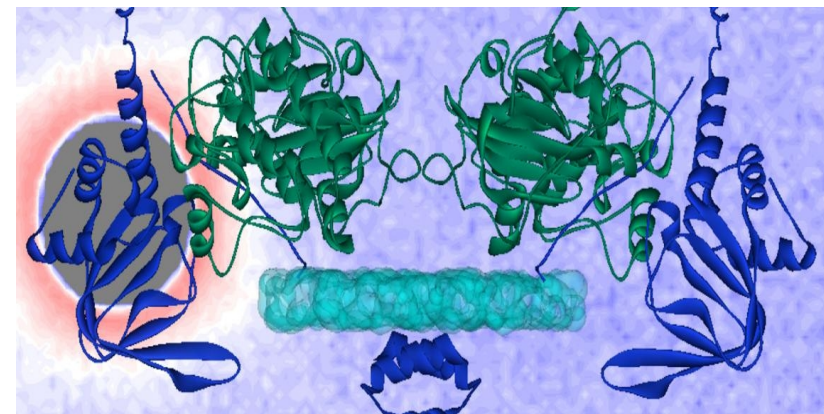

Figure 4: Layout of RF gallery (top right) and linac tunnel (bottom left) with waveguides between klystrons and cryomodules.

How is an sns organized ?



- A spallation neutron source provides the most intense pulsed neutron beams, for scientific research and industrial development.
- Researches cover a broad range of disciplines, such as physics, chemistry, materials science, biology. Neutron scattering community performs there measurements of greater sensitivity, higher speed, higher resolution, and in more complex sample environments than have been possible at existing neutron facilities.



A neutron source and its complementary detection instruments can be compared with a giant microscope for the study of materials – from plastics and pharmaceuticals, to engines, and molecules.

X-LASER

actually known as

FEL

or

SASE-FEL

Main interest :

Laser-like X-photon beams

Potential for femto-second X-pulse source

FEL [wiki] :

- The widest frequency range of any laser type
- Widely tunable
- Designs allow wavelengths in microwave region, or terahertz, infrared, the visible spectrum, ultraviolet, X-ray with highest electron beam energies
- The term free-electron lasers was coined by John Madey in 1976 at Stanford University
- The work emanates from researches done by Hans Motz and his coworkers. They built an [undulator](#) at Stanford in 1953, using the wiggler magnetic configuration which is the heart of a free electron laser
- Madey used a 43-MeV electron beam and 5 m long wiggler to amplify a signal

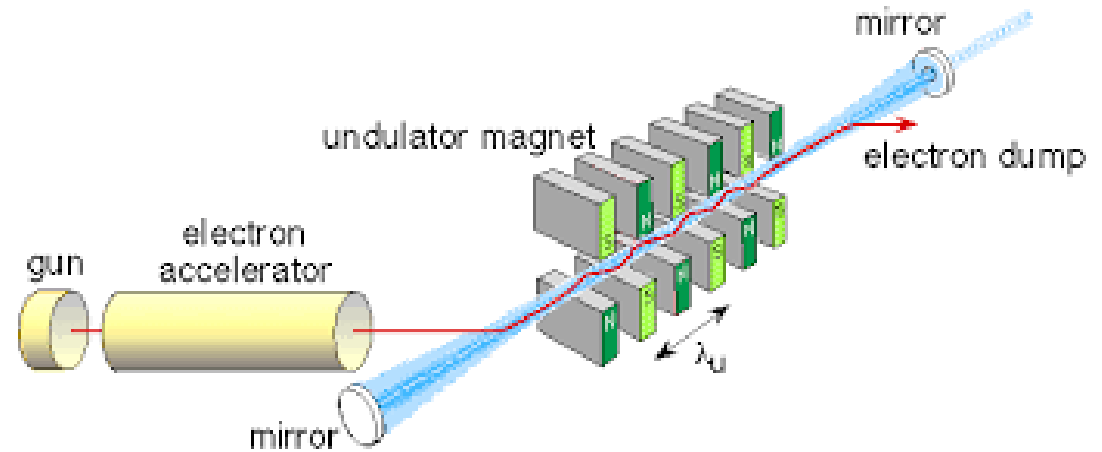

Principle of “undulator radiation”

Electron beam, from ring or linac

A long string (meters) of ~cm scale magnetic periods wiggles the e-beam over meters

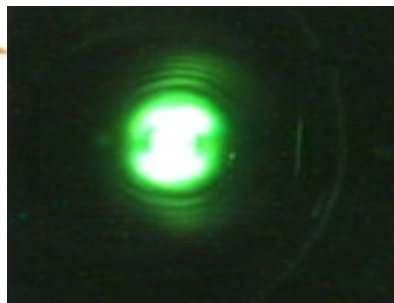
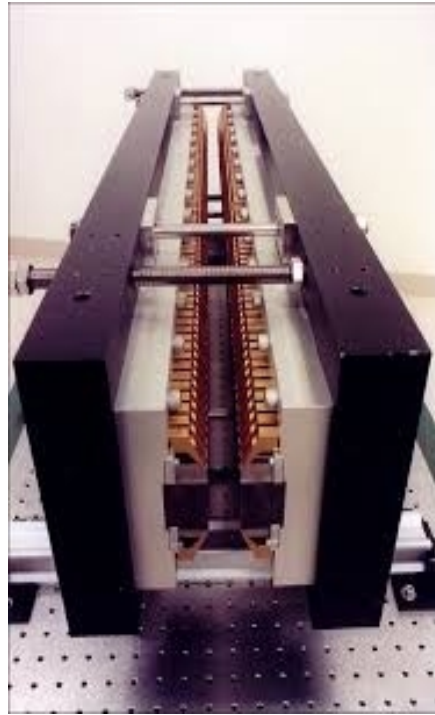
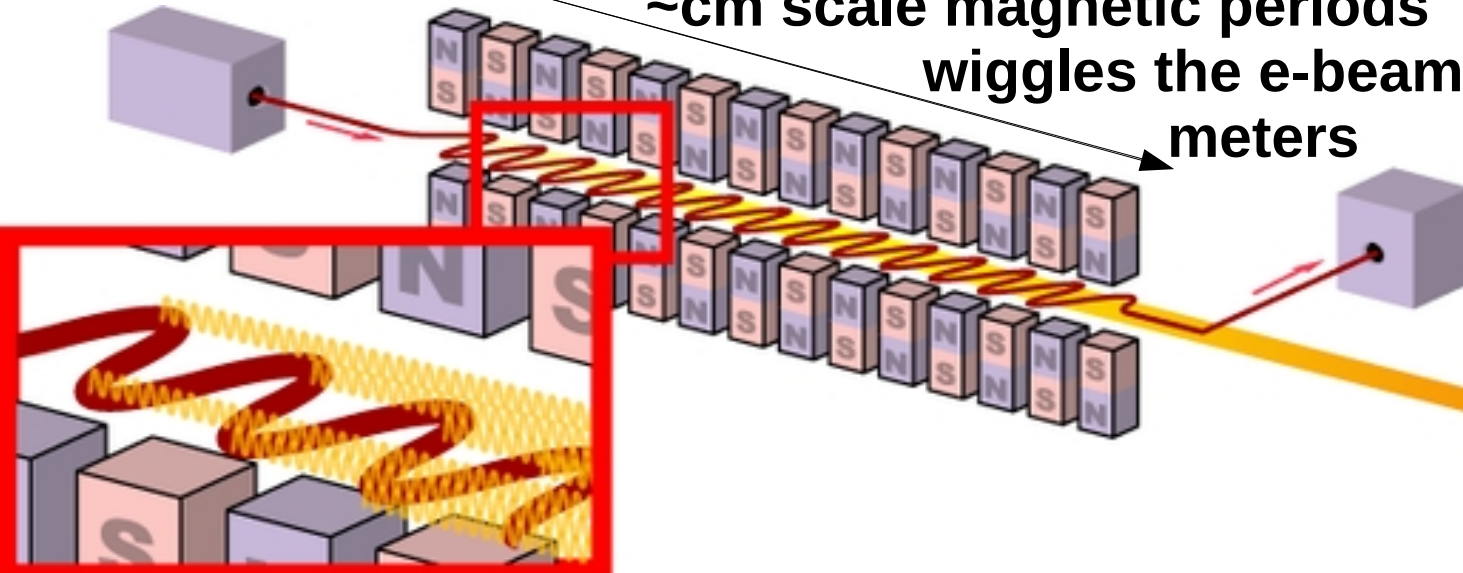

In an FEL, the undulator is embedded in a resonant cavity, just as a laser medium.

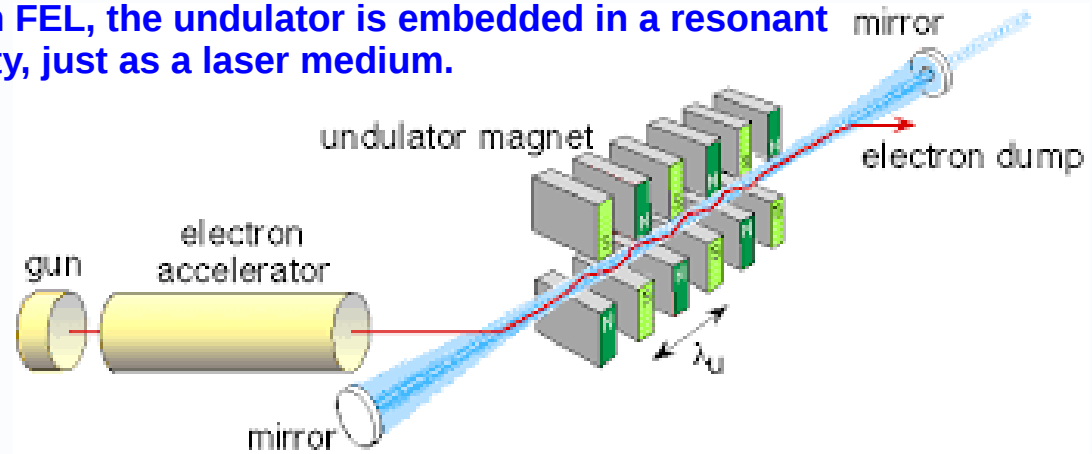

Monochromatic light spot

$$\lambda(\theta) = \lambda_u / (2\gamma^2) (1 + \gamma^2\theta^2 + K^2 / 2)$$

An FEL can be installed in
a ring, or in **a linac**.

That depends on the type of application,
on desired photon beam properties.

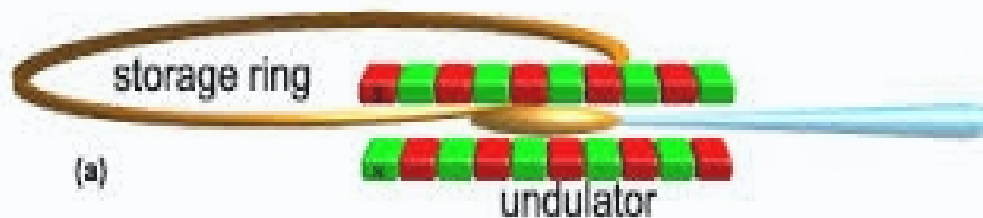

**We'll be back to ring
light sources, later in the
tour...**



Linac FEL

- Principle layout of the FEL installation

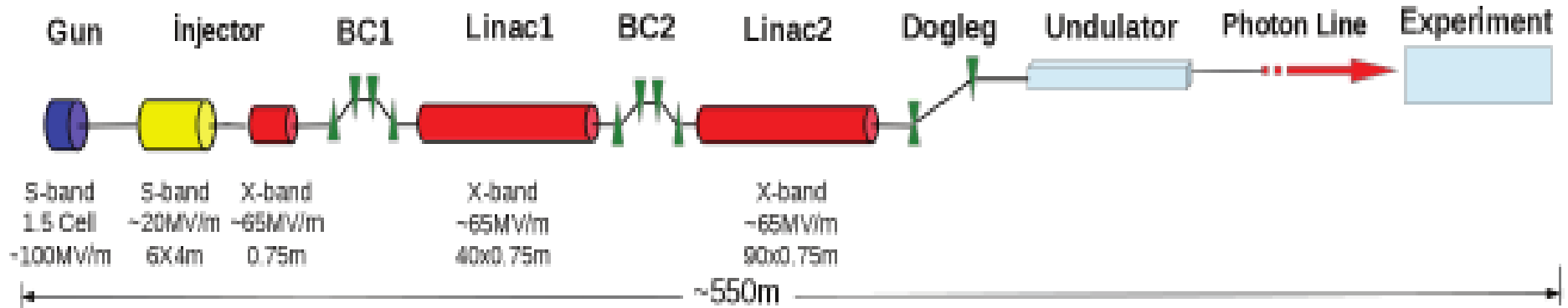

- The linac sections in that installation :

Their principles remain the same as for *proton/ion* linacs, id est,

- an accelerating gap,
- in a resonant cavity
- with some technological subtleties, proper to ultra-relativistic velocity of the electron beam



**FLASH SC linac,
at DESY, in
Hamburg, Germany.**

The linac can be a *re-circulating linac*, moreover with *energy recovery*, “*ERL*”...

Principle of an ERL

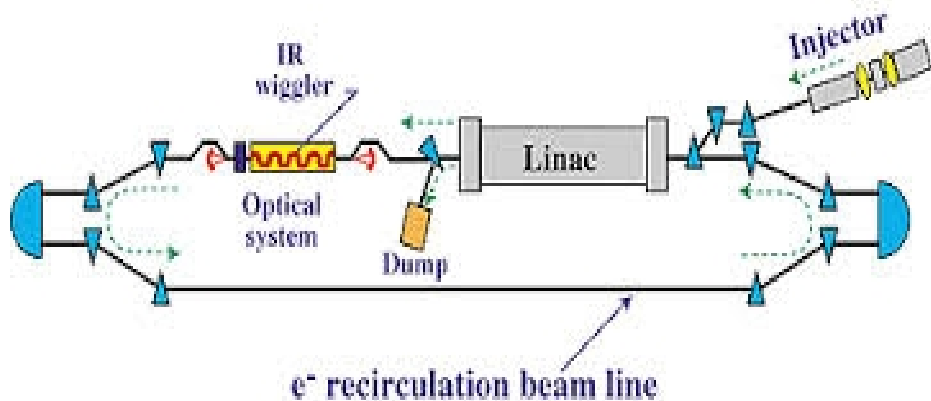

JLab ERL-FEL Specifications

| | |
|----------------------------|------------------|
| Wavelength range (IR) | 1-14 μ m |
| Energy/pulse | 120 μ J |
| Pulse repetition frequency | Up to 75 MHz |
| Pulse length | 500-1700 fs FWHM |
| Maximum average power | >10 kW |
| Wavelength range (UV/VIS) | 250-1000 nm |
| Energy/pulse | 20 μ J |
| Pulse repetition frequency | Up to 75 MHz |
| Pulse length | 300-1700 fs FWHM |
| Maximum average power | >1 kW |

Self-Amplified Spontaneous Emission “SASE-FEL”

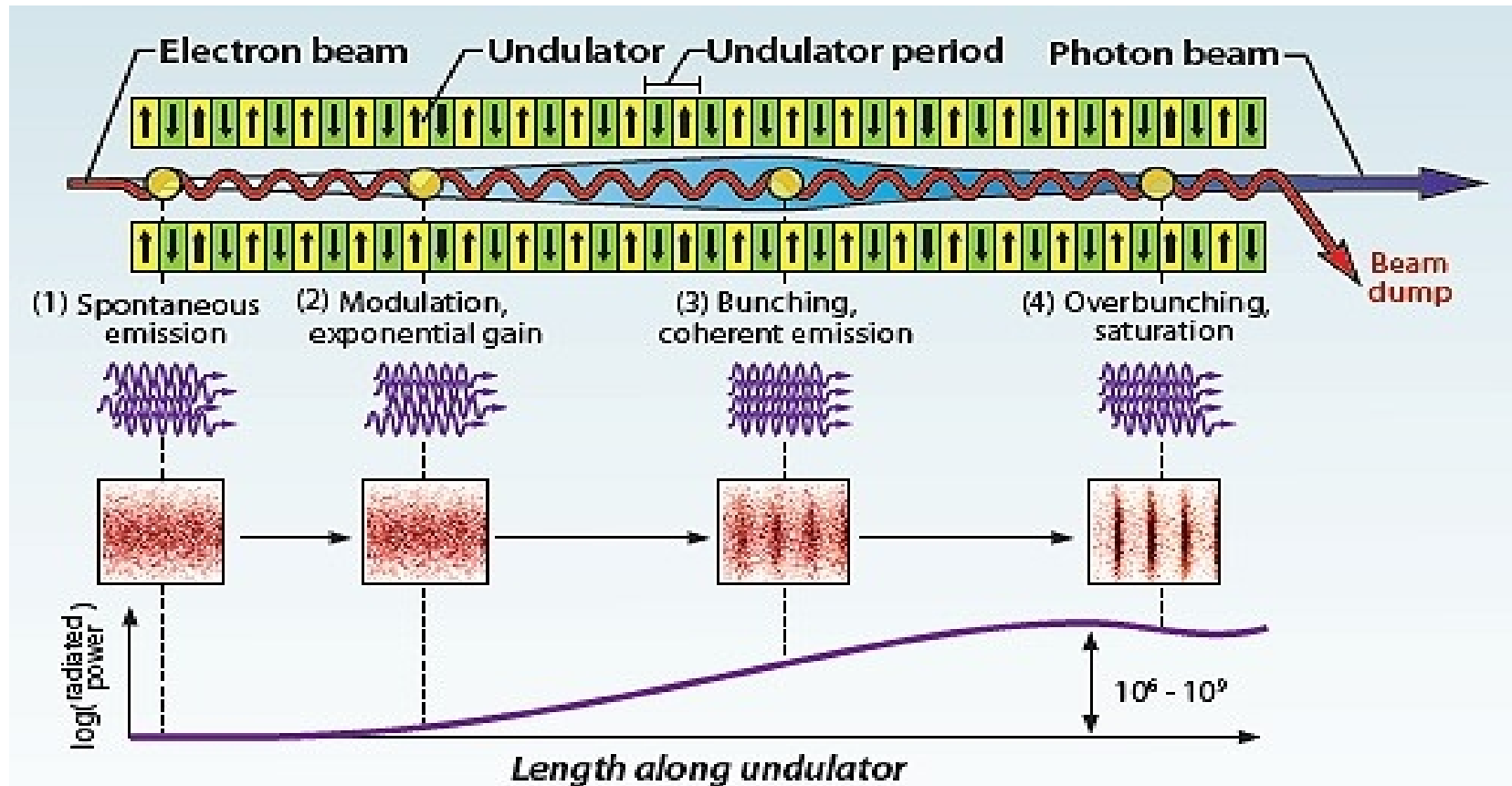

- Principle : the e-beam density modulates into short bunches, $l \sim \lambda$.
 - Thus : coherent radiation,
power $\sim (Ne)^2$ rather than (incoherent) power $\sim N e^2$,
i.e., high brightness highly collimated femtosecond X-ray pulses.
Can make life science X-movies !

FLASH SASE-FEL INSTALLATION, HAMBURG

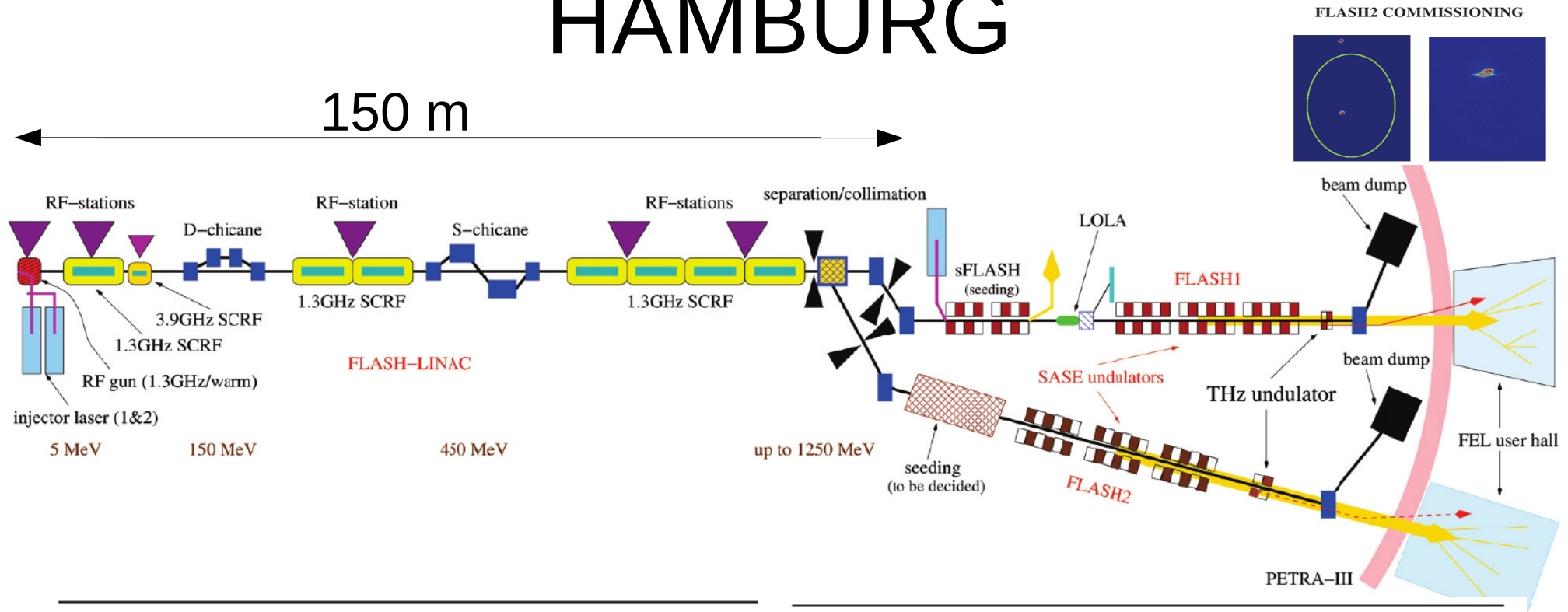

| e^- : | |
|----------------------------|-----------------------------|
| emittance | $\beta\gamma\epsilon_{x,y}$ |
| (1 nC, on-crest, 90% rms) | 1.4 mm mrad |
| charge | 0.08 - 1.0 nC |
| peak current | 0.8 - 2.0 kA |
| beam energy | 380 - 1250 MeV |
| bunches / train | 1 - 450 |
| bunch spacing | 1 - 25 μ s |
| train repetition frequency | 10 Hz |

| γ (FLASH1): | |
|--|-------------------------|
| wavelength (fundamental) | 4.2 - 45 nm |
| average single pulse energy | 10 - 540 μ J |
| pulse duration (fwhm) | <30 - 200 fs |
| spectral width (fwhm) | 0.7 - 2.0 % |
| peak power | 1 - 3 GW |
| peak brilliance | $10^{29} - 10^{31}$ (+) |
| average brilliance | $10^{17} - 10^{21}$ (+) |
| (+) : photons/(s mm ² mrad ² 0.1%bw) | |

What are the plans with this field of linac applications, what is the future ?

Cutting edge research, based on a revolutionary tool

An instance, from FEIS-2 conference web site :

- **Femtosecond Electron Imaging and Spectroscopy**
- **Structure and spectroscopy of matter with atomistic space and femtosecond time resolution, enabled by the development of extremely bright radiation sources, such as high-brightness X-ray and electron beam systems. The capabilities of generating ultrabright sources and very high level of control in delivering intense electron beams through tuning of source geometry, pulse shaping, laser-electron pulse synchronization, and understanding of space-charge effects are now synergistically enabling ultrabright electron microscopes and electron microdiffraction systems for femtosecond imaging and spectroscopy.**
- **FEIS-2 will bring together leaders engaged in cutting edge development of high-brightness electron and X-ray beam systems and their applications to frontier science problems, in order to showcase recent progress and discuss future directions and opportunities. It will also attempt to draw comparisons to other recently emerging approaches to ultrafast observation. The workshop will build on the potential synergy between related technology developments and various emerging scientific opportunities.**

CYCLOTRON

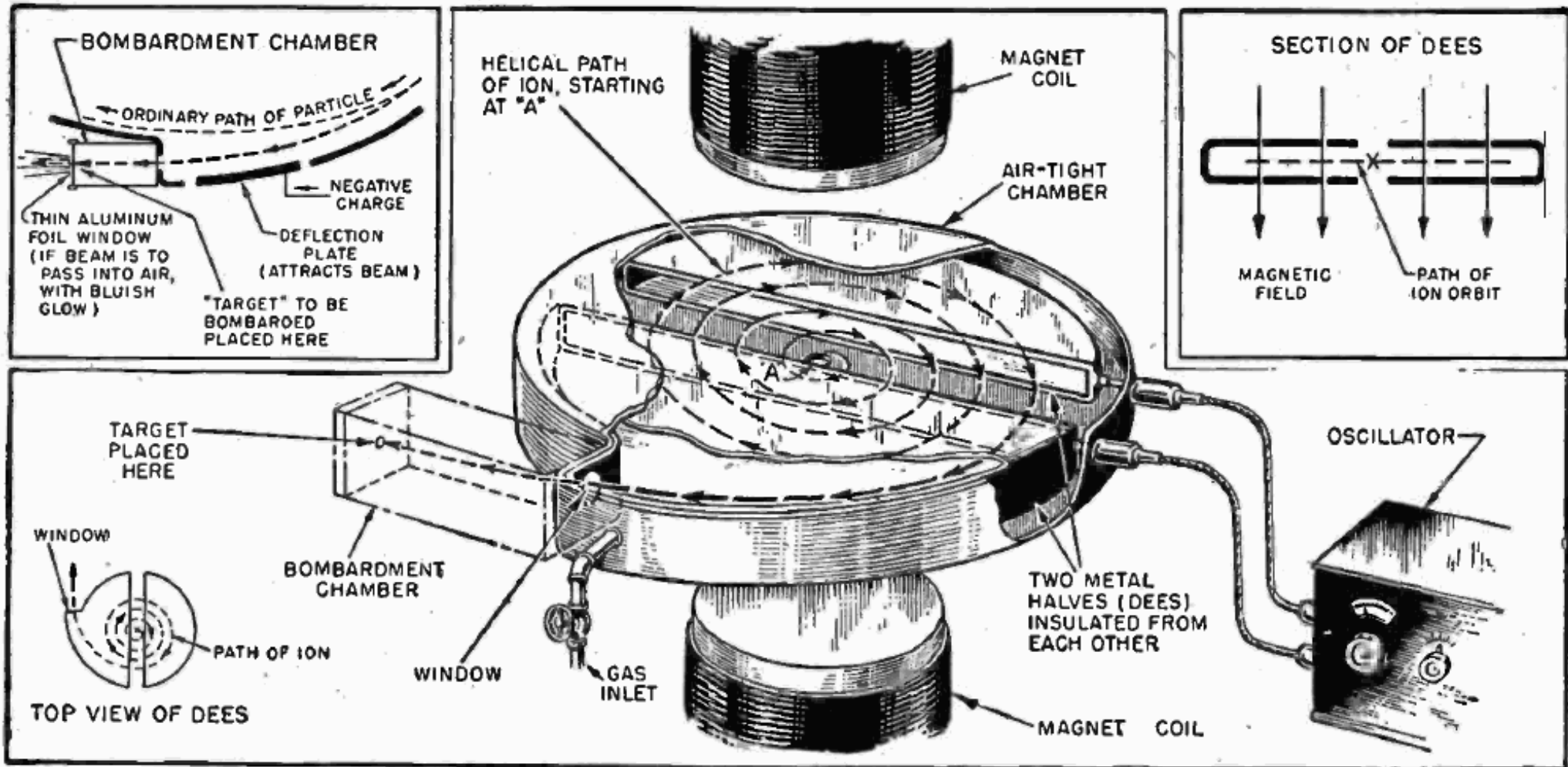

- The idea and theory of the cyclotron goes back to Max Steenbeck, PhD, Kiel, 1927. Leo Szilard patented the concept of bending+RF acceleration in 1929.

Cyclotron (1/5)

- 1929-1930, Ernest O. Lawrence inspired by Wideroe & Ising ideas invents (the principle of) the cyclotron : having read Wideroe's paper, he speculated on the use of a magnetic field to bring the particle back to a *single* accelerating gap next to acceleration.

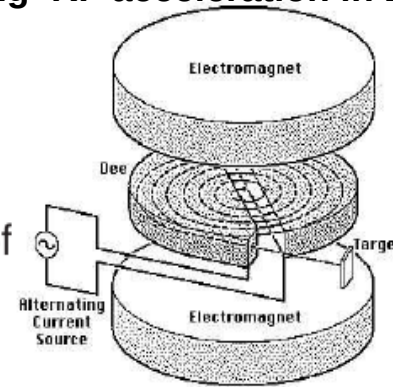

- Doing so he found that the revolution frequency in uniform B is constant : the “cyclotron angular frequency”, $\omega_0 = qB/m$
- That allows RF gap voltage at constant frequency, $f_{RF} = qB / 2\pi m$.

- 1931, Stanley Livingston, Berkeley, demonstration with 5-inch cyclotron by acceleration of hydrogen ions up to 80 KeV (about 40 turns up to $r \approx 4.5$ cm).
- 1932, $\phi 30$ cm cyclotron built by Lawrence produces protons at 1.25 MeV and breaks atoms *a few weeks after Cockcroft-Walton's Li + p*
- 1934, Berkeley, E.O. Lawrence builds a 27-inch cyclotron, accelerates protons to 3 MeV and D to 5 MeV
- 1939, E. O. Lawrence receives the Nobel Prize “for the invention and development of the cyclotron and for results obtained with it, especially with regard to artificial radioactive elements”.

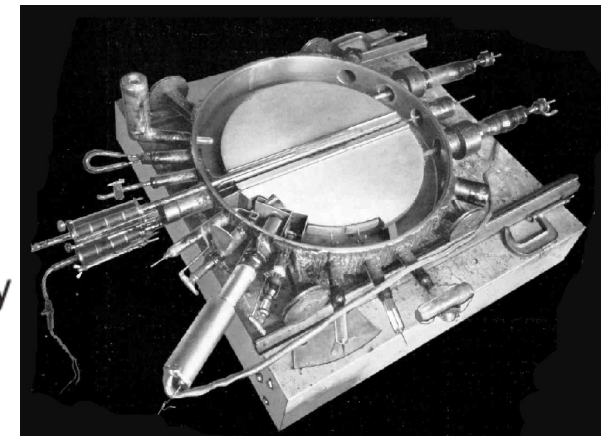
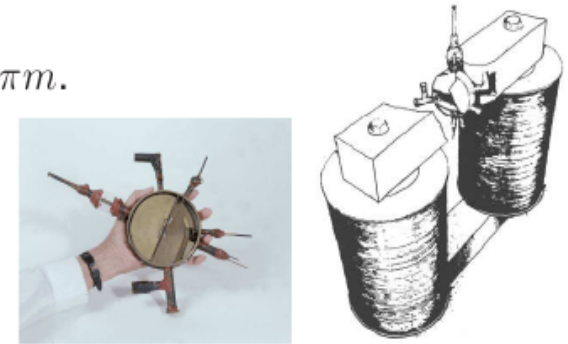

The device is inserted in the gap of an electromagnet.

- That was just the beginning of a lasting story, yet...

Ref.:
[wikipedia](#)

- E.O.Lawrence 27 inch cyclotron, 1932.
- The ensemble on the photo is plunged in the gap of an electromagnet
- 13,000 V RF accelerating potential at about 27 MHz is applied to the dees by the two feedlines visible at top right.
- Beam emerges from the dees and strikes the target in the chamber at bottom.

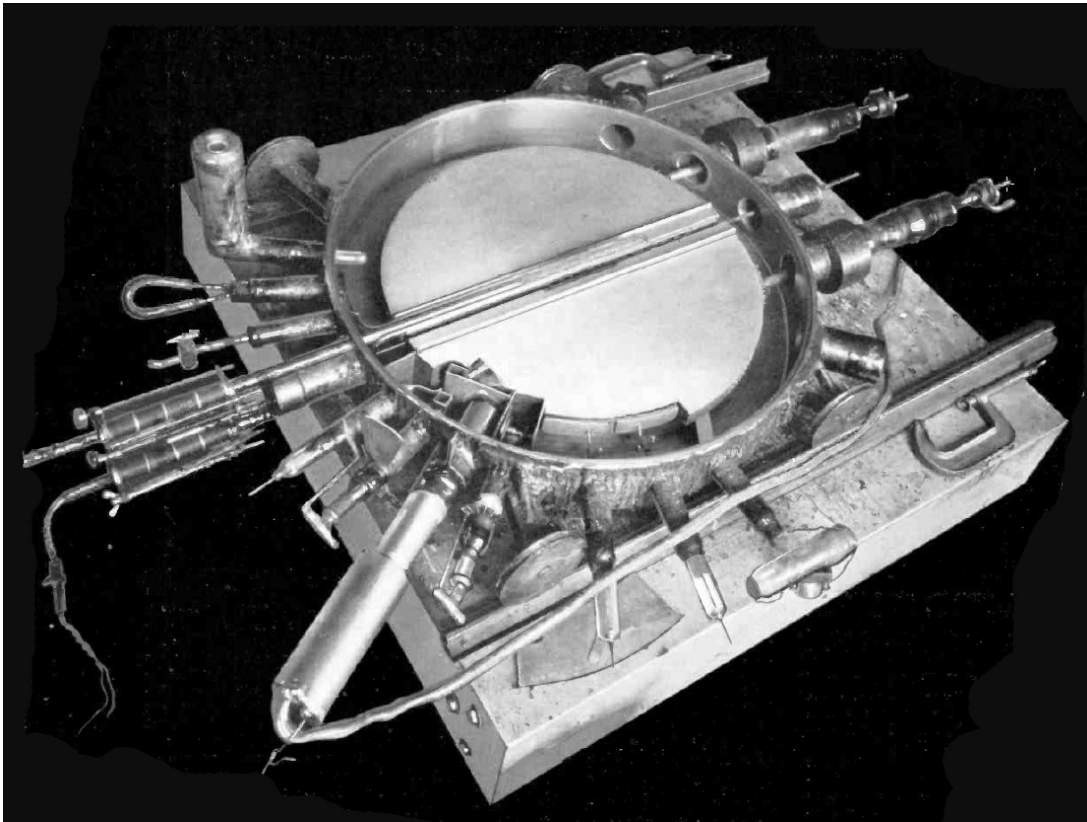

- 60-inch cyclotron, ~1939
- Exiting beam of accelerated ions ionize the air.

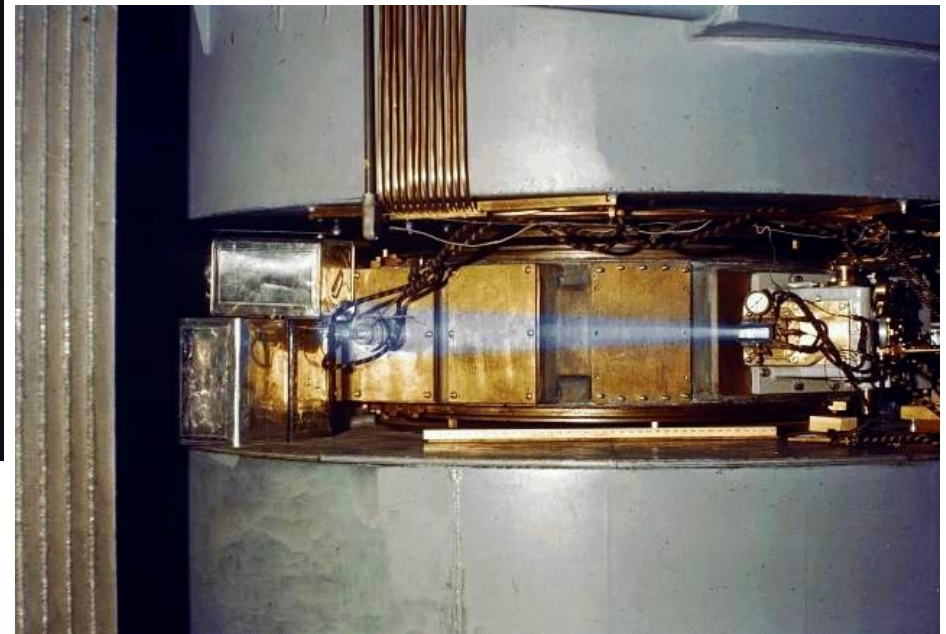

Cyclotron (4/5) - Thomas focusing

- 1938, L.H. Thomas, “The Paths of Ions in the Cyclotron”, introduces the “Thomas focusing”, based on separate sector bending, namely, “edge-focusing”,
- 1954, Kerst, spiral edges increase vertical focusing further

$$\nu_z = \sqrt{-k + F^2(1 + 2 \tan^2 \xi)}, \quad F = \text{Flutter} = \frac{\langle B^2 \rangle - \langle B \rangle^2}{\langle B \rangle^2}$$
- That allowed having $B(r)$ increase in proportion to γ , so to ensure constant RF frequency ($\omega_0 = qB/\gamma m$), while *preserving vertical focusing*.
- Modern cyclotrons still rely on these principles

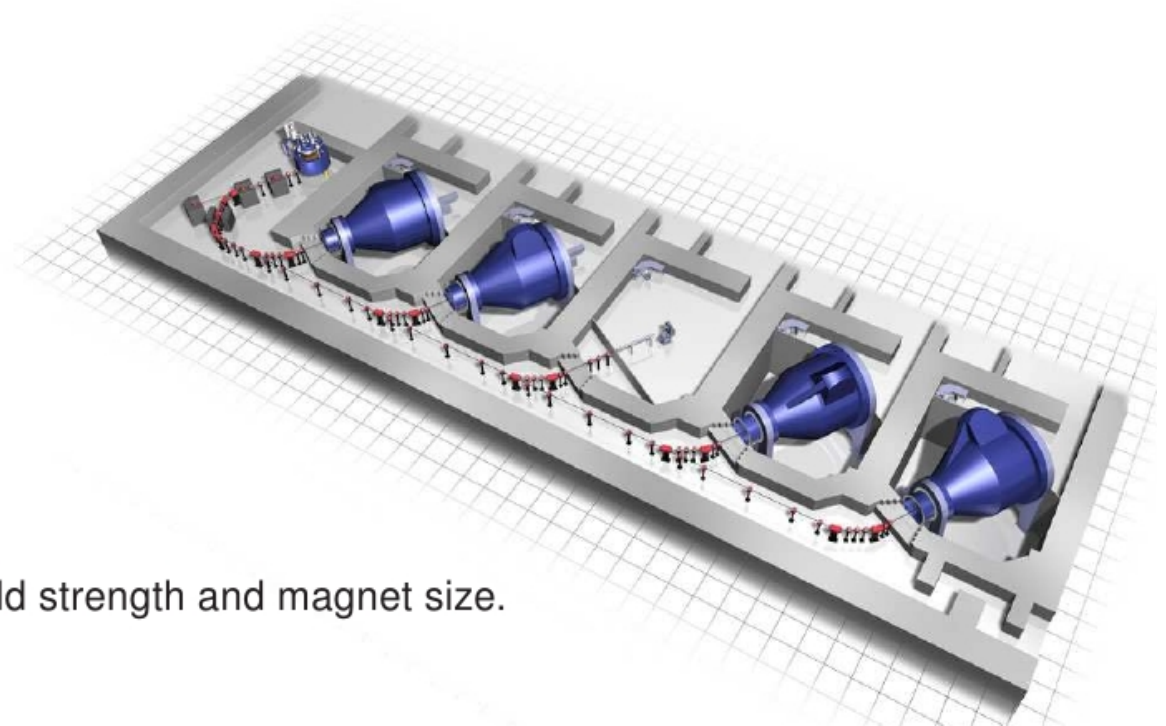
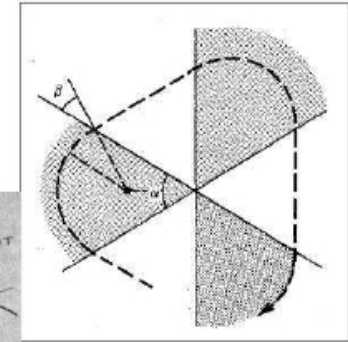
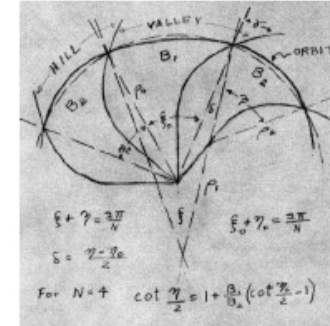

- Cyclotron is limited in energy by its field strength and magnet size.

ION BEAMS FOR HADRON-THERAPY

AKA,

***3-D CONFORMAL
RADIATION-THERAPY***



Proton-therapy is a predilection domain for the cyclotron

- synchro-cyclotron might take over :
IBA's S2C2
 - in some treatment centers a
synchrotron

(carbon-therapy : synchrotron)

Advantages of the bragg-peak ballistic: 3D conformal irradiation

- Better sparing of healthy tissues
- competitive with IMRT

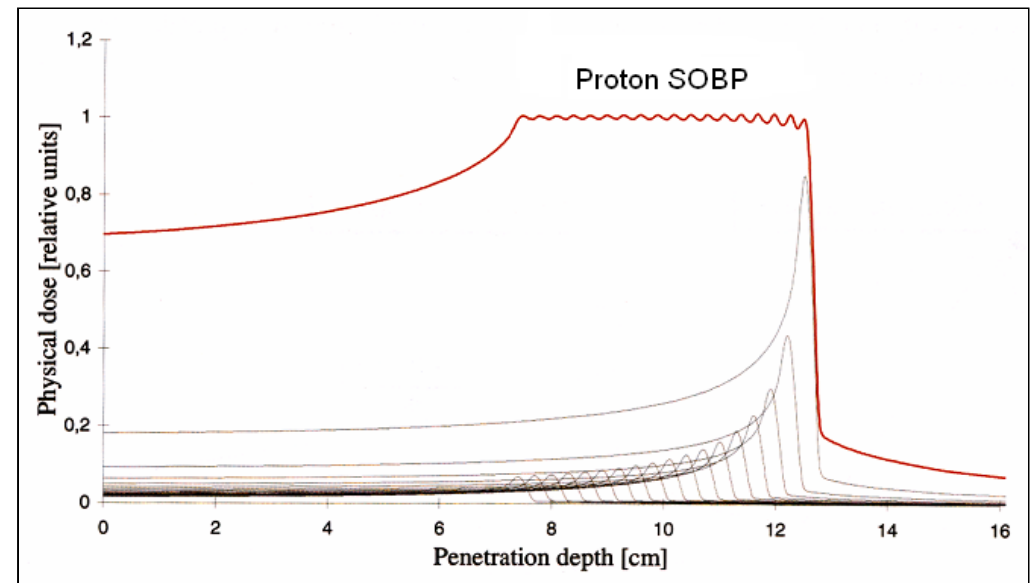
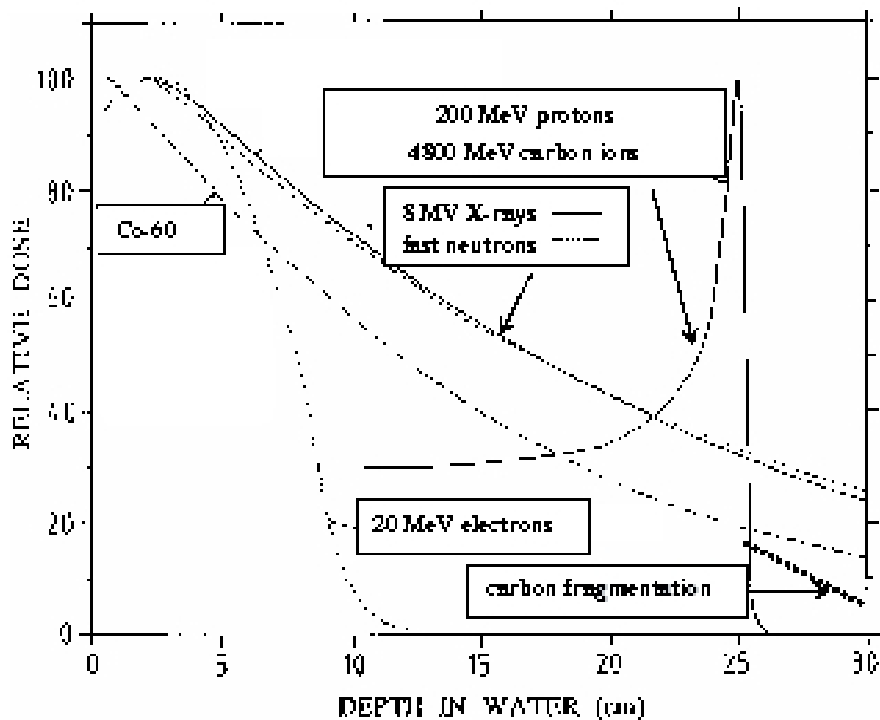
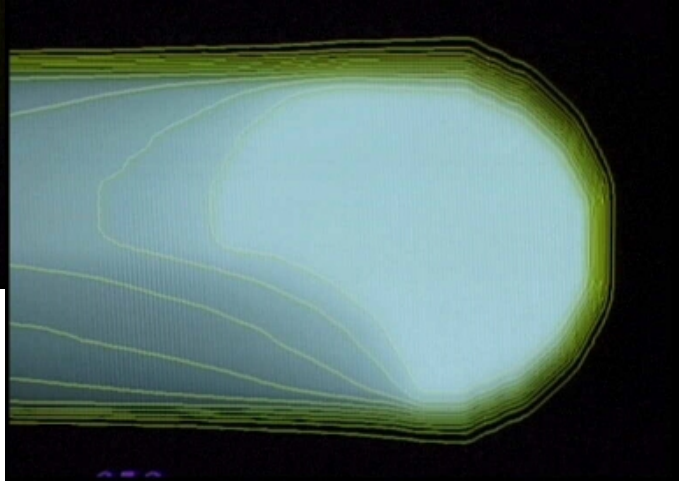
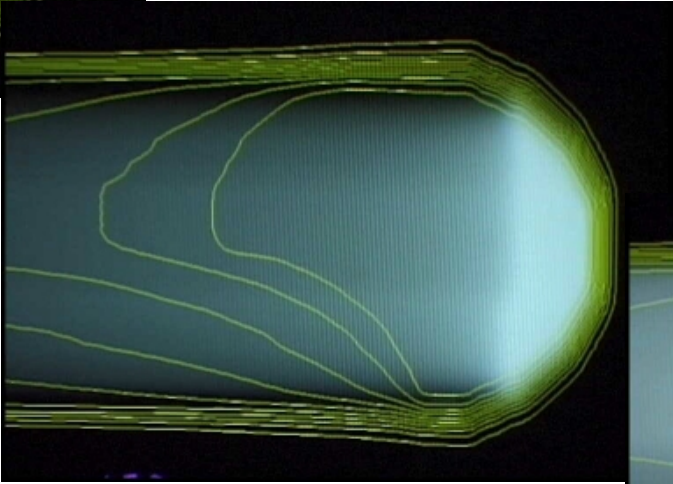
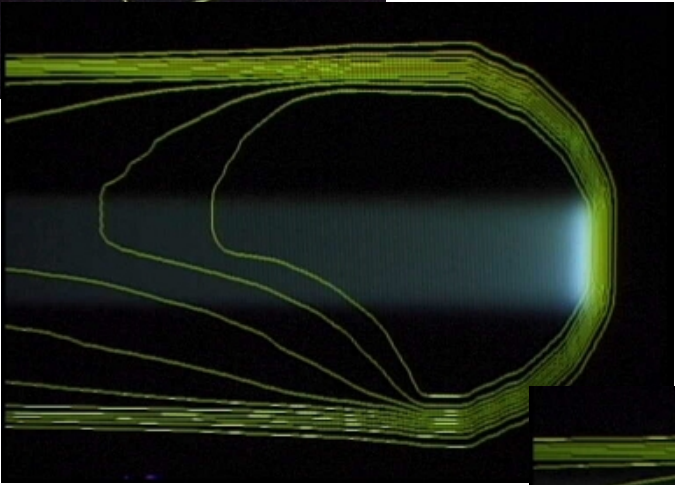
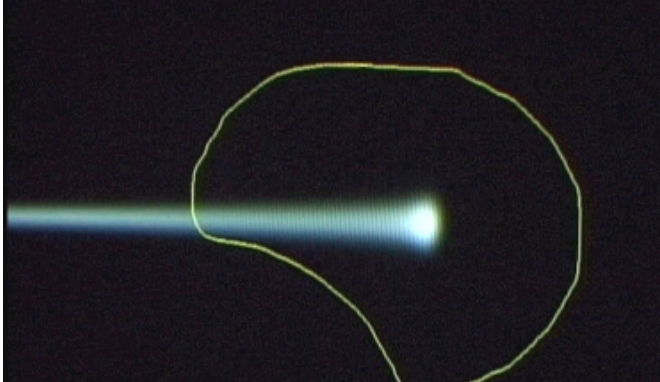
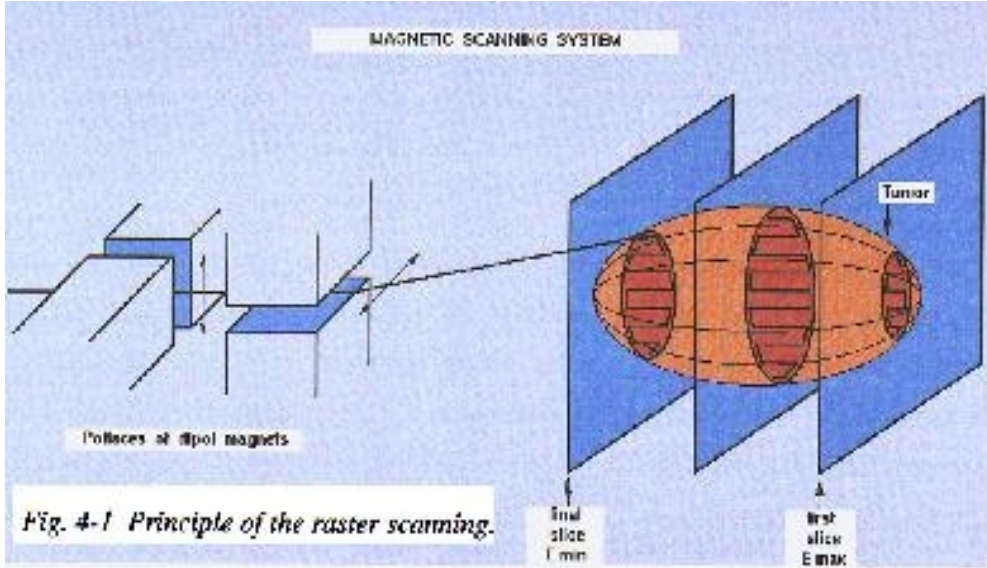

Figure 1. Depth dependence of the deposited dose for different radiations. Because of the Bragg peak it is said that the dose distribution is 'inverted' with respect to the almost exponential, and much less favourable, behaviour produced by a beam of high-energy photons.

Active scanning



On the other hand

- An hadron (proton, carbon) accelerator is a big investment, e.g., of the order of EU150M for a turn-key carbon-therapy hospital,
- High cost of a session : of the order of EU600 per session, ~3x cost of an IMRT session.
~EU20k per treatment

so, alternate technologies are sought... this is not the end of the story !

HIGH POWER PROTON ACCELERATORS

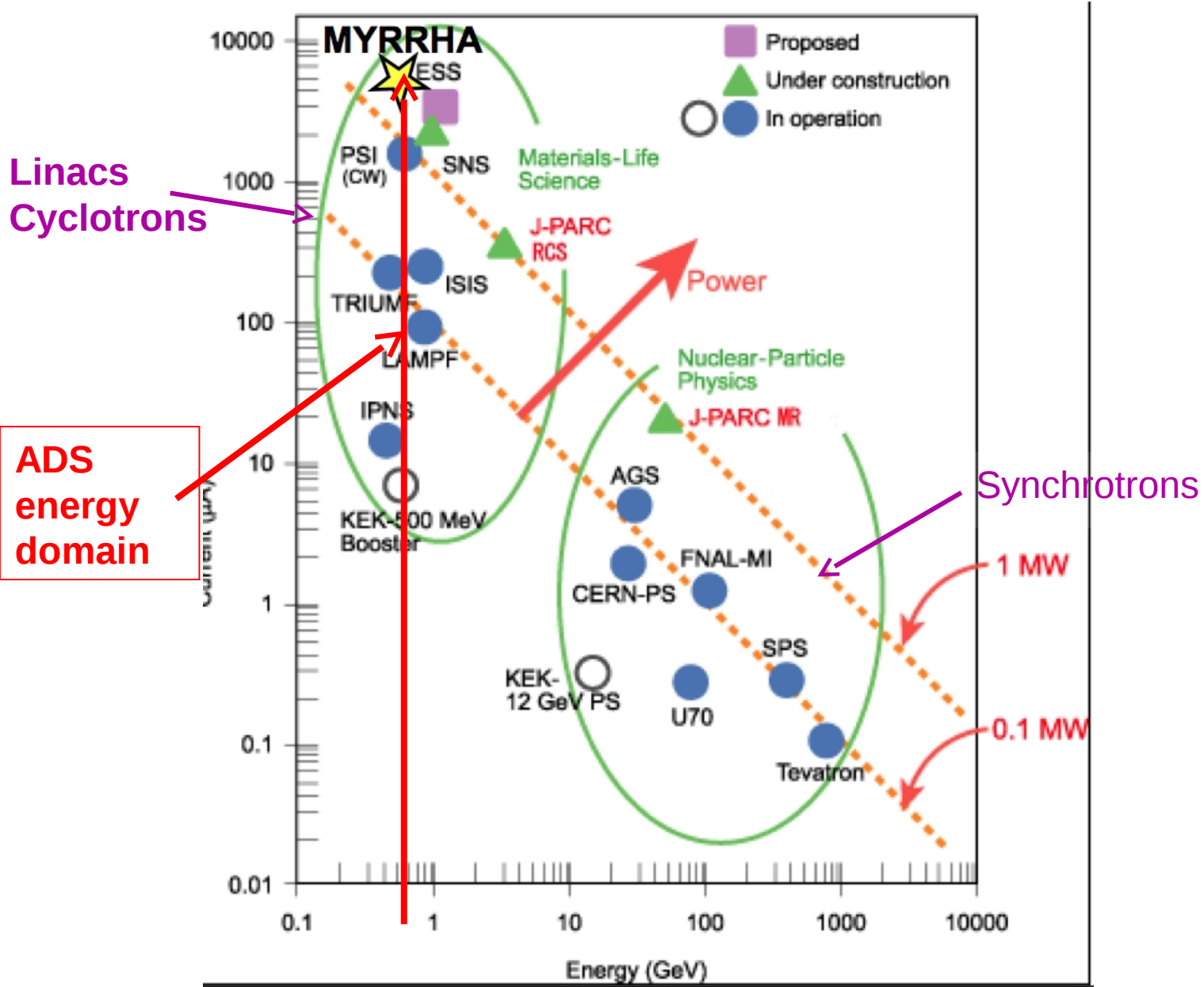

*** Let's consider neutron production *
HIGH POWER:
this is where we are today,
PSI, 590 MeV, 1.2 MW, CW**

1973

- 1 Hans Willax
- 2 Miguel Olivo
- 3 Thomas Stammbach
- 4 Werner Joho
- 5 Christa Markovits



1966: SIN early Design – Feb. 1974:1st 100 μA beam

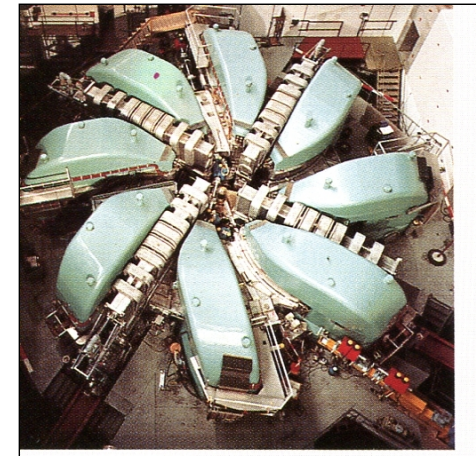
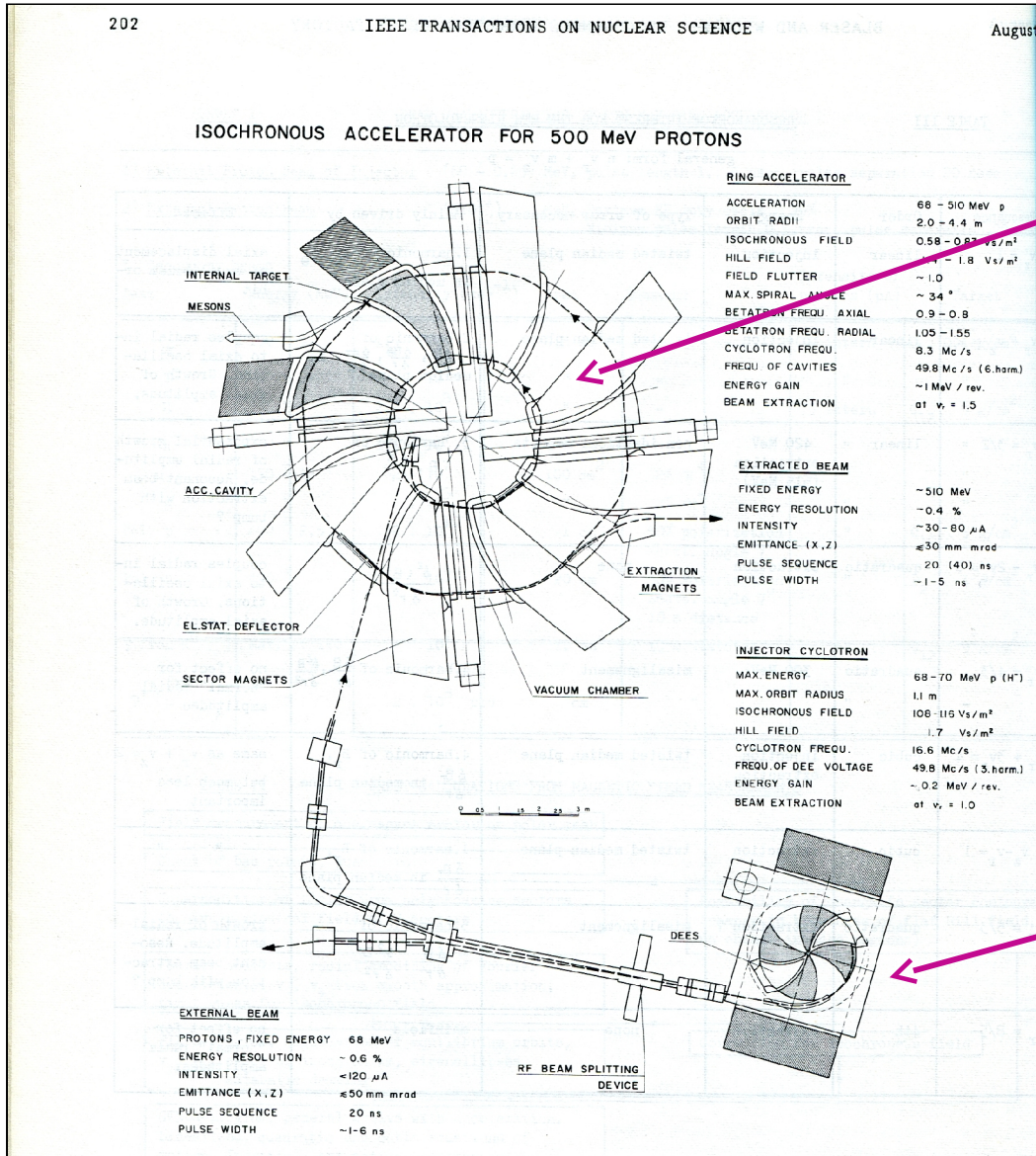

The 590 MeV Ring Cyclotron

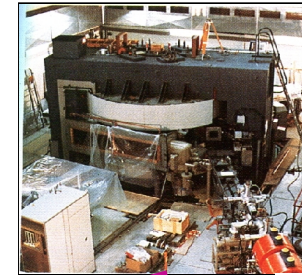

The old 72 MeV Philips injector

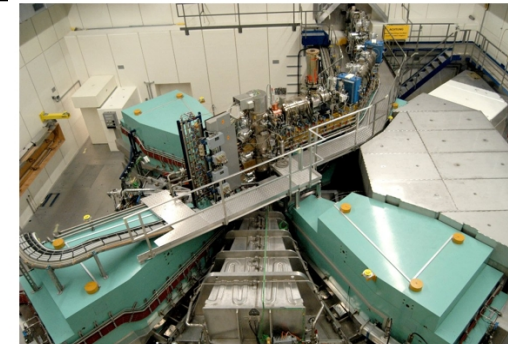

Nowaday's 72 MeV injector

Injector 2 Cyclotron for 72 MeV proton beams.

Towards Higher intensities: Today 30 times more Intensity

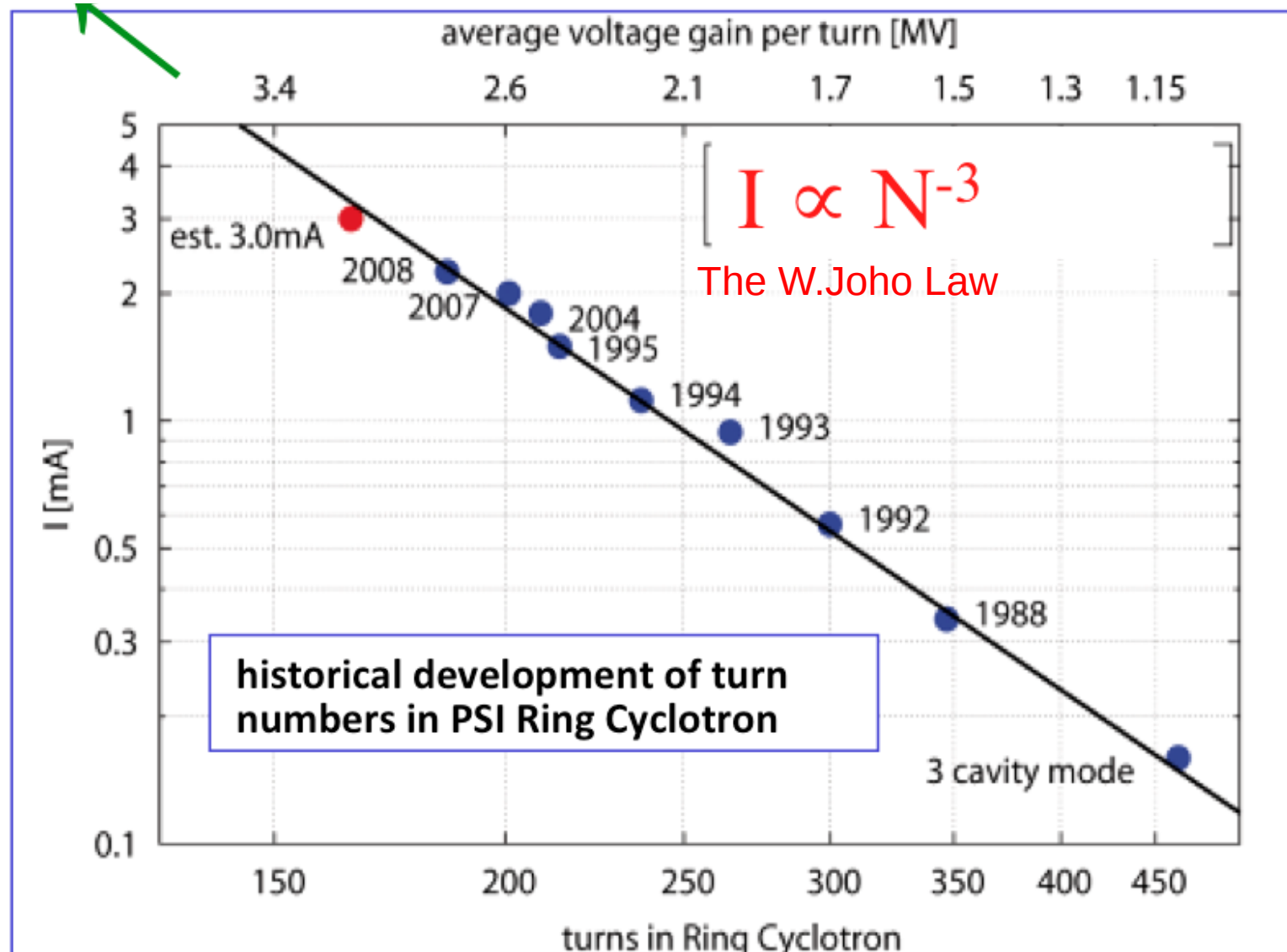

SINQ @ PSI

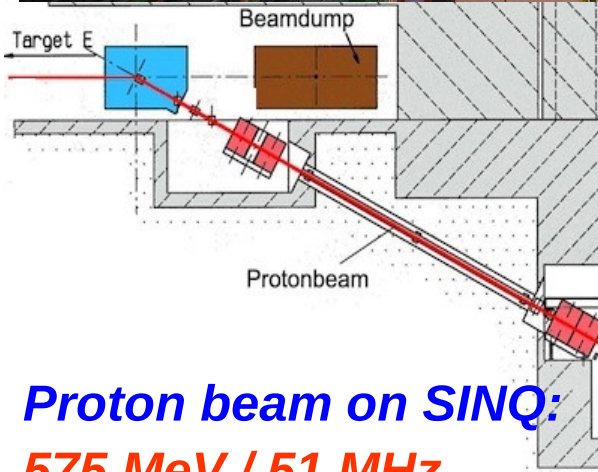
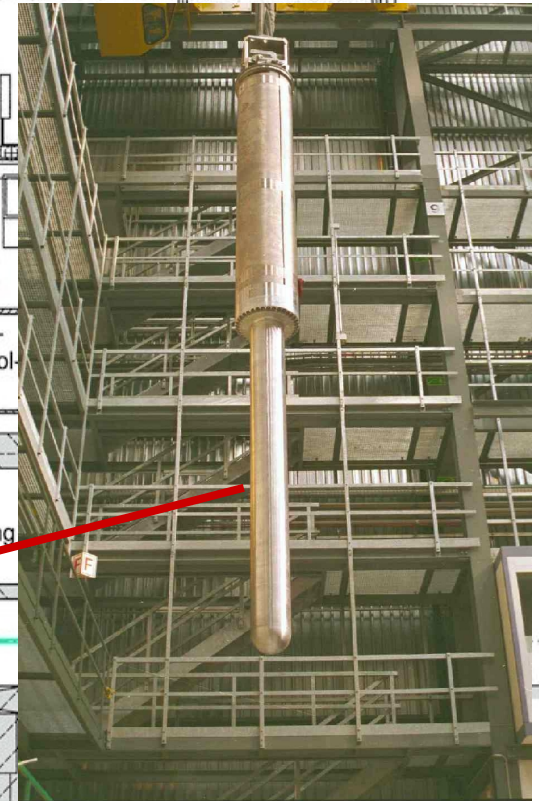
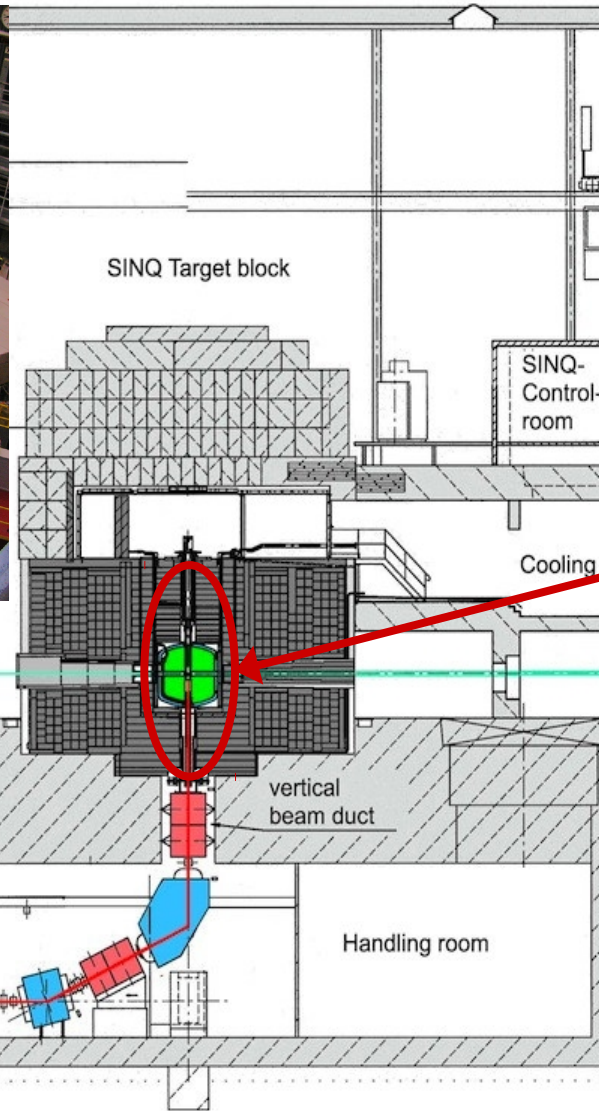
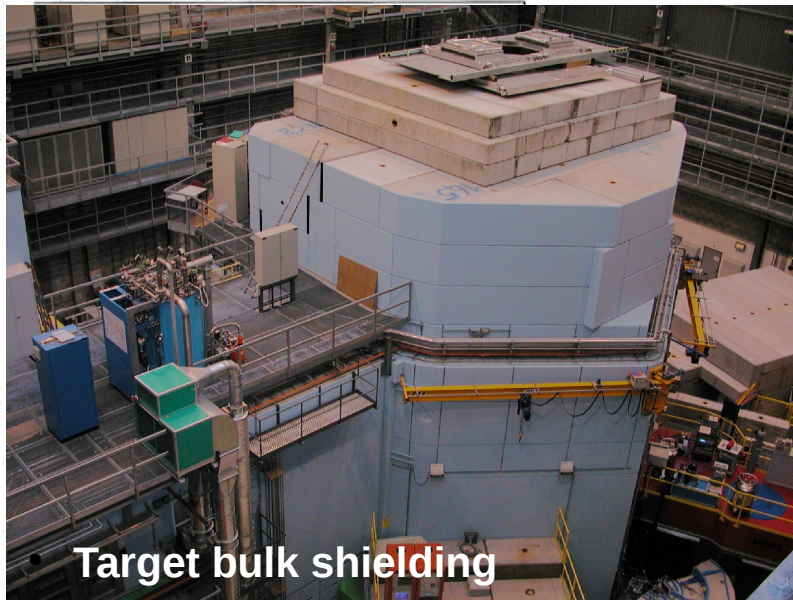

Proton beam on SINQ:
575 MeV / 51 MHz
p-Current: 1.5 / 1.6 mA
Power: 0.8 - 0.9 MW

**Total Power Deposition
in Target Assembly
~ 575 – 610 kW**

* ACCELERATOR-DRIVEN SUBCRITICAL REACTOR *

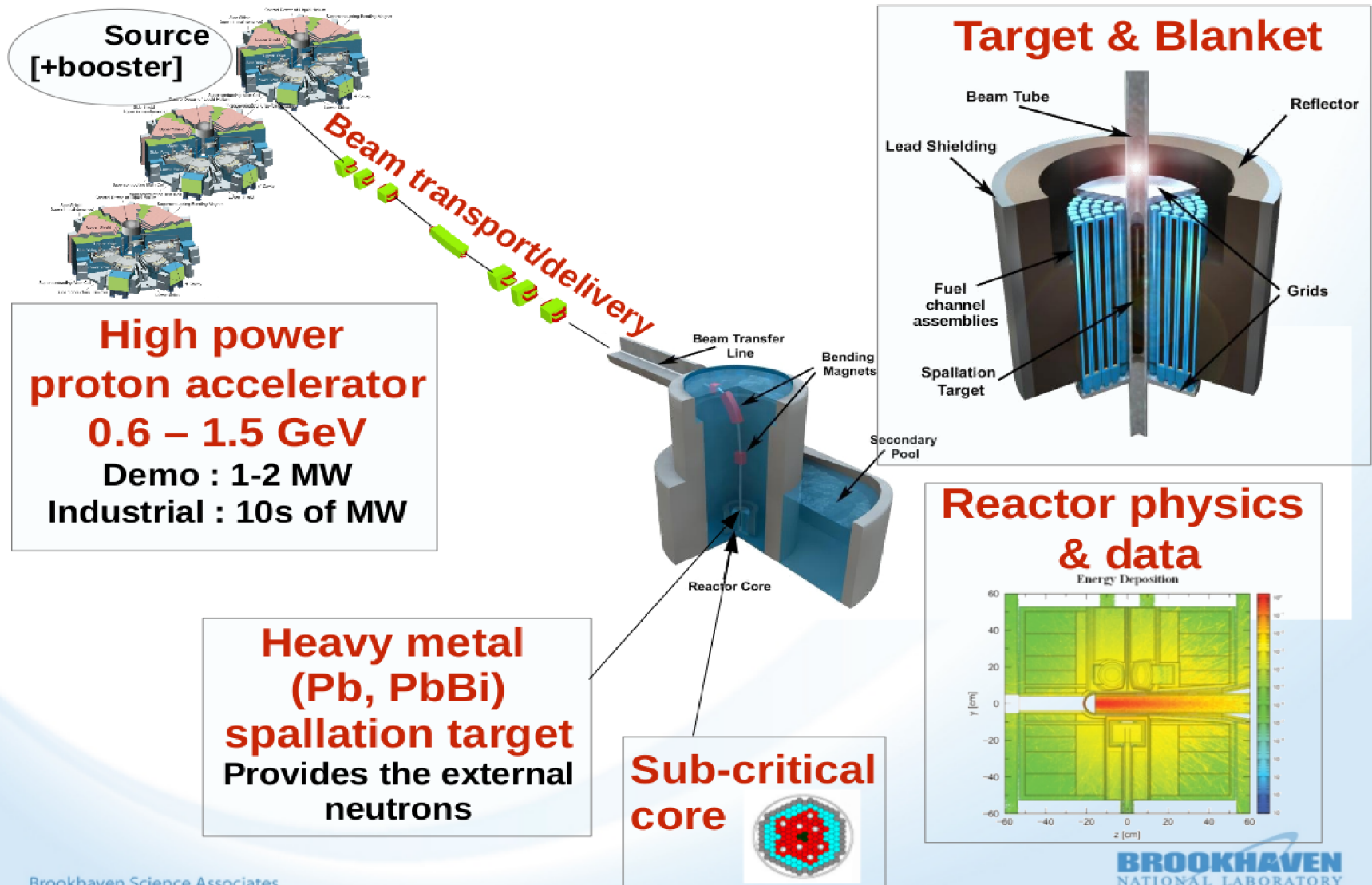

Big discussion on-going ! which technology is optimal for ADS-R application?

Reference : US ADS White Paper (2010)

- Separate sector cyclotron

Paul Scherrer Institute,
590 MeV, 1.3 MW CW beam
First beam 1973



- Normal conducting proton linear accelerator

LANSCE 800 MeV n science center linac, first beam 1972.
Ran in 1 mA / MW range in the 1980s,
120 Hz repetition rate, DC 7.5%.

- Superconducting linear accelerator

SNS 1 GeV n science linac at ORNL,
beam power 1.2~1.4 MW.
Pulsed, DC ~6%. Accelerates H- for
stripping injection into accumulator ring,
First beam 2006

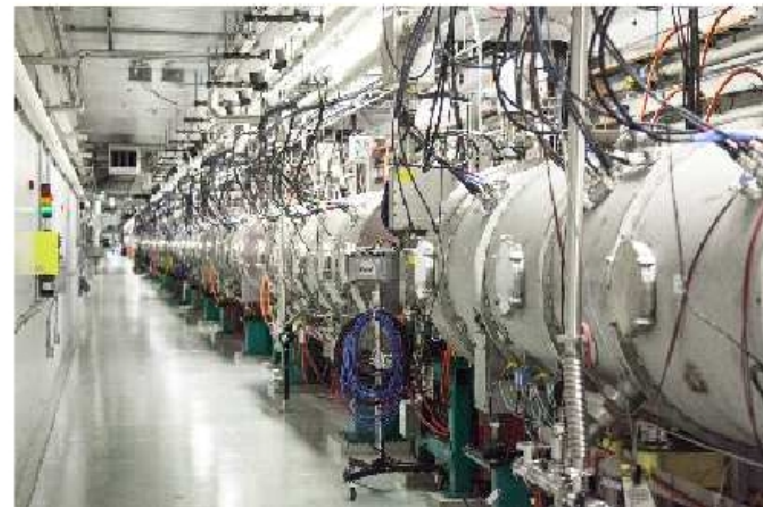

SYNCHRO-CYCLOTRON

Synchrocyclotron, from McMillan's patent.

- The oscillating electric potential varying periodically is applied to the (unique) dee.
- The acceleration of the ions takes place twice per turn.
- At the outer edge, an electrostatic deflector extracts the ion beam.
- The first synchrocyclotron produced 195 MeV deuterons and 390 MeV α -particles.

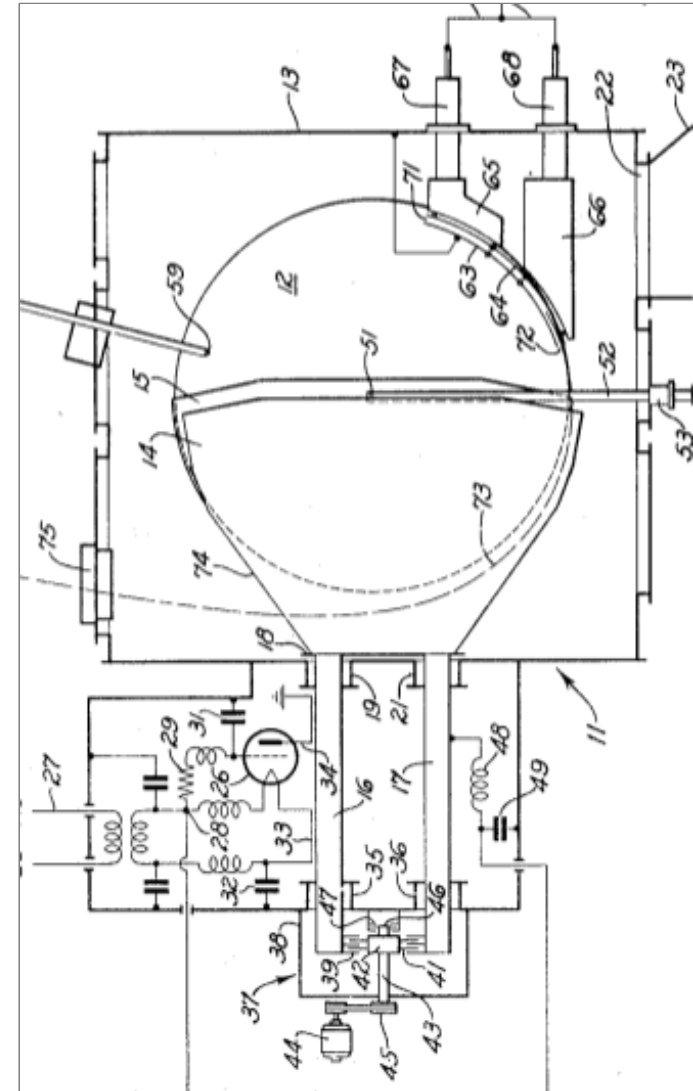

Orsay 1 kHz synchrocyclotron

Mid. 1950s: a typical nuclear physics research installation

- 1958: first beam from the 157 MeV synchro-cyclotron
- 1975: shut-down for evolution to 200 MeV synchro-cylco
- 1993: installation converted to a hadrontherapy hospital, “IC-CPO” : Institut Curie-Centre de Protontherapie d'Orsay, one of the two in France
- 2010: synchro-cyclo stopped, proton-therapy persued with an IBA C250 cyclotron

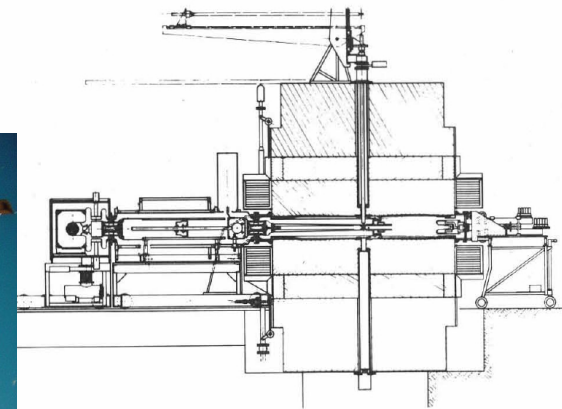
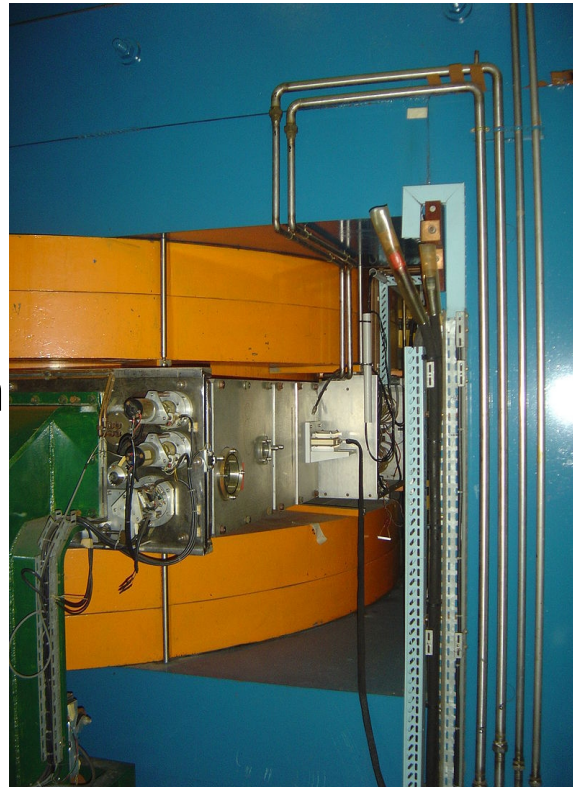

Fig.7. Side view

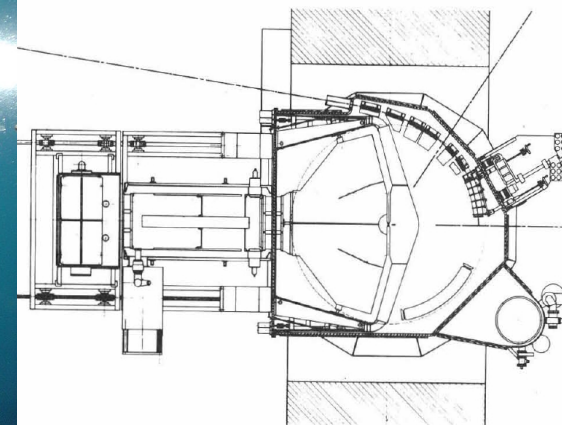
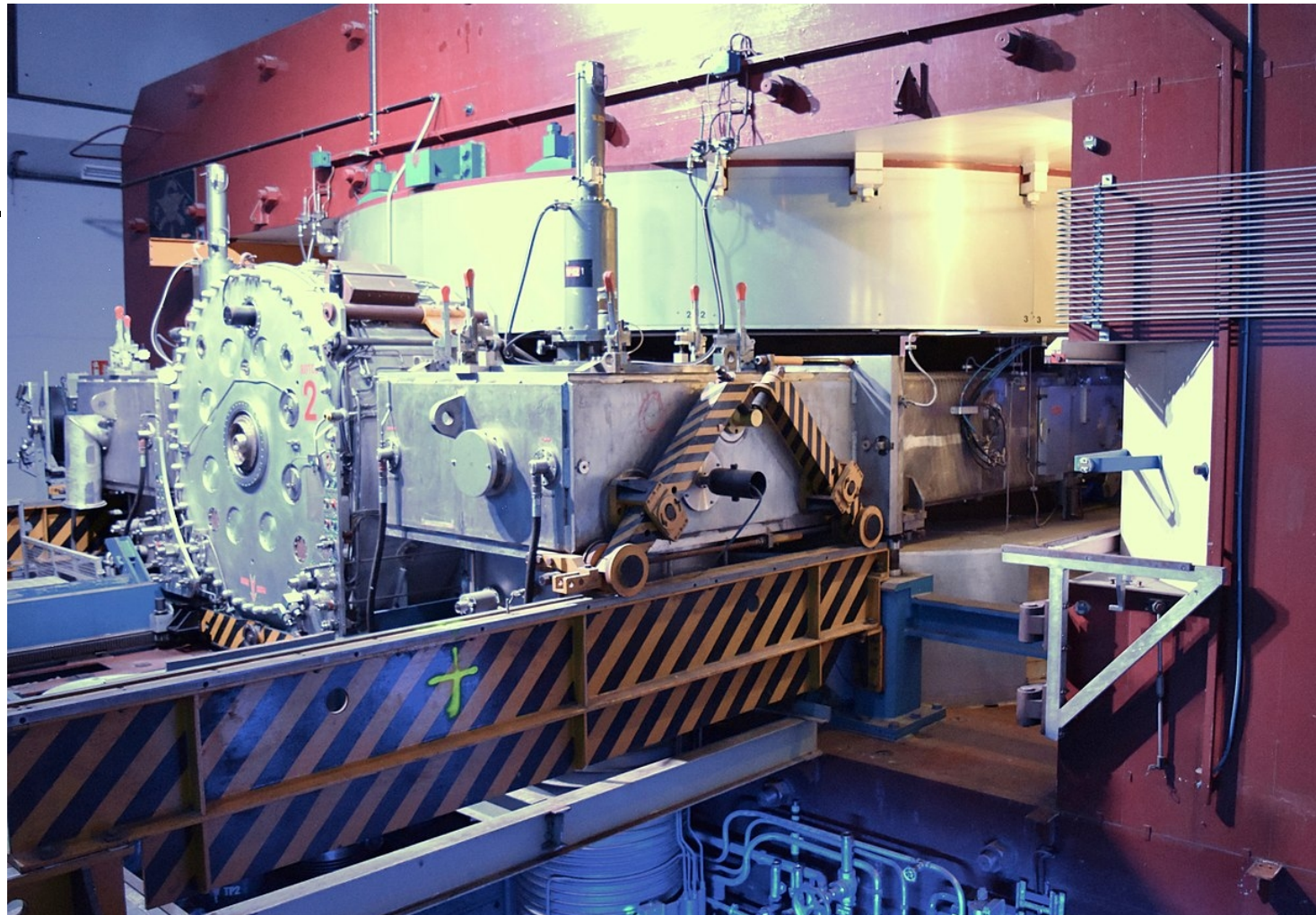
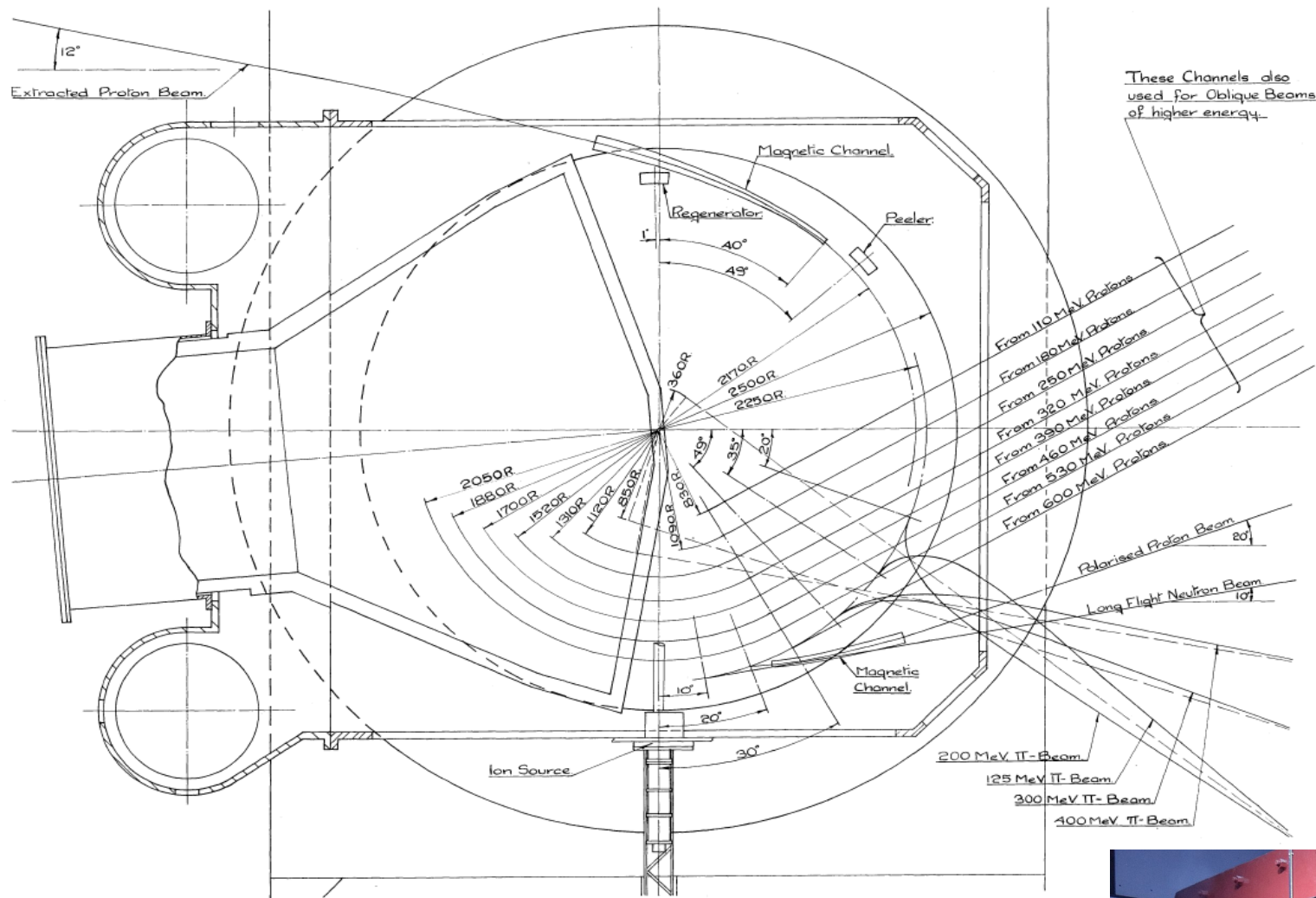

Fig.8. Top view

CERN Synchrocyclotron (SC)

- **1957: construction.**
CERN's first accelerator, provided beams for CERN's first experiments in particle and nuclear physics, up to 600 MeV.
- **1964: started to concentrate on nuclear physics, leaving particle physics to the newer, 30 GeV, Proton Synchrotron (PS).**
- **1967: start supplying beams for the radioactive-ion-beam facility ISOLDE (nuclear physics, astrophysics, medical physics.)**
- **1990: SC closed, after 33 years of service.**





A. Arrangement of internal targets, beam extraction system and ion source.

10. Parameters of the Synchro-cyclotron

| | |
|--|--------------------------|
| Maximum energy of the protons | 600 MeV |
| Expected internal circulating beam (average in time) | 1 μ A |
| Exit radius (n = 0.2) | 2.27 m |
| Flux density, at centre | 1.88 Wb/m ² |
| Flux density, at n = 0.2 (R = 2.27 m) | 1.79 Wb/m ² |
| Ampere-turns, normal | 1.2 10^6 At |
| Ampere-turns, maximum | 1.35 10^6 At |
| Coil power, normal | 750 kW |
| Magnet weight | 2500 T |
| Frequency range, theoretical | 28.7 - 16.6 MHz |
| Repetition Frequency | 55 Hz |
| Pressure in vacuum tank, ultimate | 3.10 ⁻⁶ mm Hg |
| Pressure in vacuum tank, normal | 6.10 ⁻⁶ mm Hg |

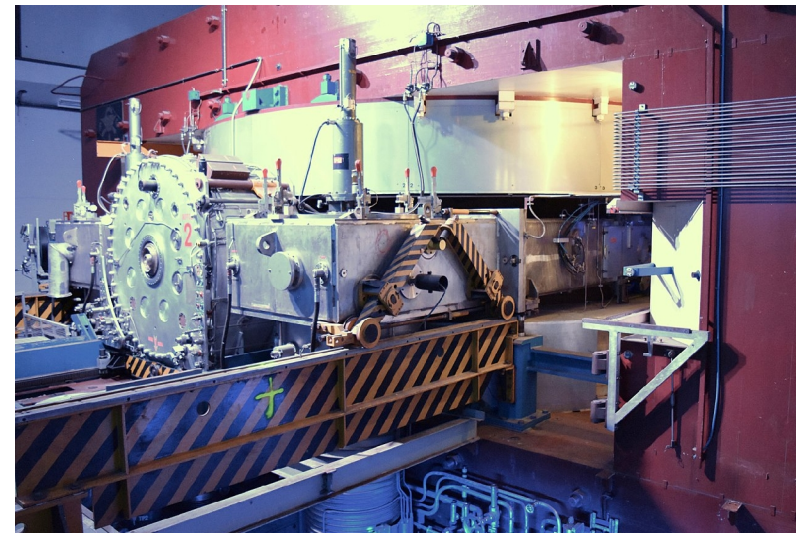

MEDICYC's S2C2

- 250 MeV protontherapy synchrocyclotron at Nice, France

- First beam 2015

- Developed by IBA and AIMA first implemented at the anti-cancer protontherapy center MEDICYC, Nice.

- compact gantry, attached to the S2C2

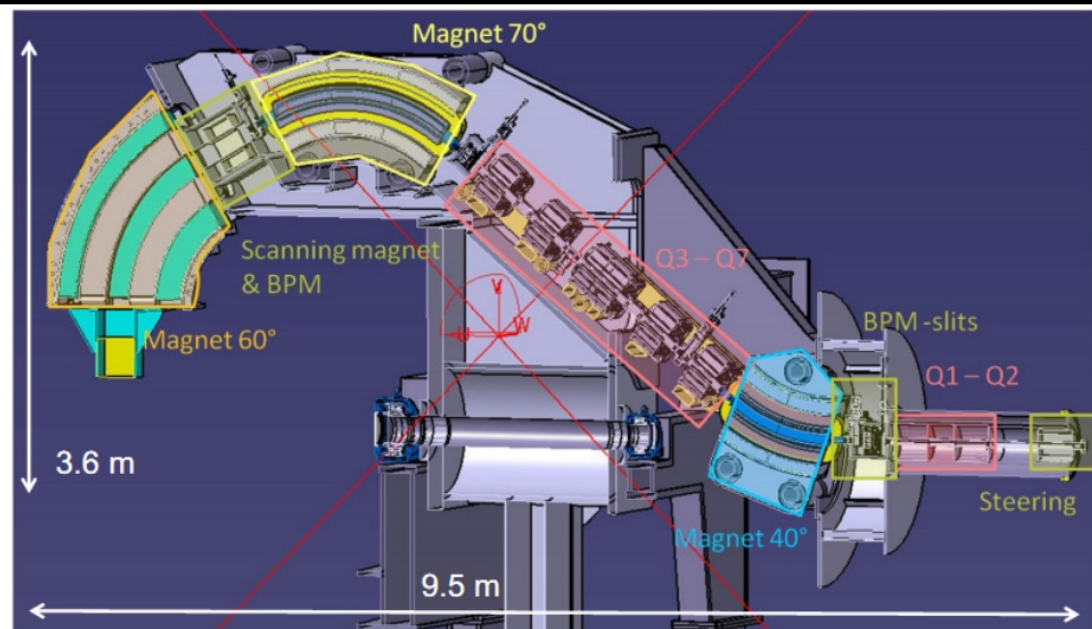

BETATRON

First successful functioning by Kerst, university of Illinois, 1940

"The acceleration by magnetic induction"
Phys. Rev., 60, 47-53 (1941)

[Reprinted from RADIOLOGY, Vol. 40, No. 2, Pages 115-119, February, 1943.]
Copyrighted 1943 by the Radiological Society of North America, Incorporated

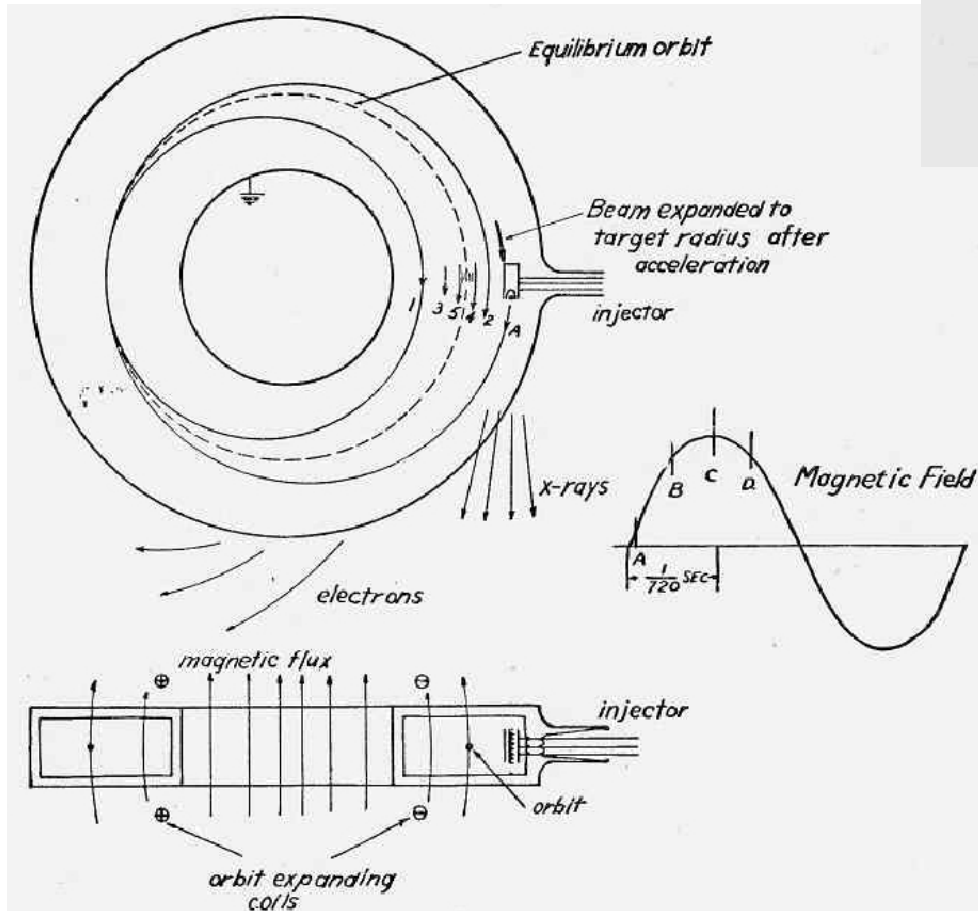

Fig. 1. The doughnut-shaped vacuum tube. Electrons are injected at time A in the magnetic cycle and directed against the target by the orbit expanding coils at time C.

The Betatron¹

D. W. KERST, Ph.D.

University of Illinois, Physics Department

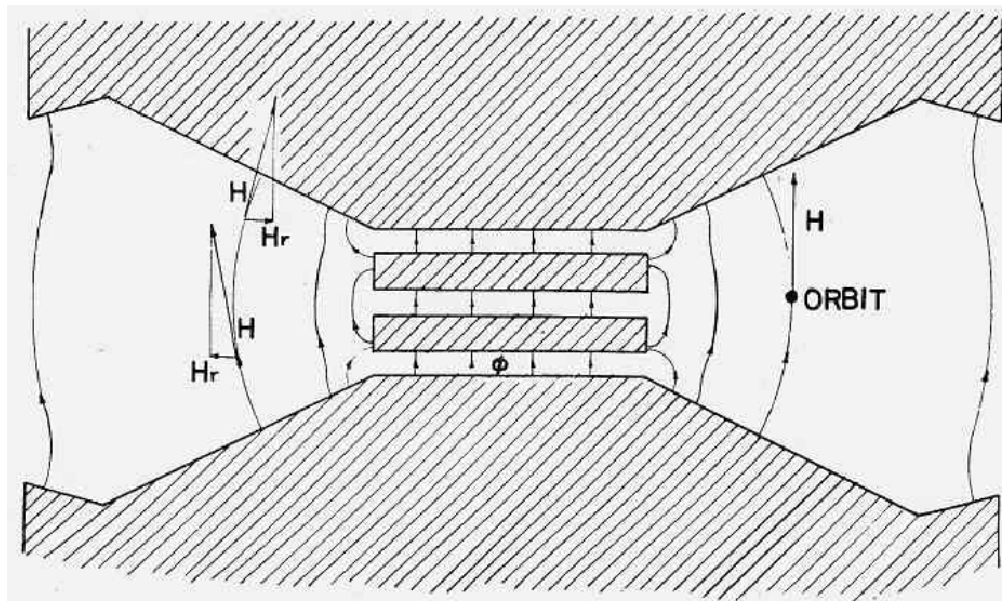

Fig. 2. Curvature of lines of force between the poles of the betatron. There is a radial component to the magnetic field everywhere except in the central plane. The radial component of magnetic field always forces electrons back toward this plane.

What it looked like in the 1940s :

Early betatron (not the first one) at University of Illinois.

A 4-ton dipole magnet device.

Kerst working on it.

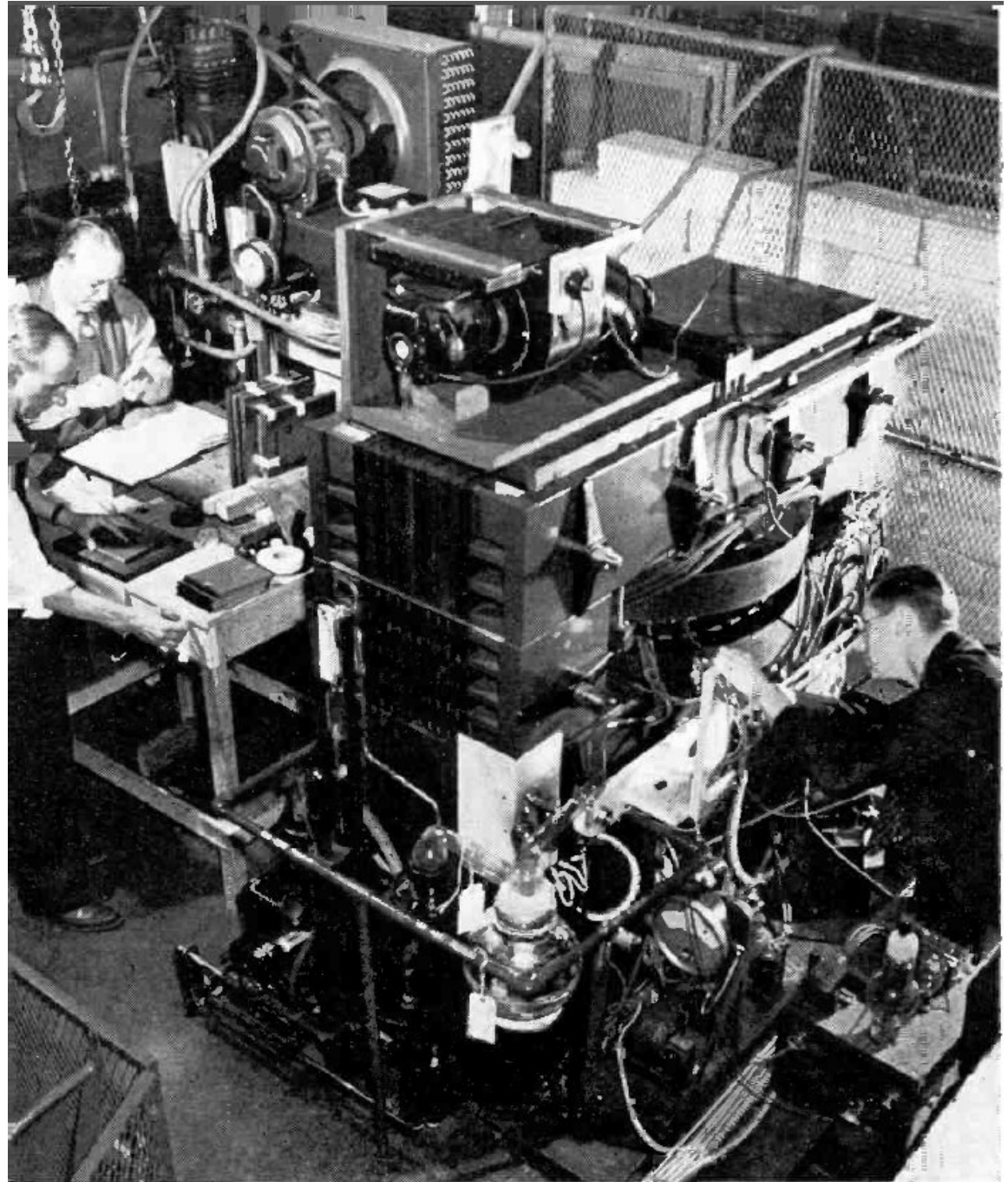

Another early specimen

6 MeV betatron, Germany, 1942.



1920s : The betatron method was invented to accelerate beta-rays (today's electron beams !)

to produce bursts of X-rays

- constant-radius orbit, the $B_{\text{induc}} = 2B_{\text{guide}}$ rule,

at the primary coil,

- the secondary coil – the beam - is in a vacuum tight donut.

• 1940 : that's when a complete theory of transverse stability would be formalized (Kerst & Serber).

It allowed bringing moving to realisation:

• 1940: production of X-rays from a 2.3~MeV e-beam (100 millicurie radium source equivalent): a breakthrough in medicine, material radioscropy.

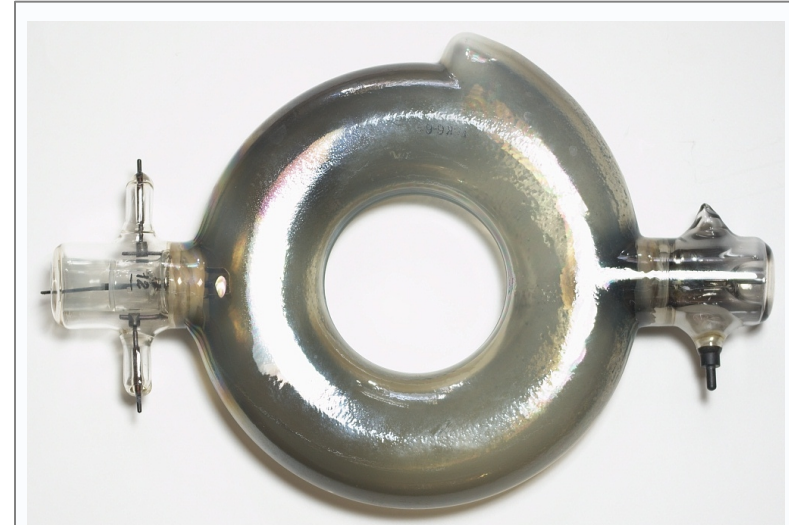

SVETLANA RBK6-6E Betatron 6 MeV. Manufacturing date around 1991. In-situ radiotherapy and radiographic non destructive testing: containers, ship hulls, weapons [Ref.: <http://lampes-et-tubes.info/xr/xr033.php?l=d>]

- **Kerst-Serber's betatron implements 3 technologies of that time:**
 - the ring method as used in cyclotrons, and pole shaping ($dB/dr < 0$) focusing in a similar way
 - induction acceleration, already known for many years
 - vacuum

The betatron is not a resonant accelerator, however, it is in key aspects the precursor of synchrotrons:

- the first constant-orbit ring, field and momentum rising together, magnetic field pulsed for that reason, acceleration cycled as a corollary,

- no problem to digest relativistic effects

- its understanding yielded the theory of “betatron motion” and its jargon as betatron frequency, betatron amplitude, betatron resonance...

- the first proof-of-principle synchrotron used an existing betatron magnetic structure.

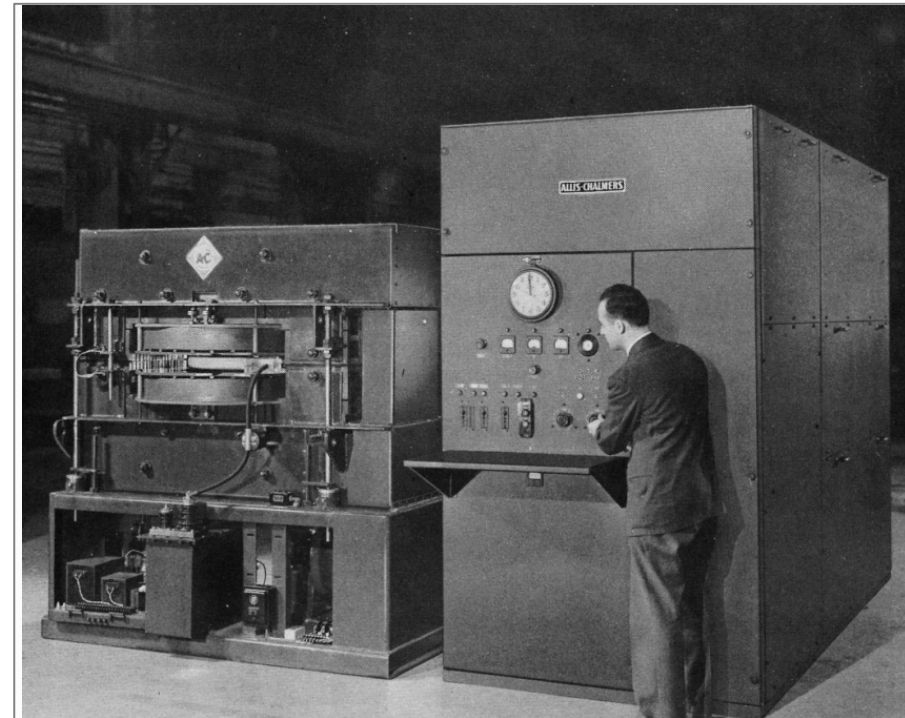

20 MeV betatron and control equipment
[Ref.:lampes-et-tubes.info/xr/xr033.php?l=d]

- **The 1940-1950 period saw increase to ultimate energy:
Kerst's 300 MeV machine, 100 mA for particle physics,
Limitations were magnet size, synchrotron radiation [1]**

The betatron would be outperformed in an interval of a few years,

- by linac in the medical application,

- by synchrotrons for higher electron energies demanded by nucleus and particle physics



HOW ABOUT IONS ?

The betatron concept does not present an interest for ions:

- at low energy, $v \ll c$, an ion would only get little energy increase over the short duration of a betatron pulse.

On the other hand large proton or deuteron rigidity, $BR = p/q$,

- means large magnet size (proton BR is for instance 2.4 Tm at 250 MeV, 5.7 Tm at 1 GeV, R respectively 1.6 m, 3.8 m for $B_{max} = 1.5$ T),

- whereas magnet core volume increase as R^3 in correlation with return flux.

Conclusion 1/2

- **Betatrons are produced nowadays essentially as light (portable) compact X-ray sources for material analysis, a few MeV energy range.**



[5] ADVANCED INSPECTION SYSTEMS. JME Portable 6 MeV. X-RAY BETATRON. Microprocessor model: PXB-6 M. Jun 15, 2010.

- **FFAG focusing was extended to the betatron in the 1950s, for the high energy acceptance of “zero-chromaticity” FFAG optics**
Induction acceleration in FFAG applied in the 2000s for high power electron beams (Japan R&D) → food sterilization, radiography
- **Note: strictly speaking, ramping field in synchrotron magnets causes inductive accelerating E-field. It is in principle a small effect...**

Conclusion 2/2

A parenthesis: induction acceleration

- The betatron method is one way to use it
- There are others, not to mention the induction linac... for instance in the recent past:
 - induction acceleration in a synchrotron (KEK)
- was proposed for long-bunch at LHC, early 2000s...

SYNCHROTRONS

**Main specificities,
compared to what
we have already
learned :**

PHASE STABILITY

(1944 - McMillan & Veksler)

STRONG FOCUSING

(1952 - Christofilos &

Courant, Livingston, Snyder)

Circular accelerator landscape, when longitudinal phase-stability was invented

Cyclotron

PSI, 590 MeV, not far from the ~ 1 GeV limit of this beam guiding technology.

However: high power!



Constant magnetic field
Gap RF voltage,
constant frequency

Betatron

Largest, late 1940s:
300 MeV

(first one, and Kerst, in foreground)



Pulsed magnetic field
Non-resonant
(induction)
acceleration

Synchro-cyclotron

CERN's 600 MeV, close to ~ 1 GeV limit of this cyclotron-type guiding technology.

Closed 1990



Constant magnetic field
Gap RF voltage,
modulated frequency

None of these technologies has disappeared: cyclotrons, betatrons, synchro-cyclotrons, are still fabricated, but that's not for high energy applications.

Genesis

- Cyclotrons and betatrons appeared limited in energy by size of dipole magnet.
- At highest B, increase E meant increase $B \times 2\pi R$ in proportion, whereas unfortunately magnet volume goes like R^3 .

Largest cyclotron was already equivalent volume of metal of a battleship...
Doubling the energy meant a battleship fleet...[1]

- An idea which was in the air, instead: a thin ring of magnets based on a fixed-radius orbit as in the betatron

and pulse B to follow E increase → acceleration is cycled

If a separate oscillating voltage gap is arranged at some location(s) in the ring (at the manner of the cyclotron voltage gap), it avoids the central yoke of the betatron.

- The energy gain per turn can be moderate, unlike cyclotron which needs high V to avoid isochronism, and as in the betatron.

It just means hundreds of thousands of turns... not a problem!

$\sim 1\text{GeV} / 10\text{kV} \sim 10^5$ turns → 10^5 C / c $\sim 3 \times 10^6 / 3 \times 10^8 \sim$ tens of ms

- Focusing inherits directly from proven betatron or cyclotron technique, $0 < n = -R/B dB/dR < 1$ in all bending magnets, “weak focusing” in nowadays jargon
- Oliphant, Memo to UK DAE, 1943: *“Particles should be constrained to move in a circle of constant radius thus enabling the use of an annular ring of magnetic field ... which would be varied in such a way that the radius of curvature remains constant as the particles gain energy through successive accelerations by an alternating electric field applied between coaxial hollow electrodes.”*

1994-Veksler; 1945-McMillan: discovery of the phase stability. That makes it possible!

Phase Stability in a Synchrotron

- From the definition of η it is clear that an **increase in momentum** gives
- **below transition** ($\eta > 0$) a **higher revolution frequency** (increase in velocity dominates) while
 - **above transition** ($\eta < 0$) a **lower revolution frequency** ($v \approx c$ and longer path) where the momentum compaction (generally > 0) dominates.

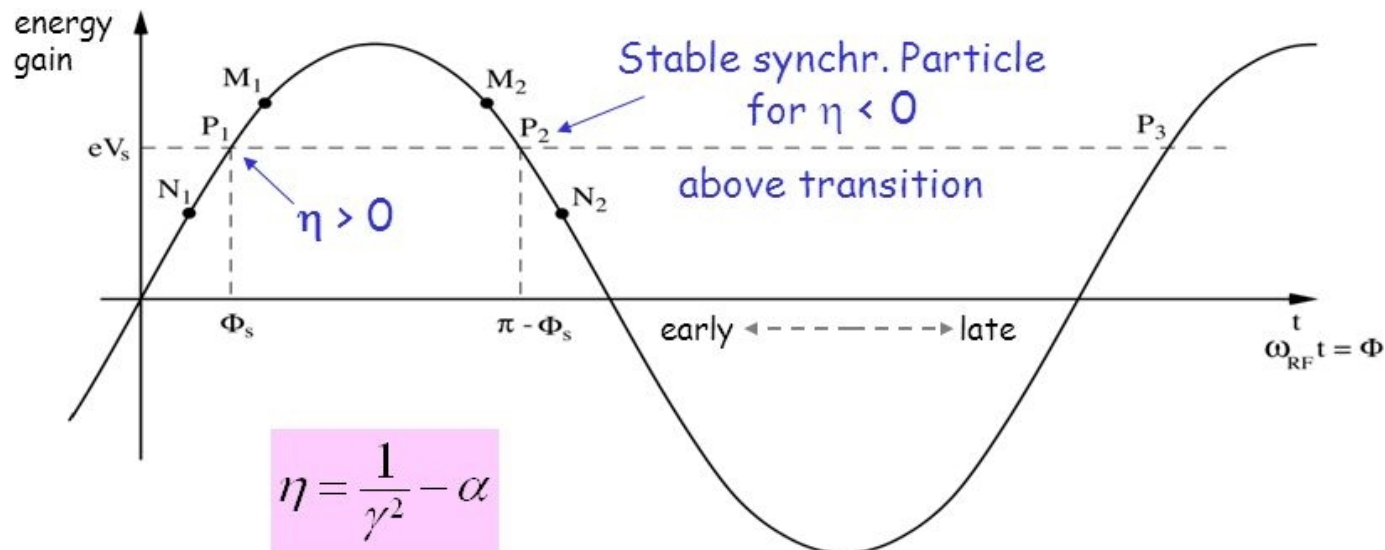

1946, Aug.: First synchrotron, 8 MeV proof-of-principle, operated by Goward in Woolwich, UK

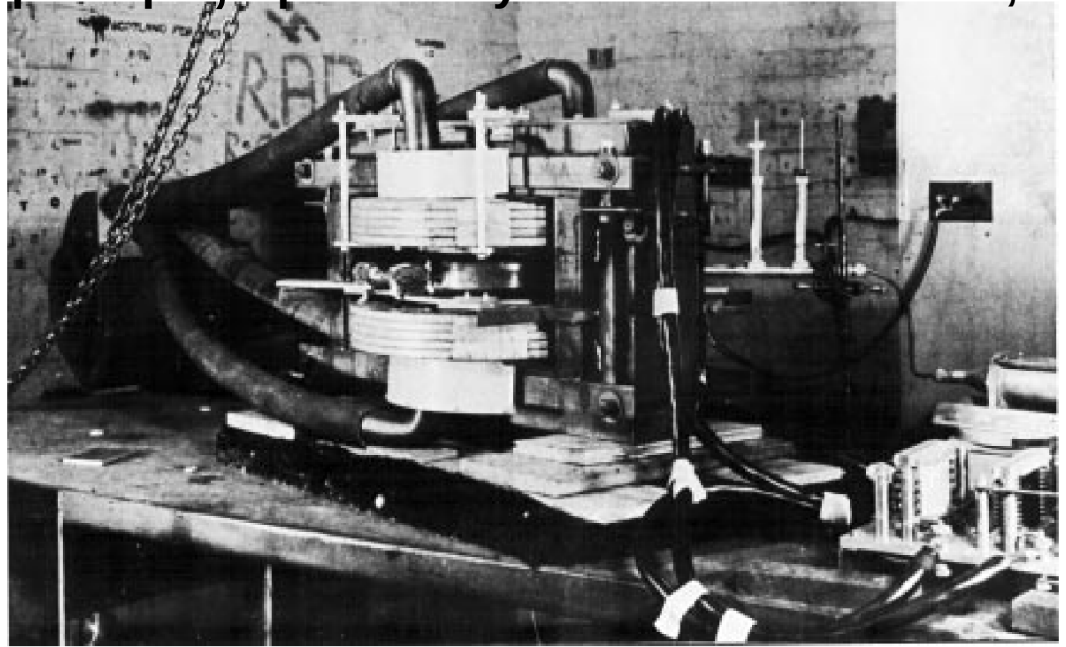

Fig. 4: The world's first synchrotron, installed at Malvern. The extra cooling system and RF feed to the resonator may be clearly seen.

1947: First observation of synchrotron light (SR), not fully understood (spectrum etc.) - Julian Schwinger would develop a full theory of SR in a circular accelerator



Vacuum chamber of GE synchrotron

[Ref.:Alamy.com]

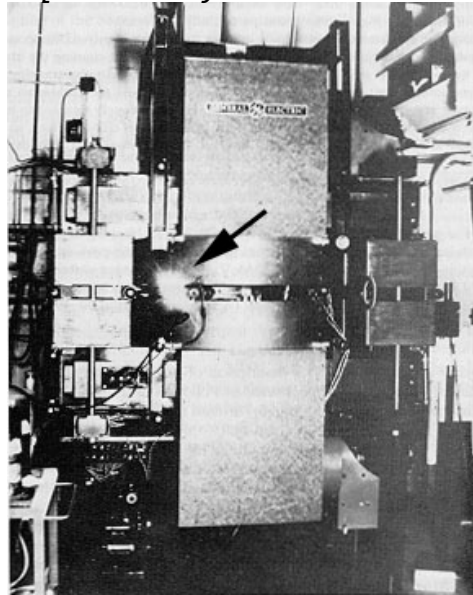

70 MeV synchrotron, GE

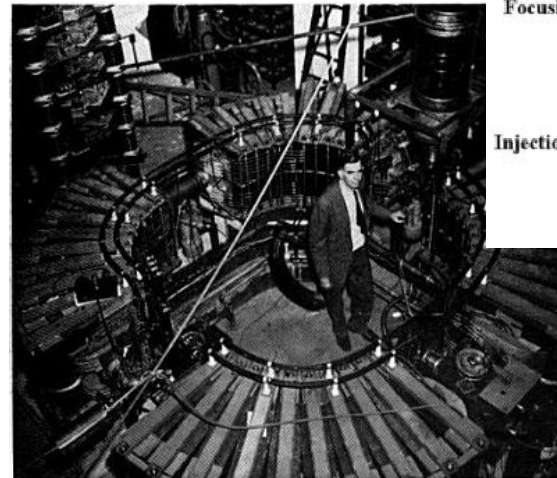

The first "racetrack" synchrotron with straight sections, 300 MeV electron, University of Michigan, 1949.

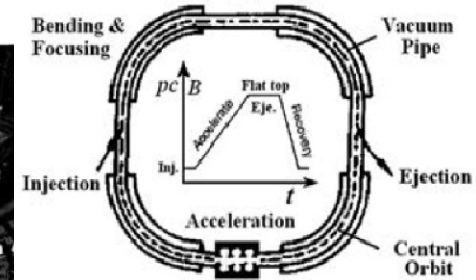

RACE FOR HIGH ENERGIES

Cosmotron (1952-1966) - The first >1 GeV ring, proton

April 1948, the Atomic Energy Commission approves a plan for a proton synchrotron to be built at Brookhaven.

Reached its full design energy of 3.3 GeV in 1953.

The first synchrotron to provide an external beam of particles for experimentation outside the accelerator.

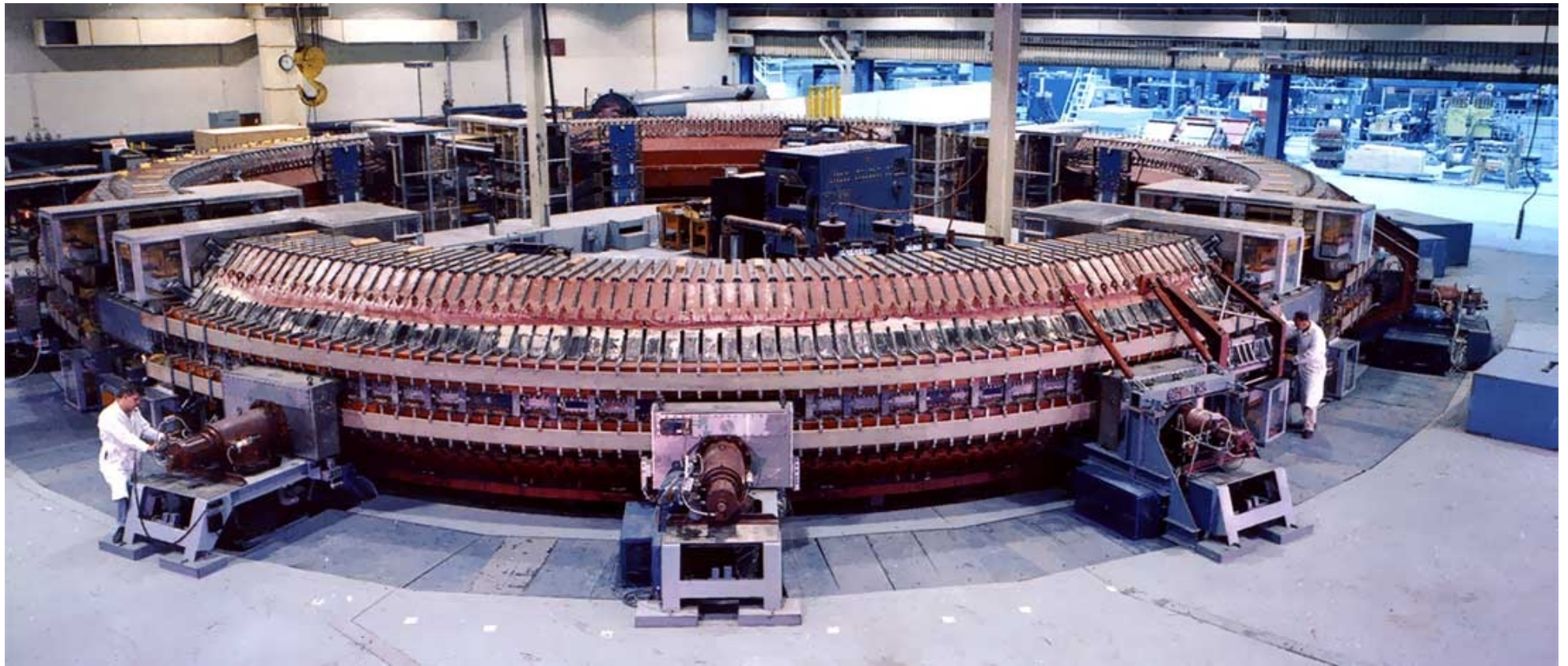

Beam goes to experimental areas

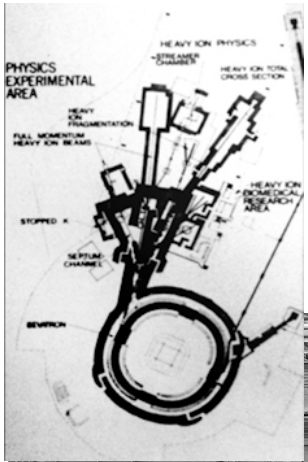

1954-1993: 6 GeV Bevatron, Berkley 1954: 1st ion-therapy treatment 1971: New life as "Bevalac", ions

Construction

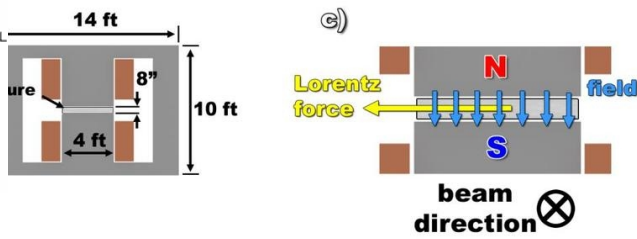
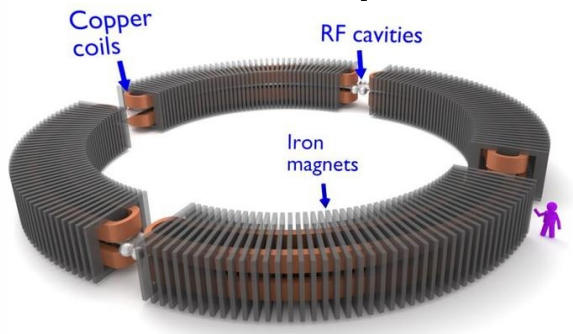
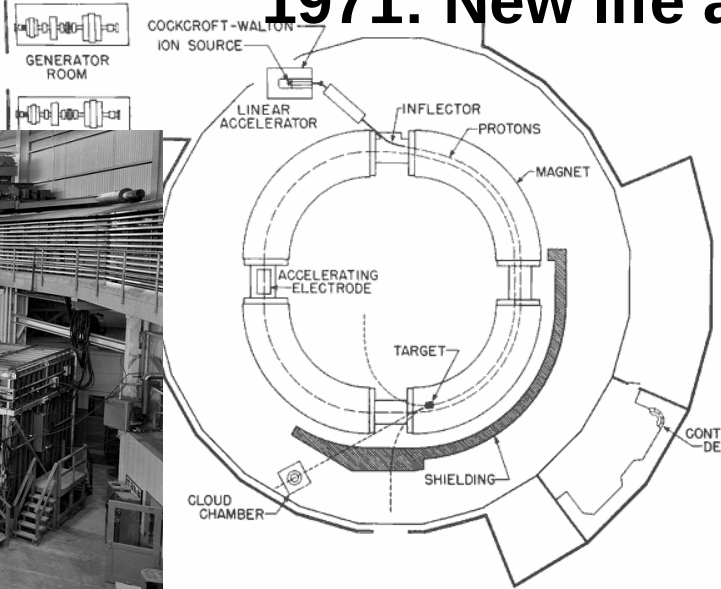
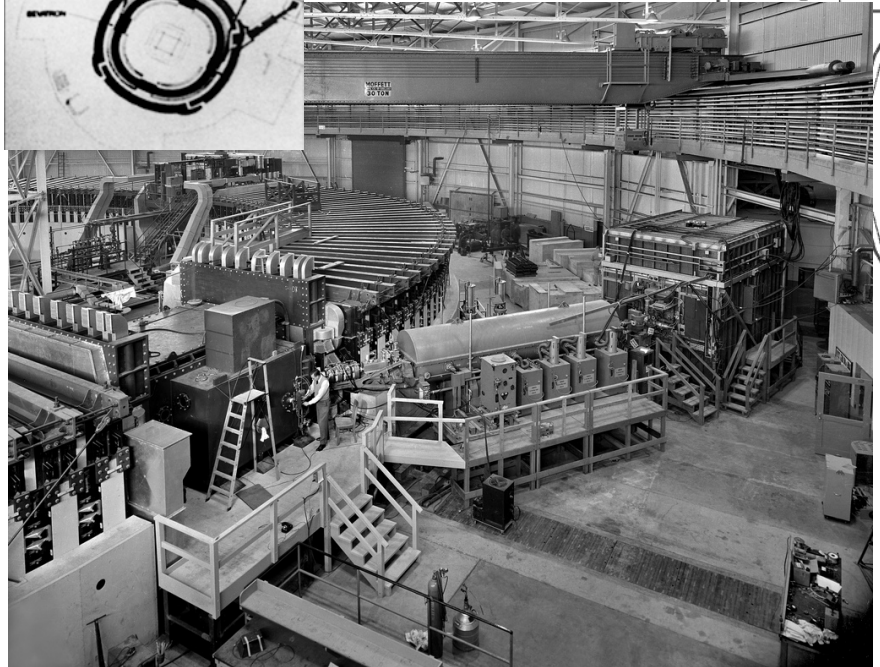

Control room



Power supplies

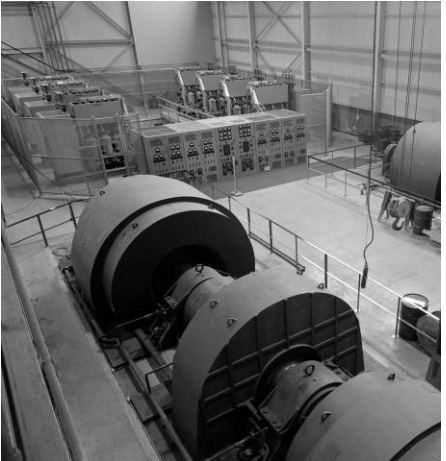

Overview of the Berkeley Bevatron during its construction in the early 1950s. One can just see the man on the left.

In spite of the discovery of “strong focusing”, in 1952

- meaning much smaller magnets,**
- weak focusing remained the preferred choice of the cautious,**
- and the Cosmotron was followed by:**

ZGS at Argonne,

Synchrophasatron in Dubna,

Saturne in France

and Nimrod in the UK.

SATURNE 1, at Saclay,
inaugurated in October 1958.



SATURNE 1, Saclay (1958-1970) 3 GeV

Plans for polarized proton
at SATURNE 1 motivated
Froissart-Stora theory on
the effect of depolarizing
resonances.

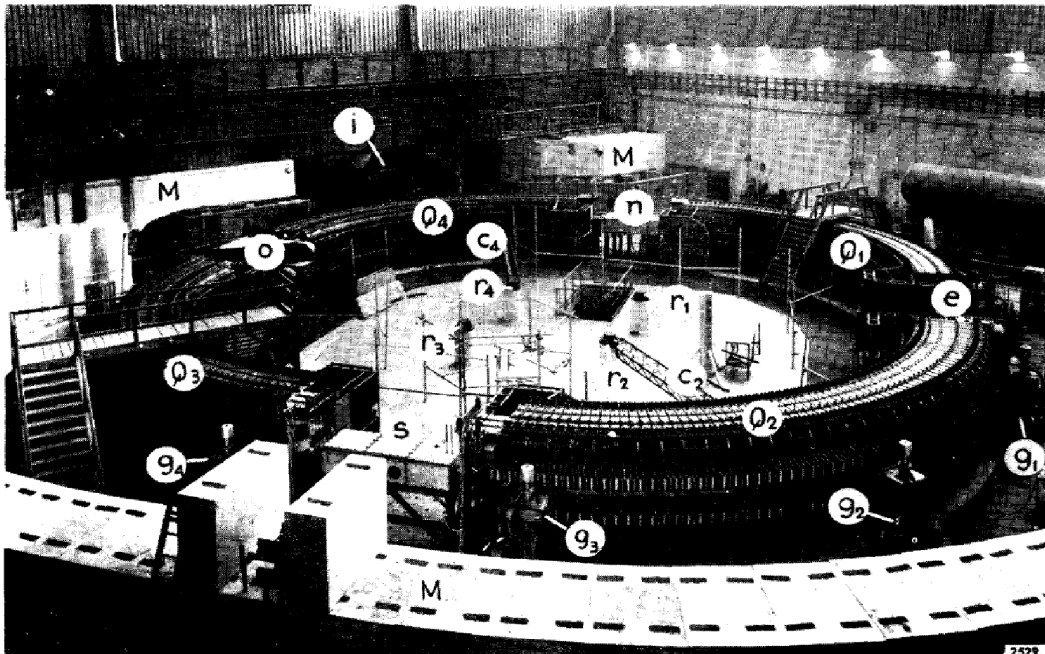
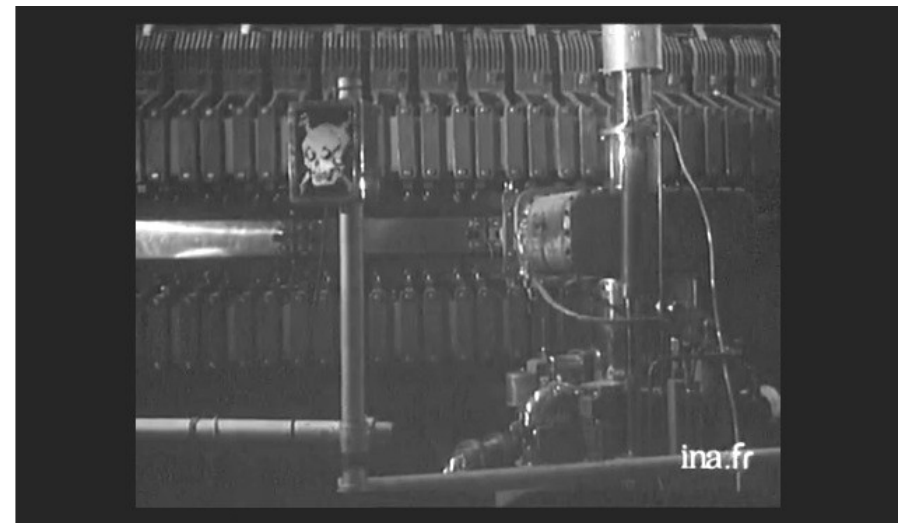

Figure 1. Vue générale de Saturne.



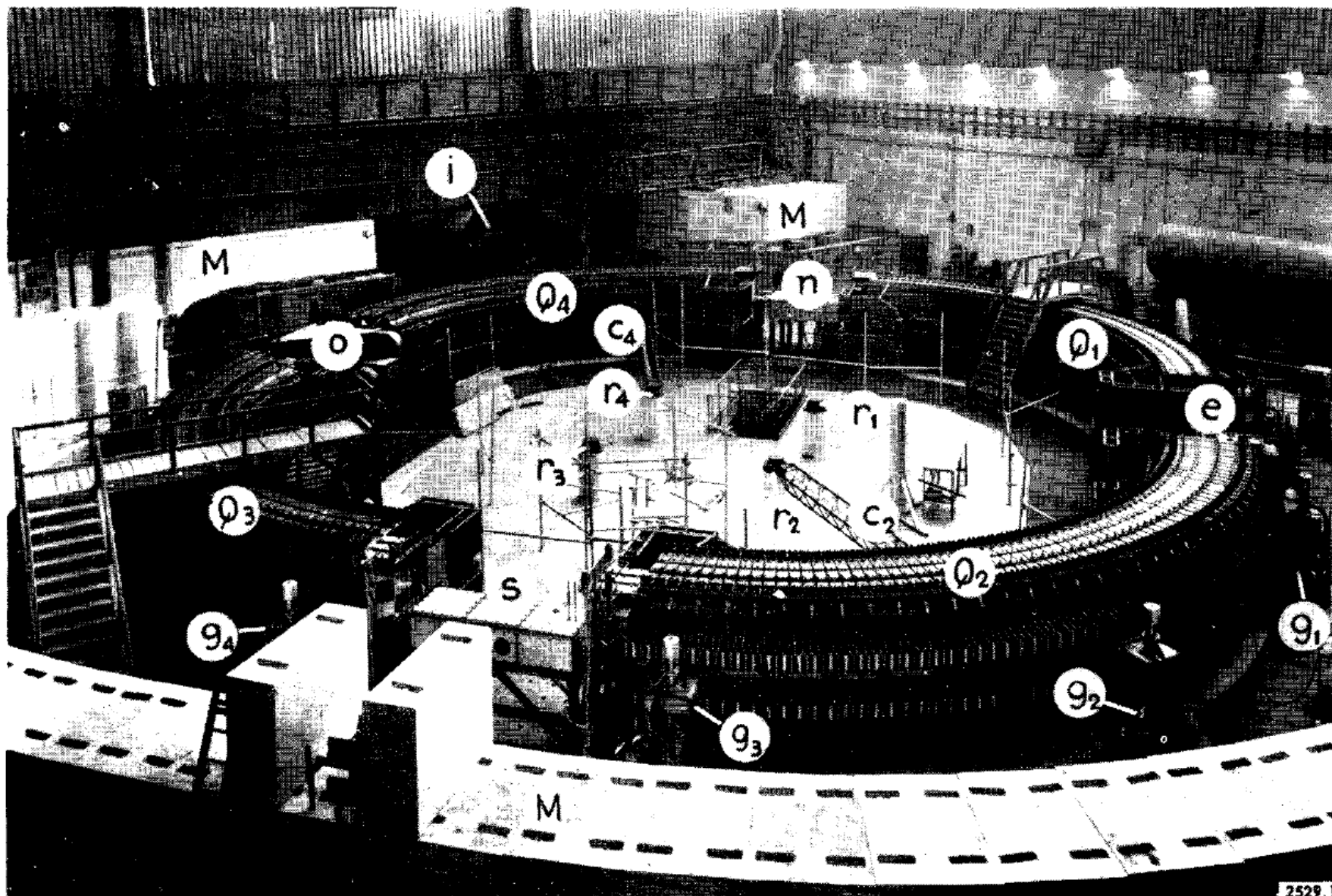

Figure 1. Vue générale de Saturne.

Q_1, Q_2, Q_3, Q_4 = Quadrants de l'aimant. n = Section droite nord contenant l'inflecteur d'injection. e = Section droite est contenant les électrodes de détection du faisceau. s = Section droite sud dans laquelle seront montés les dispositifs d'éjection du faisceau. o = Section droite ouest contenant la cavité HF d'accélération. J = Générateur électrostatique d'injection. g_1 à g_4 = Quatre des douze groupes de pompage de la chambre à vide. r_1 à r_4 = Références matérialisant les centres des quatre quadrants. Ces références et une référence centrale ont servi à mettre les blocs de l'aimant en position. Deux compas de mesure c_2 et c_4 sont encore en place. M = Différentes parties du mur de protection.

The 10 GeV Synchrophasotron (1957-2003) JINR, Dubna

Accelerated protons and Deutons

Constructed under the supervision of
Vladimir Veksler

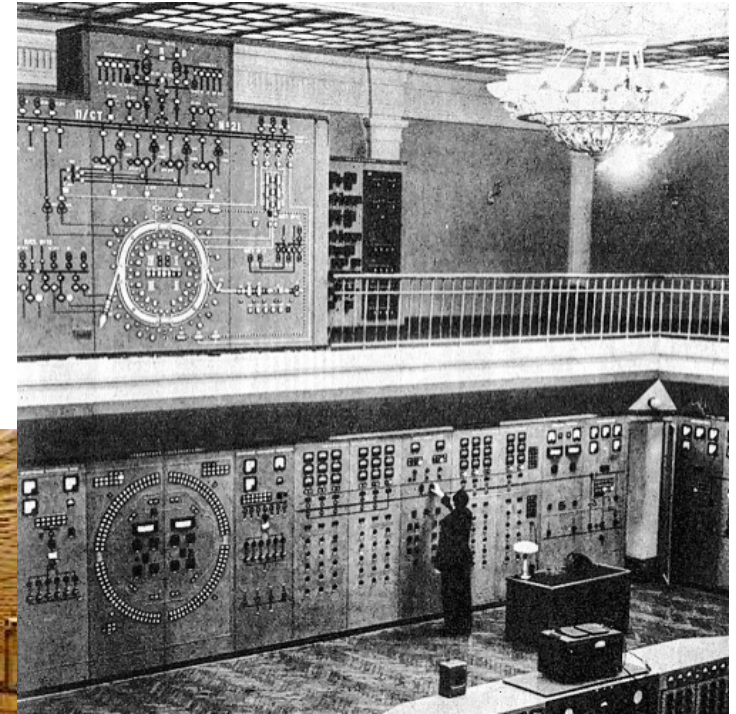
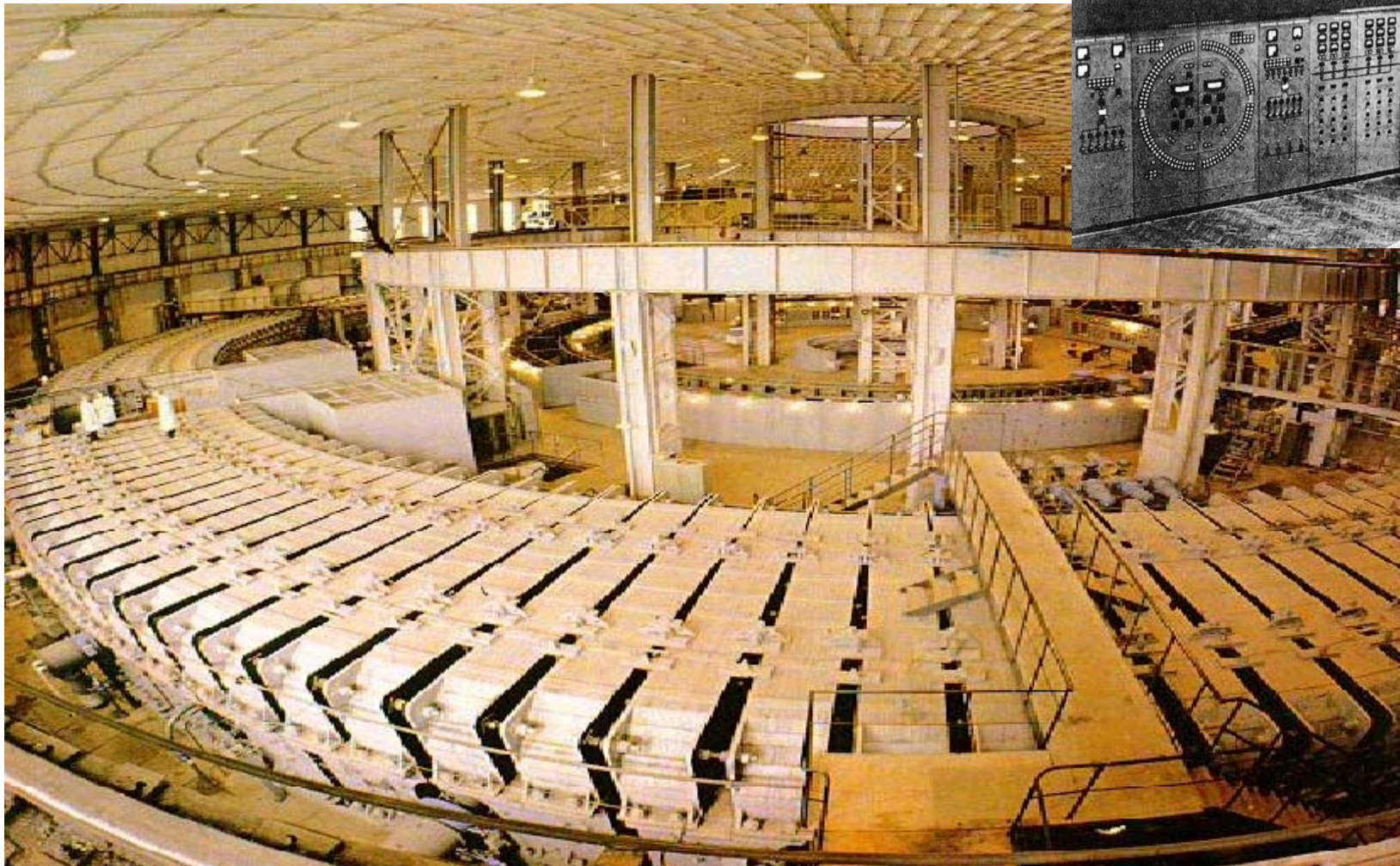

THE FALL OF THE WEAK FOCUSING SYNCHROTRON

...was essentially a matter of dipole magnet aperture:

- the Cosmotron aperture was 1.2 by 0.22 m

which had great consequences anyway – as the photos show,

- given $B_{\text{gap}} = \mu NI$, larger gap means larger NI

→ great I , big coils, big yokes, big vacuum chambers, big pumps...

and – finally ! resulted from the application of “strong focusing”
discovered in 1952.

WEAK FOCUSING SYNCHROTRONS NOWADAYS

Medical application essentially

**A technically cool (dipole is easy, just 1 type of magnet x 4),
and cost-friendly,**

**way to get proton beams in the cancer-therapy range of energy
→ up to 250MeV for 35 cm Bragg peak penetration in water.**

The Proton Treatment Center at Loma Linda University Medical Center.

The first hospital-based proton facility.
Construction 1988-1990.

1 of ~40 proton centers worldwide

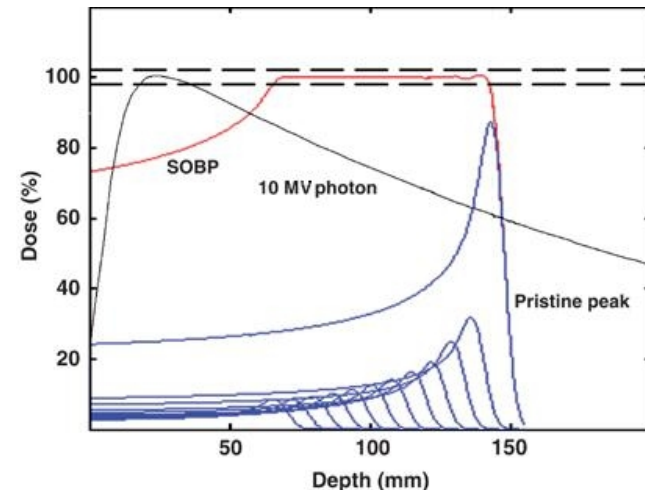

Facility Layout

Stationary Beam:

Has two branches:
•Eye Tumors
•Head and Neck Tumors

The Gantries:

Resembling giant ferris wheels can rotate around the patient and direct the proton beam to a precise point. Each gantry weights about 90 tons and stands 3 stories tall. It supports the bending and focusing magnets to direct the beam.

The Injector:

Protons are stripped out of the nucleus of hydrogen atoms and sent to the accelerator.

Synchrotron: (Accelerator)

A ring of magnets, 20 ft. in diameter, through which protons circulate in a vacuum tube.

Beam Transport System:

Carries the beam from the accelerator to one of four treatment rooms. This system consists of several bending and focusing magnets which guide the beam around corners and focus it to the desired location.

Steel-reinforced concrete walls are up to 15 feet thick.

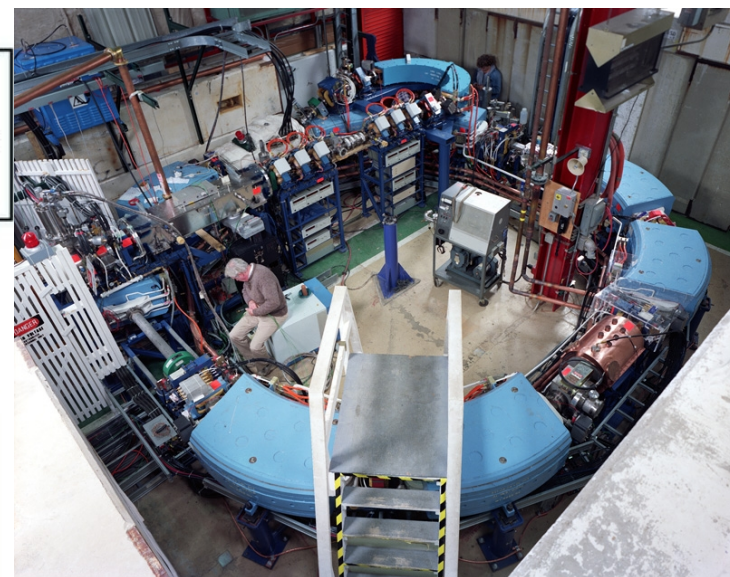
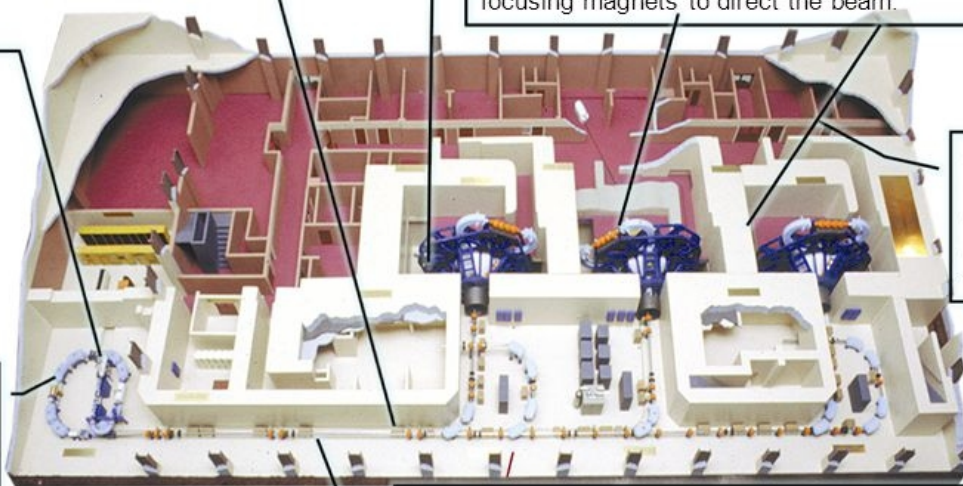

Components of a strong focusing, separated function synchrotron

- **Steering :**
bending magnets
- **Focusing :**
Quadrupole magnets
- **Acceleration :**
RF cavity (ies)
- **Injection, extraction**
- **Beam life time:**
vacuum chamber

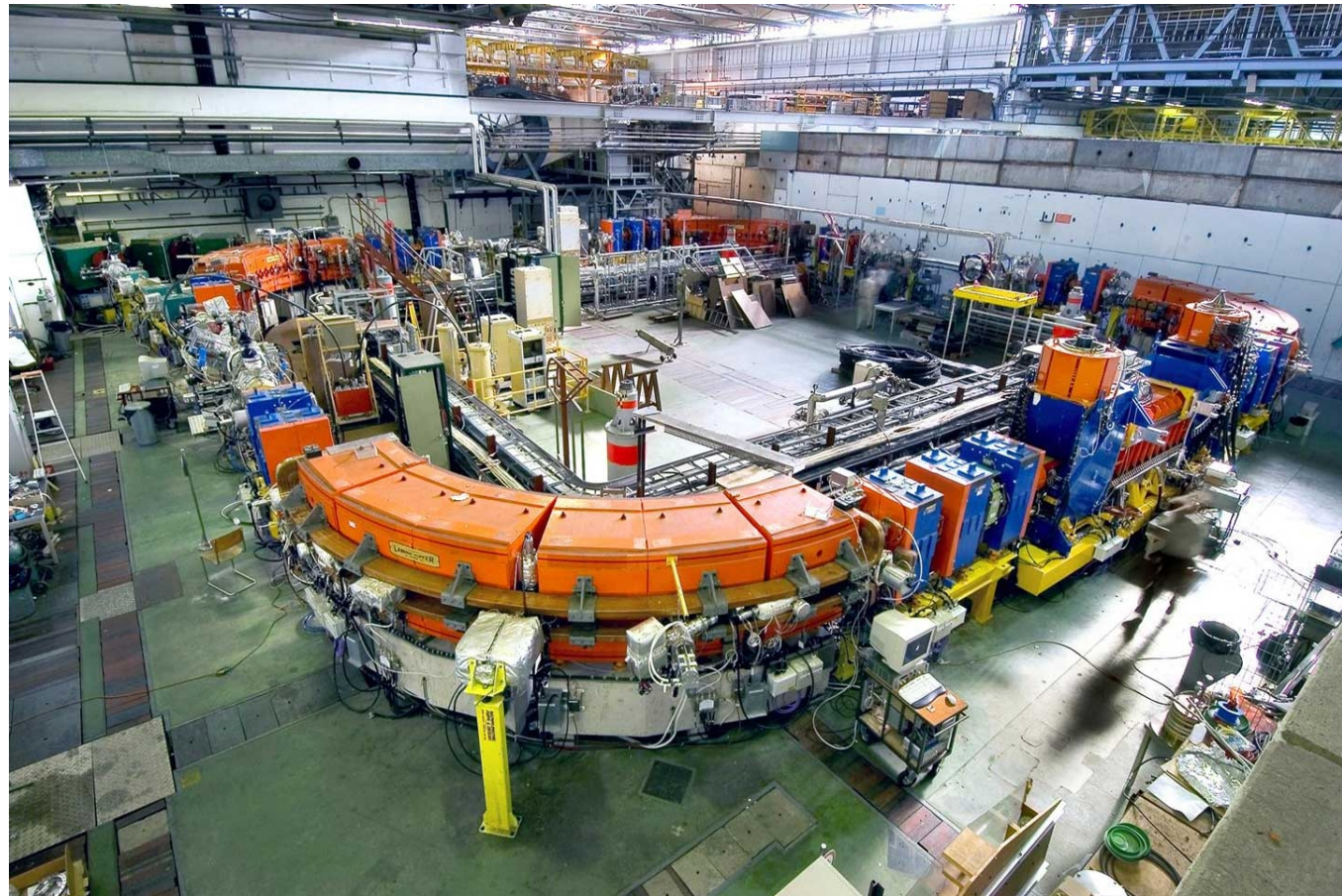

LEIR at CERN

LIGHT SOURCES

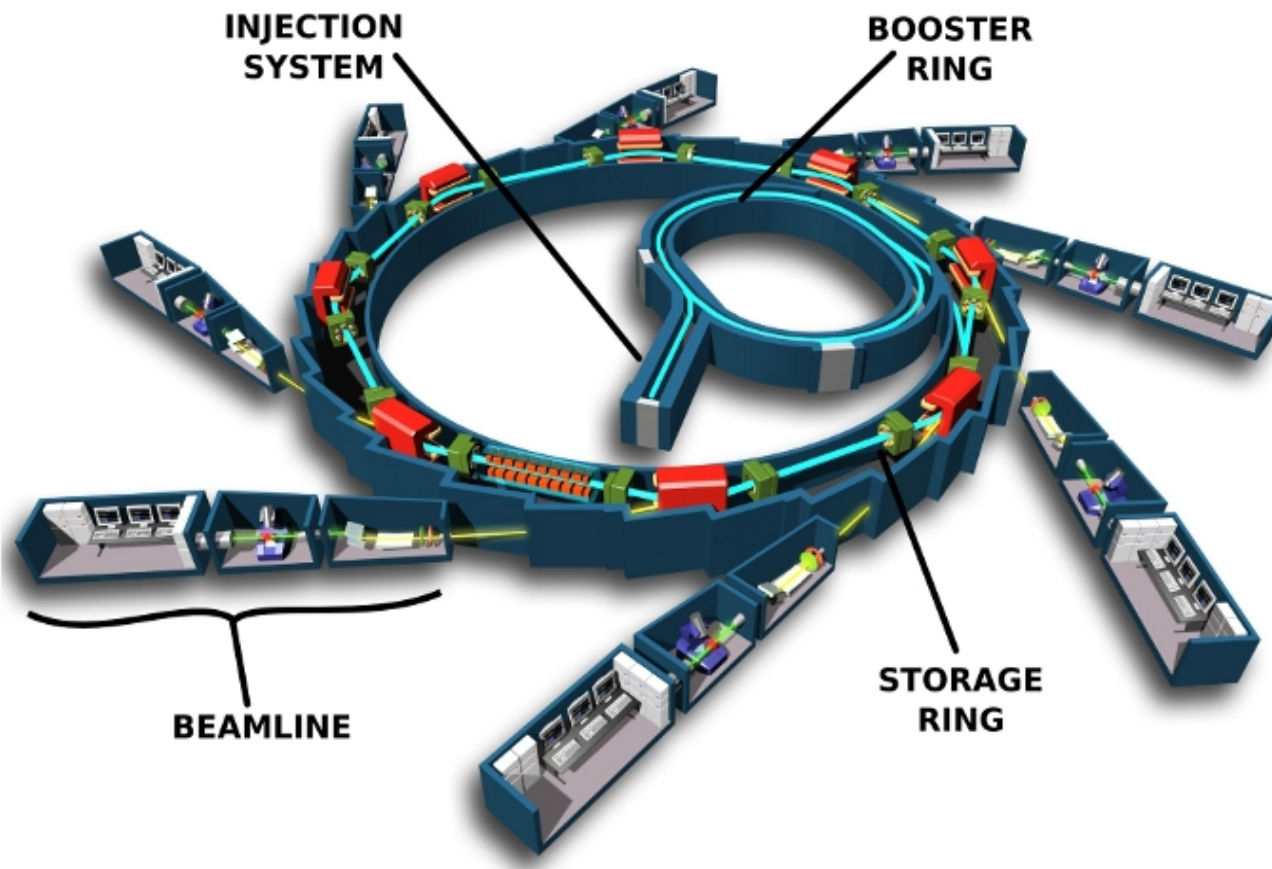

How this started

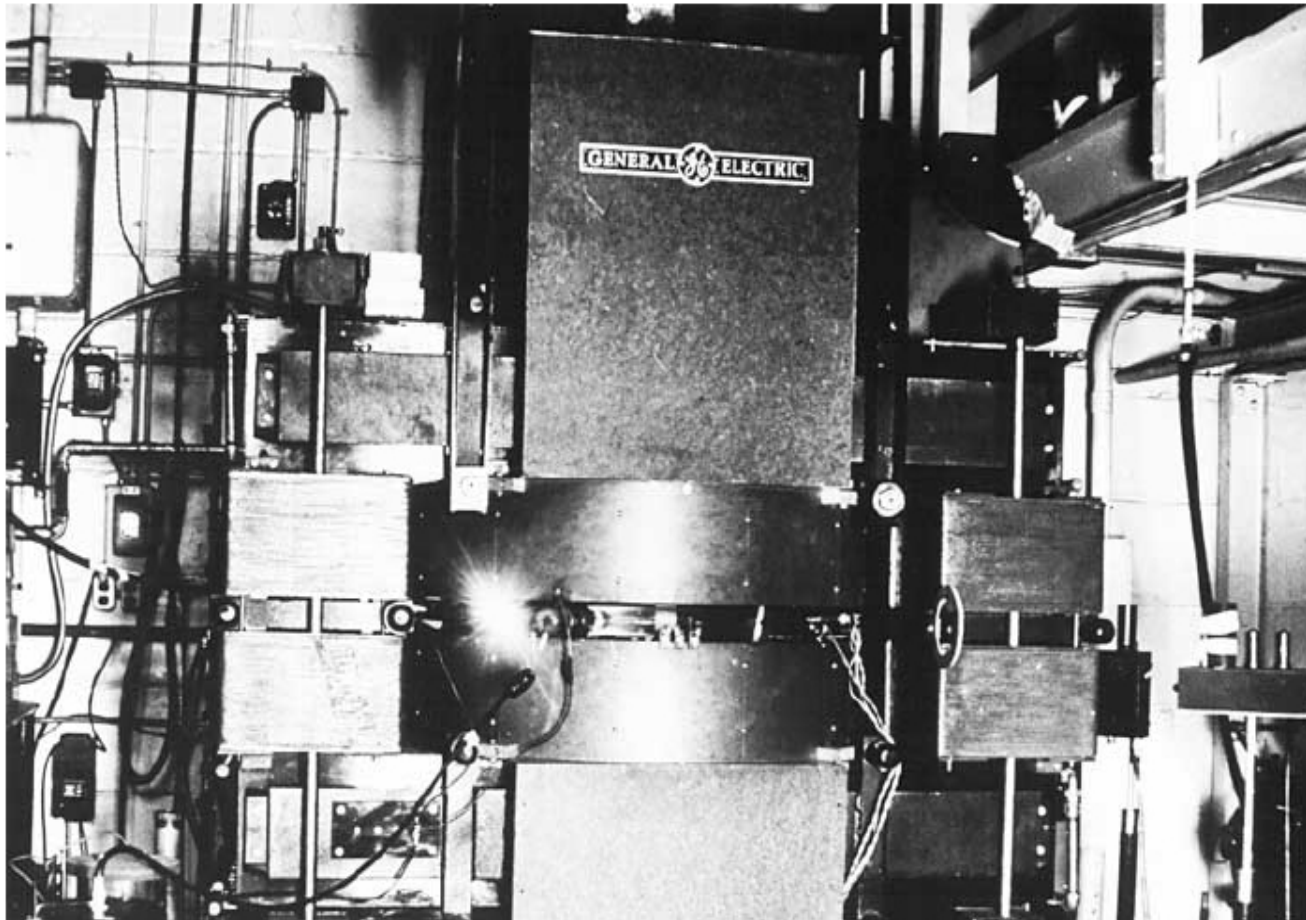

The 300 MeV electron synchrotron built at General Electric Co. in 1940s. The photograph shows the synchrotron radiation emitted from the accelerator.

NSLS2, BNL

Brand new, just started



A ring FEL

- **The ring** is similar to, *or just is*, a ring light-source.
- The FEL undulator and mirror cavity are inserted in a straight section in the ring
- An complex evolution of the ring FEL, with even higher brilliance, is the “**optical klystron**”

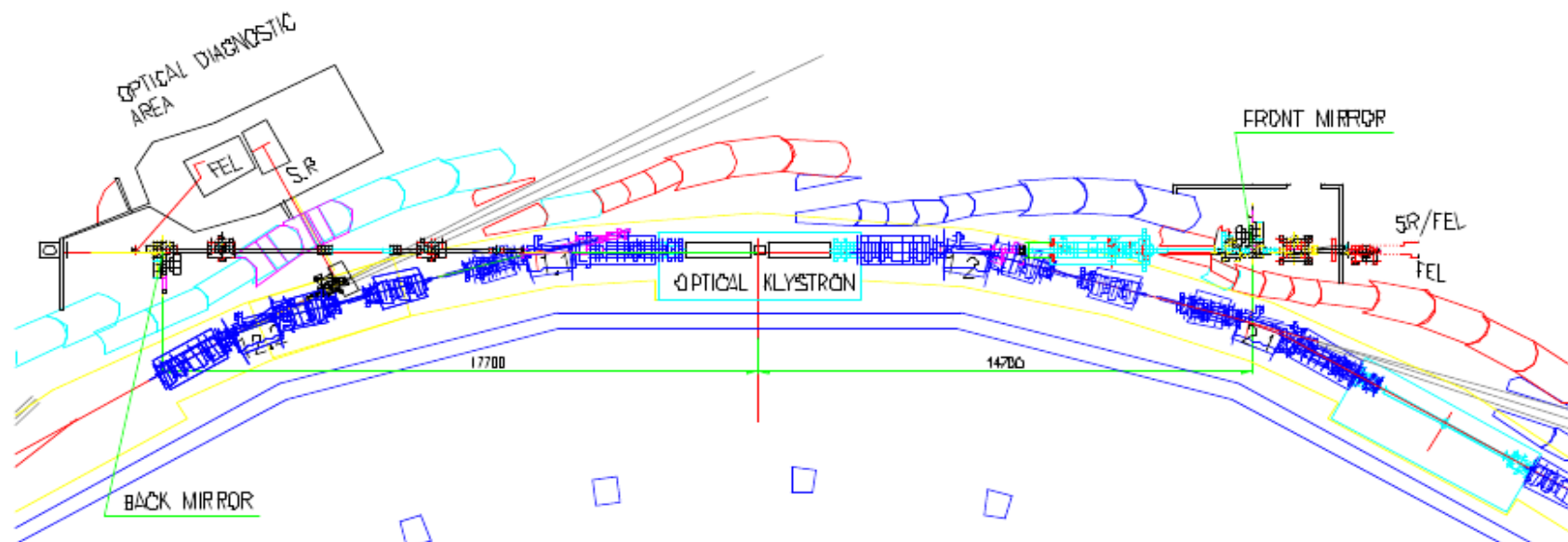
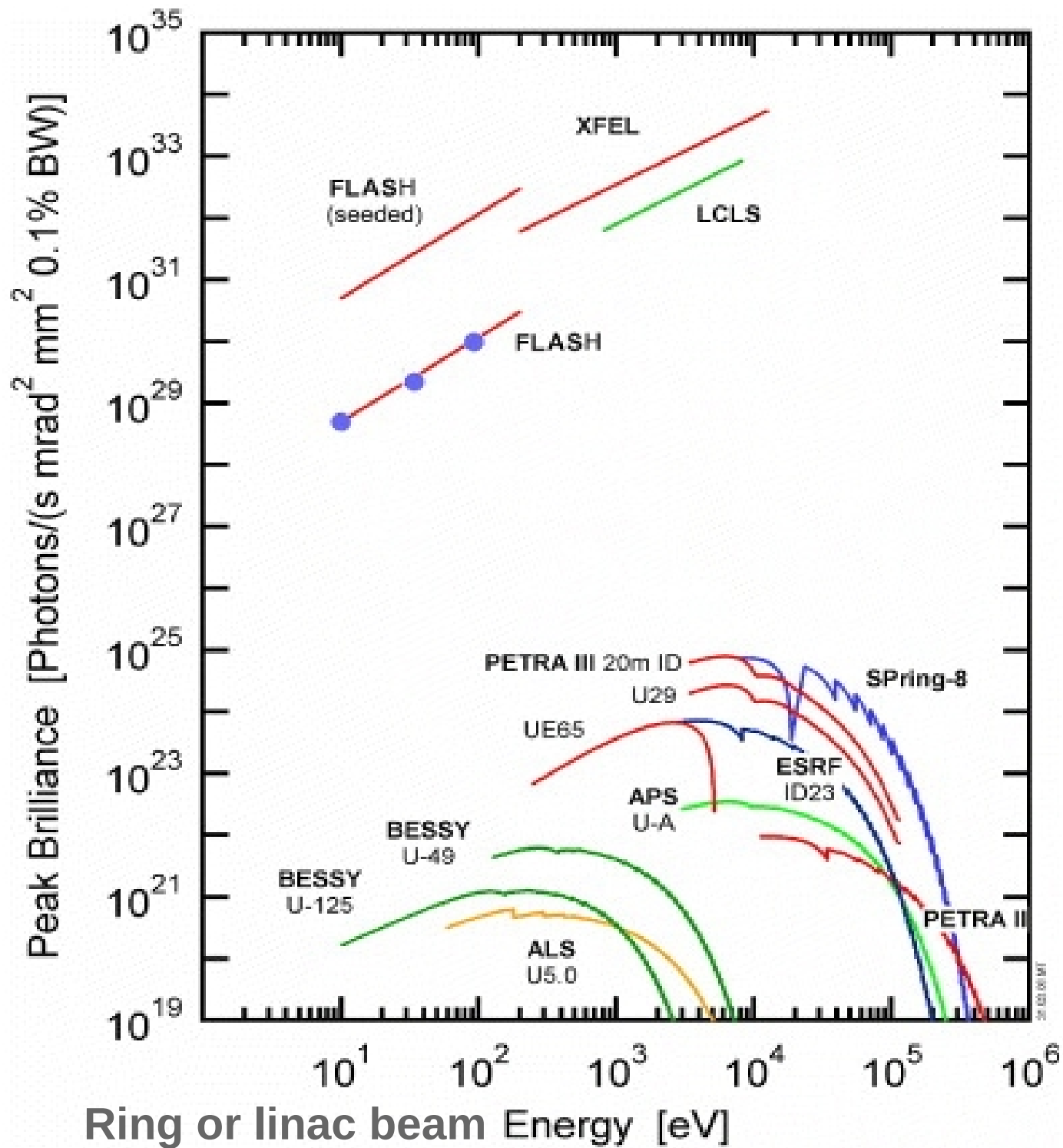

Figure 1: Layout of the Free-Electron Laser in the ELETTRA storage ring.



HEP

**There are 2
LARGE COLLIDERS LEFT
ON THIS PLANET
(*duno about other planets :)*)
- *hadron colliders, rings* -**

COLLIDERS - A LONG HISTORY, TOO

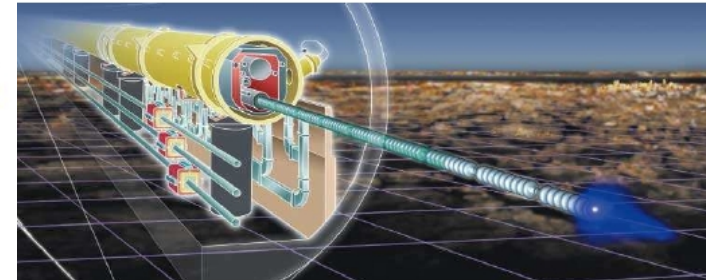
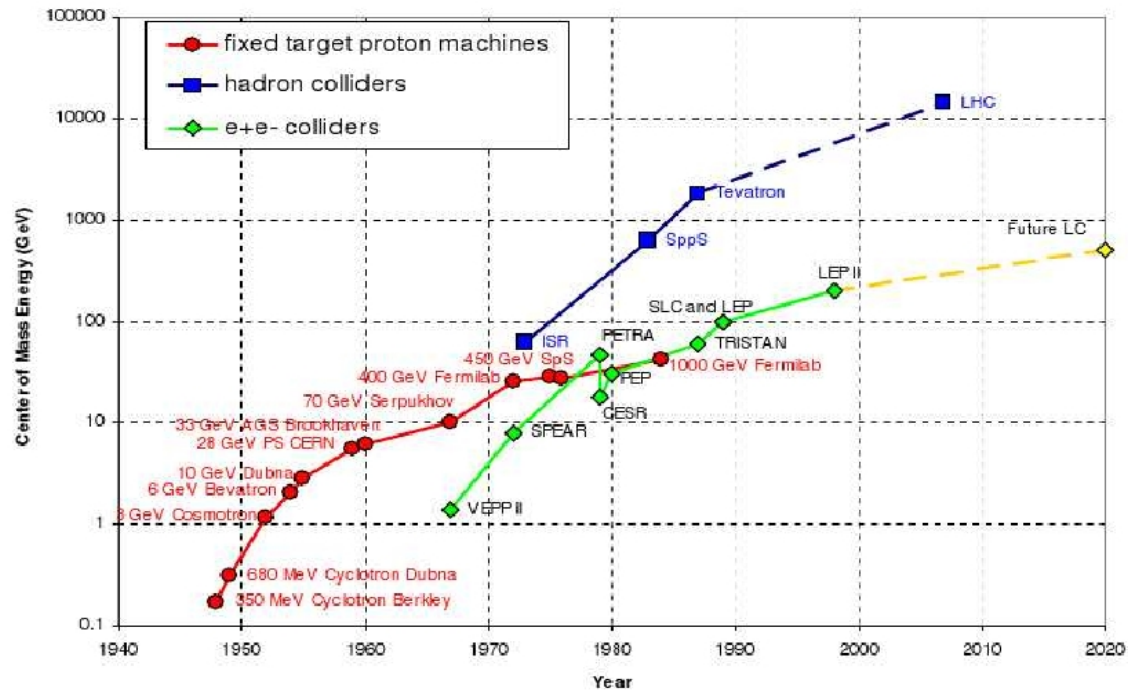

- The CM energy available in a collision between two particles, (1), (2), writes

$$E_{CM} = \sqrt{M_1^2 + M_2^2 + 2M_1M_2\gamma_1\gamma_2(1 - \beta_1\beta_2)}$$

- Considering particles with the same mass M , in fixed target collision mode, incoming beam with energy E , one gets

$$E_{CM} \approx \sqrt{2ME}$$

The energy available goes as the square root of the accelerator energy

- Considering particles with the same mass M , in collider mode, beams with respective energies E_1 , E_2 , head-on collision, one gets

$$E_{CM} \approx 2\sqrt{E_1E_2}$$

RHIC

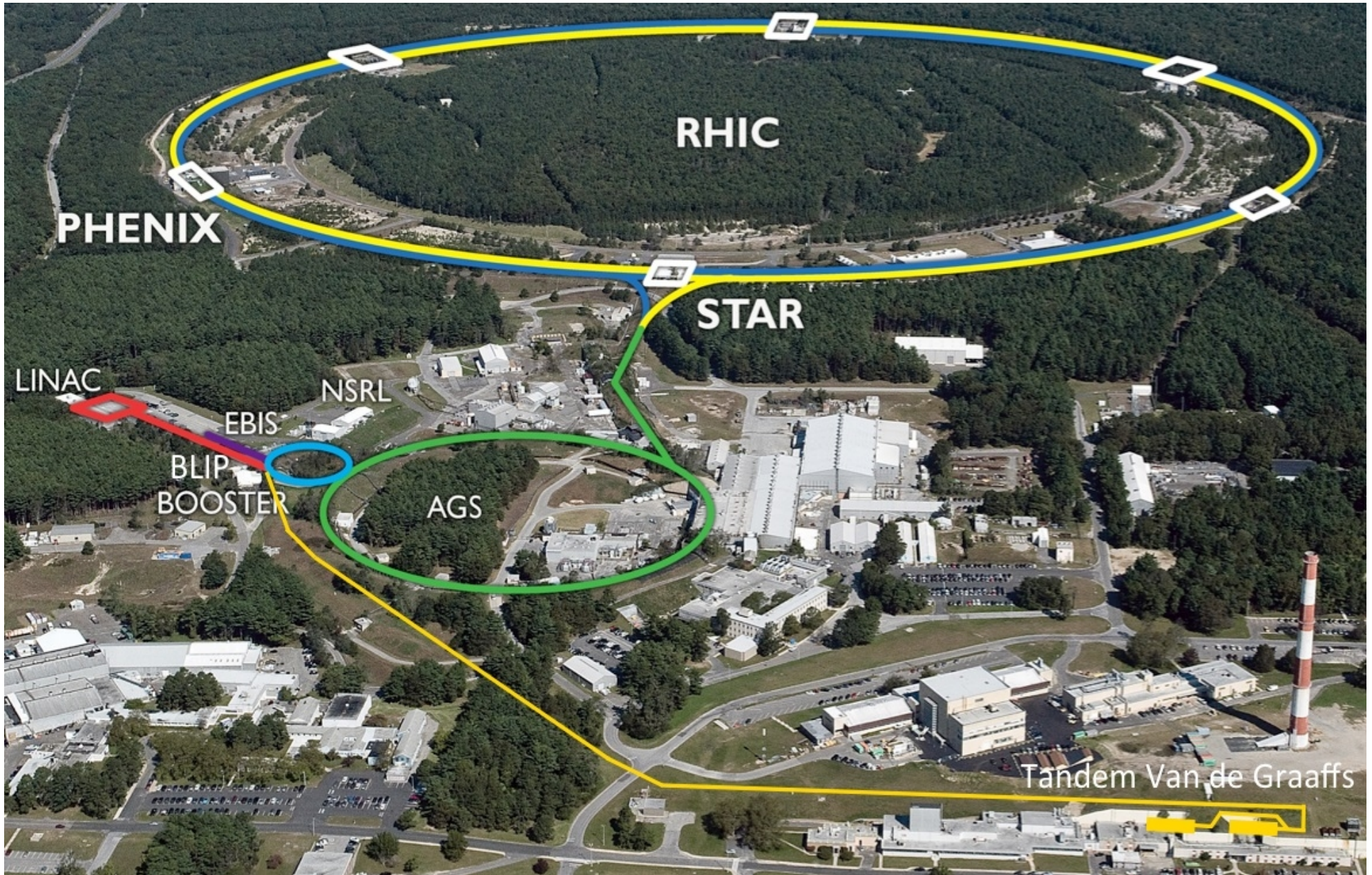



HIC

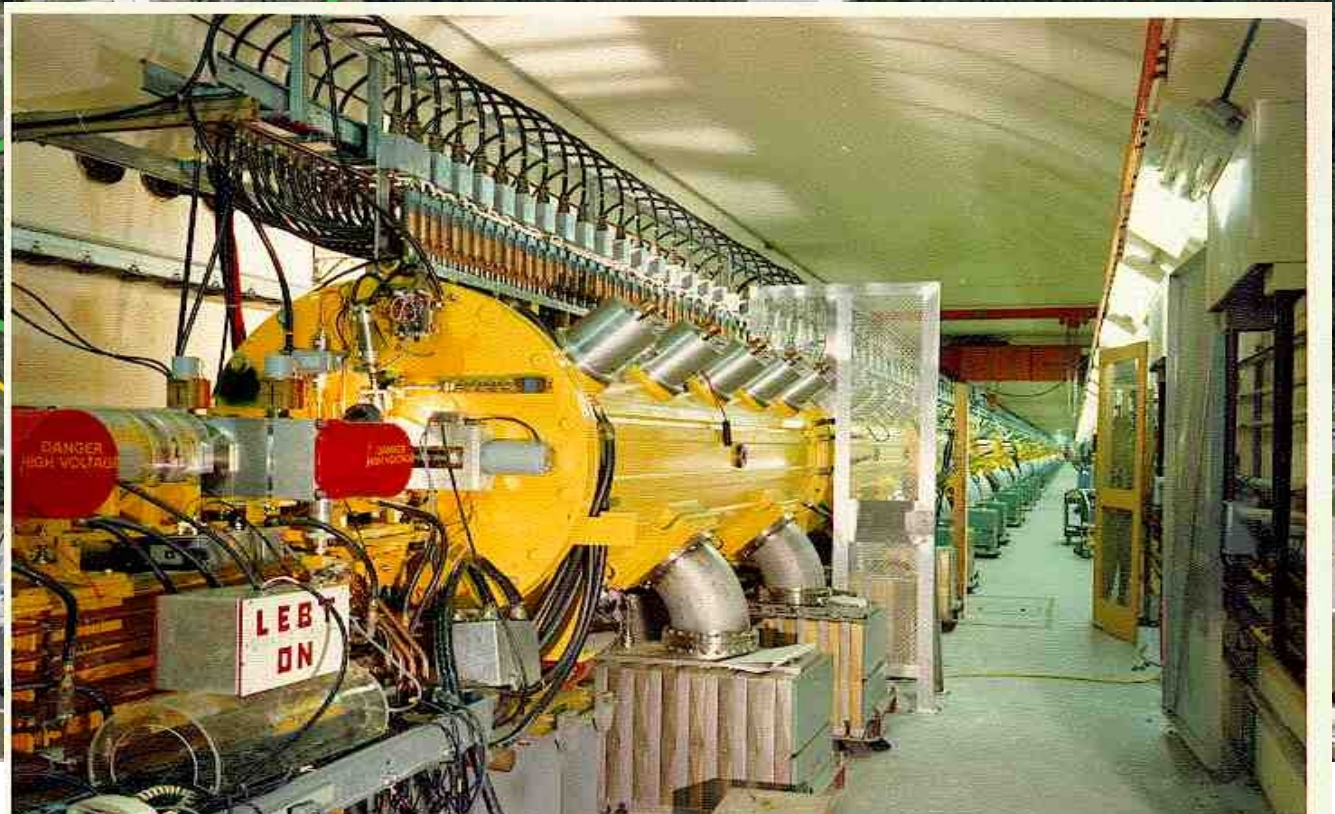
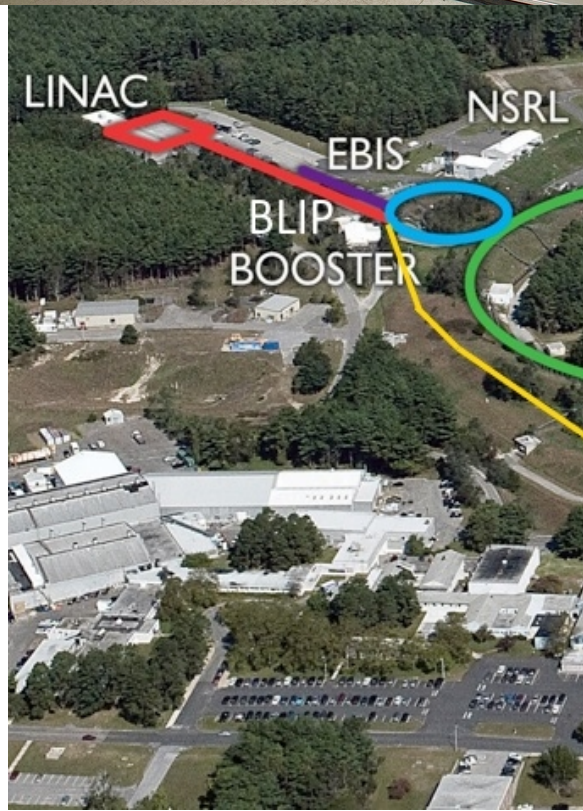

ffs

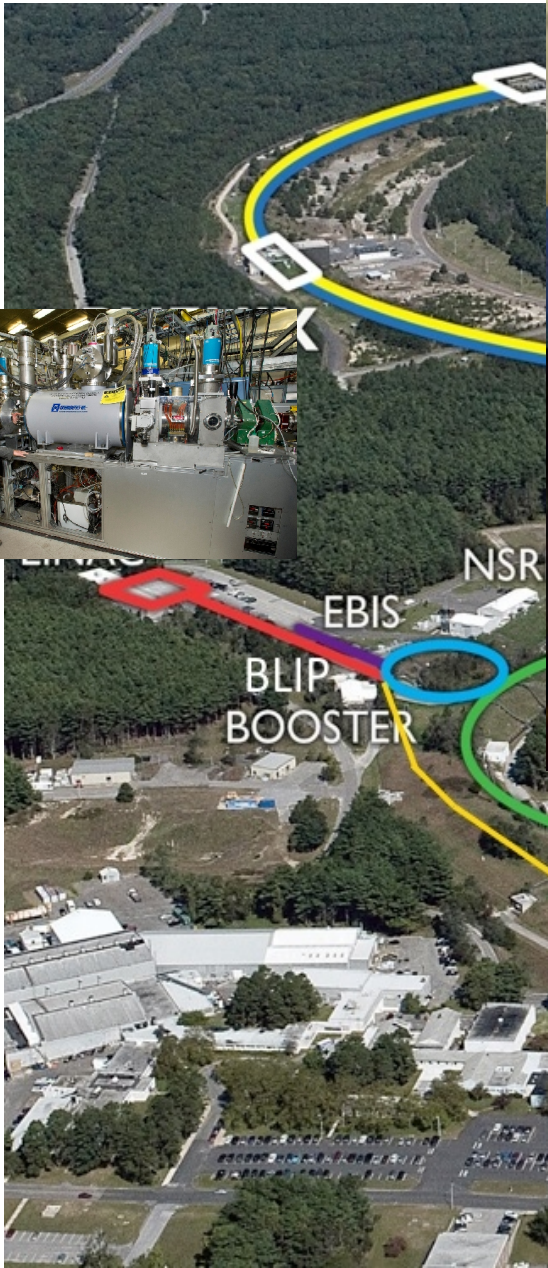

RHIC

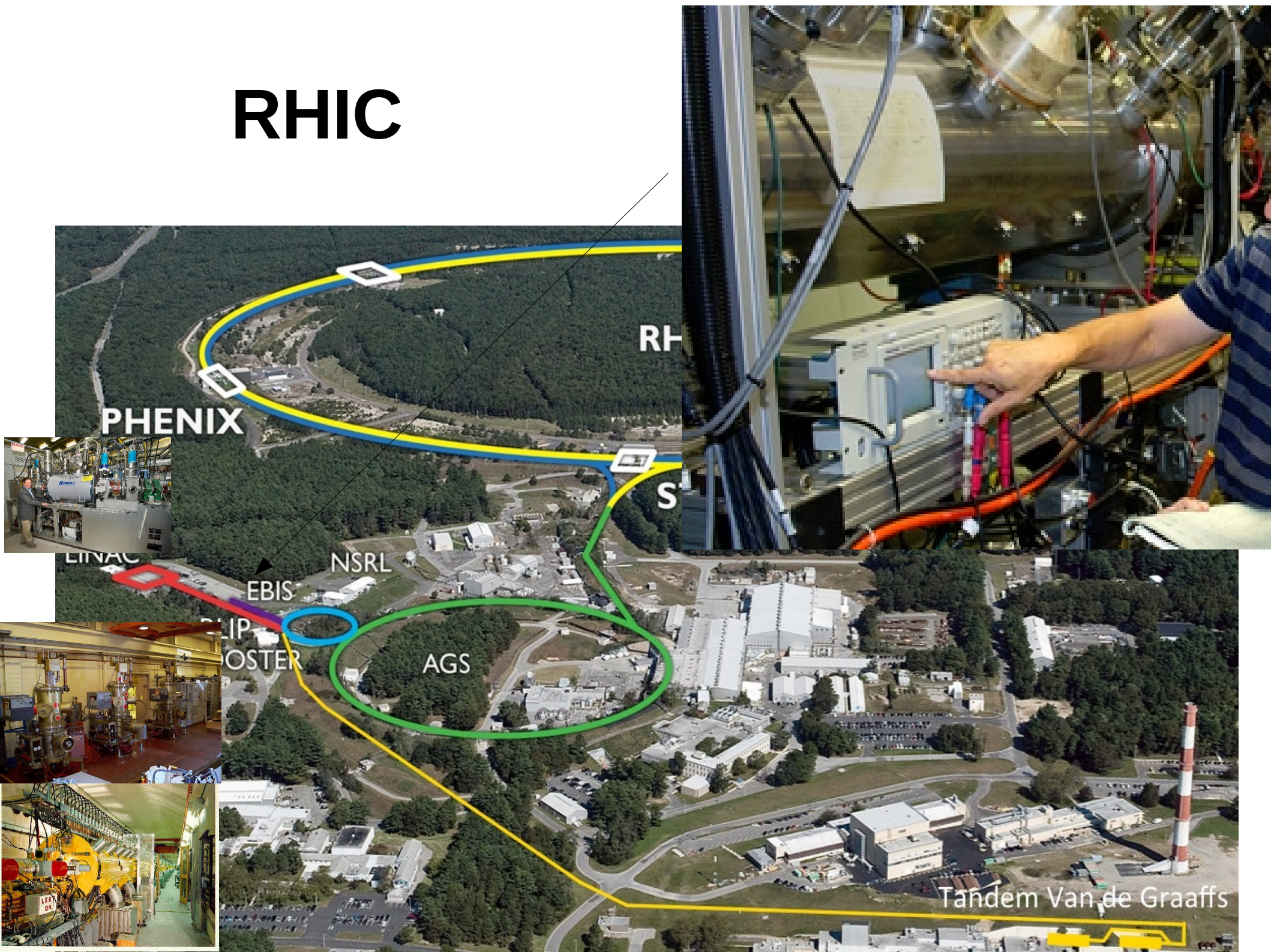

PHENIX

RHIC

S

LINAC

EBIS

NSRL

CLIP
BOOSTER

AGS

Tandem Van de Graaffs

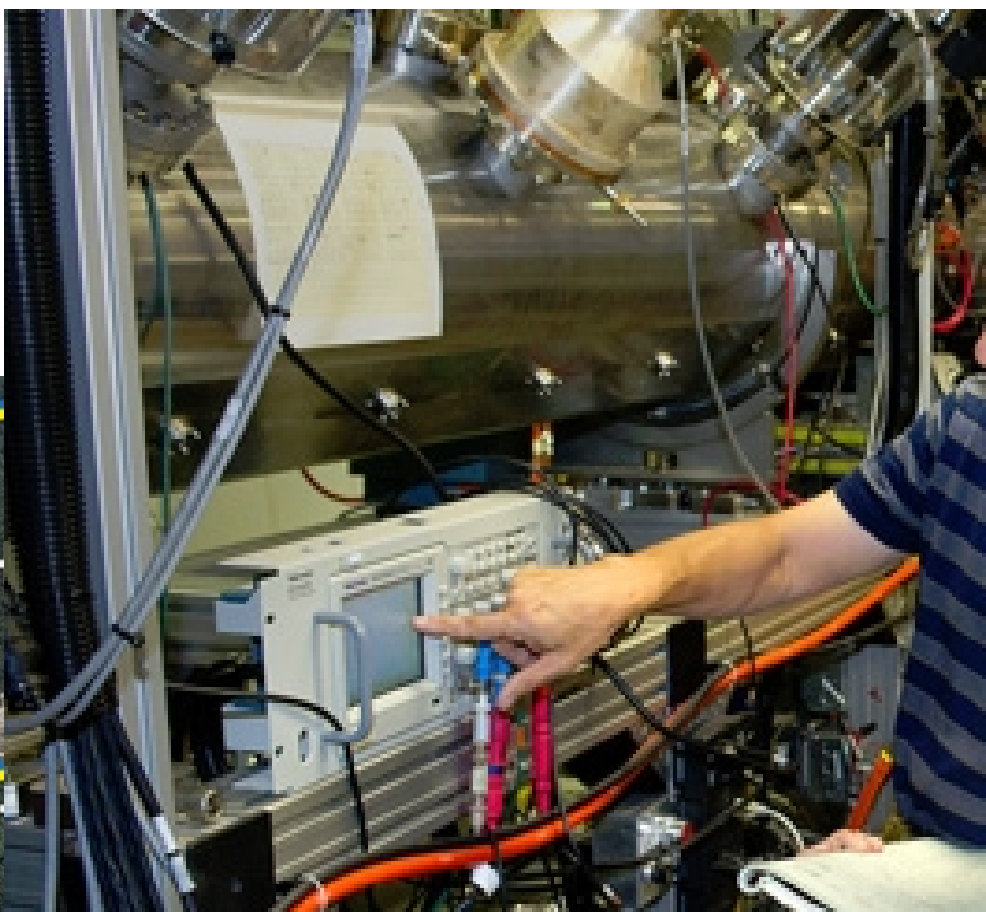
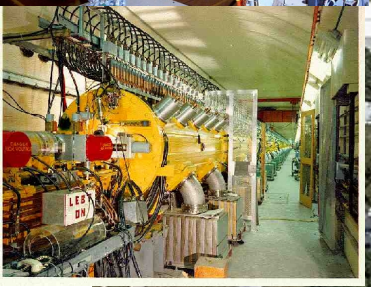

RHIC



Tandem Van de Graaffs

RHIC

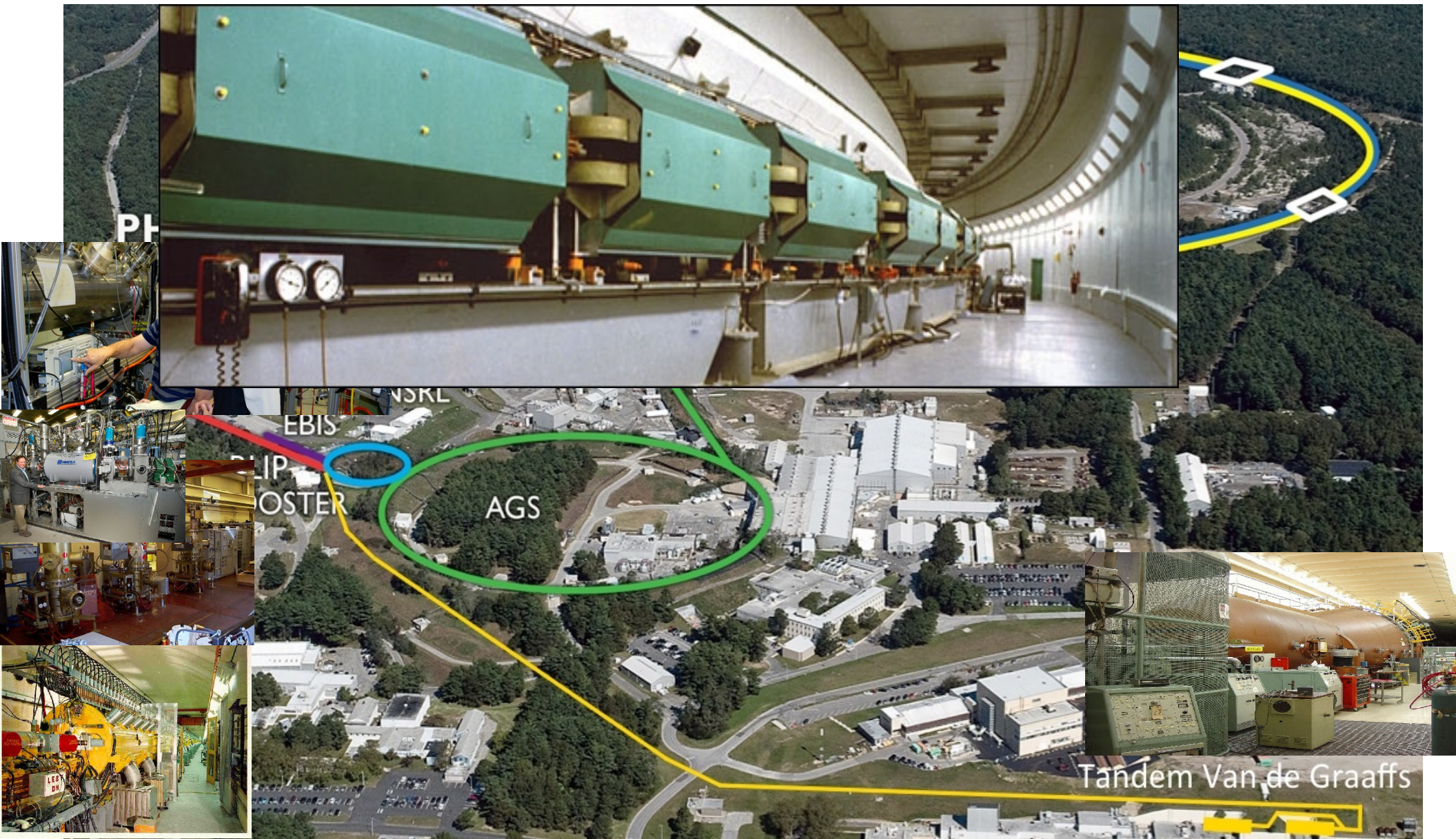

RHIC

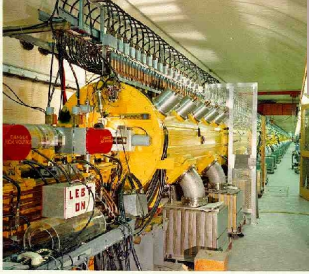
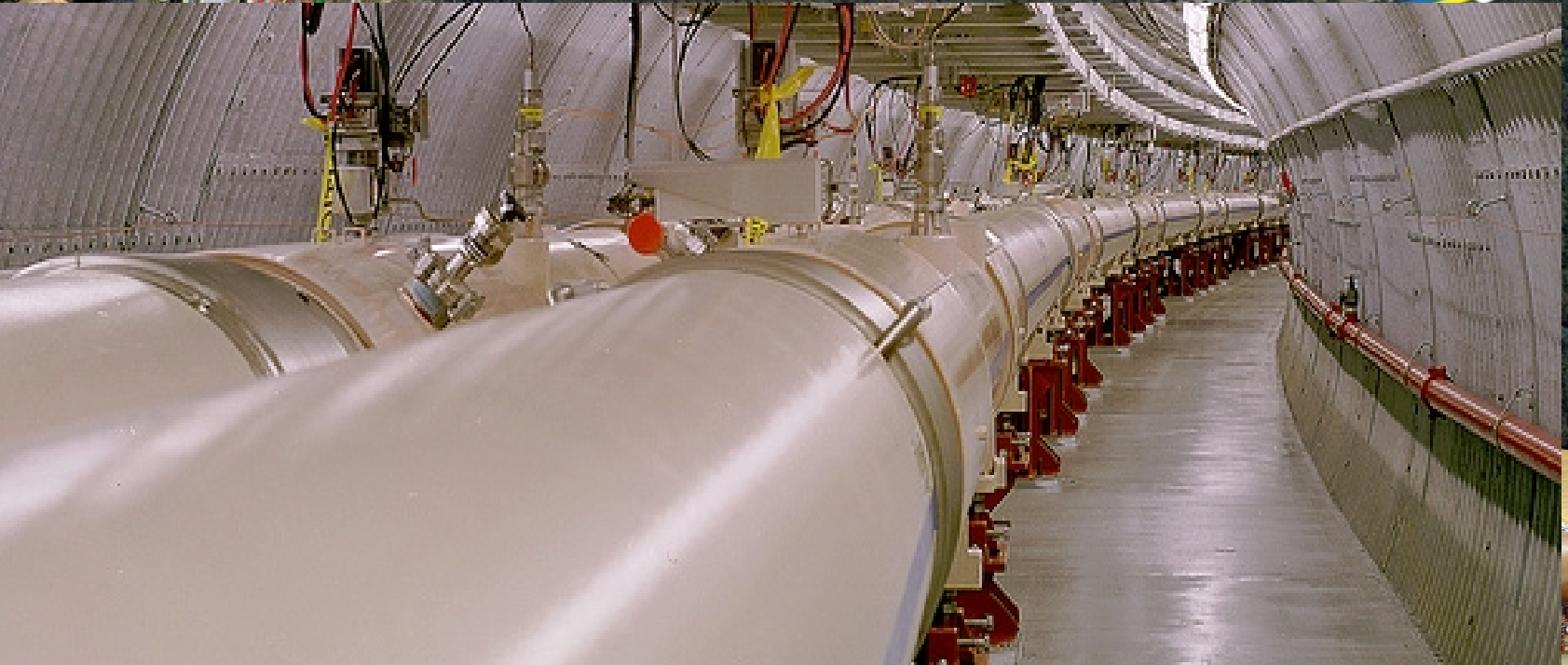

RHIC and AGS also house Siberian snakes

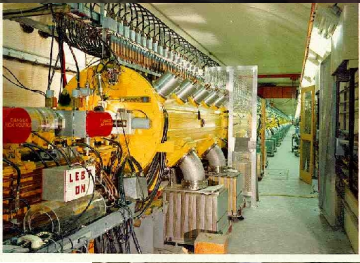
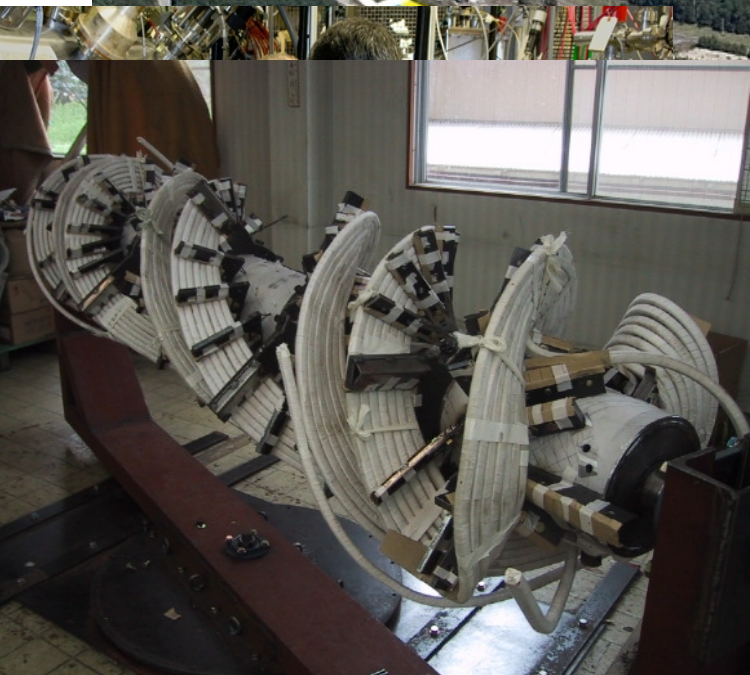
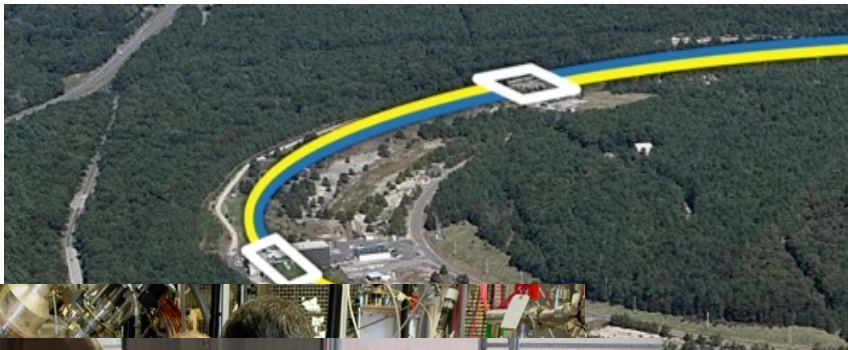
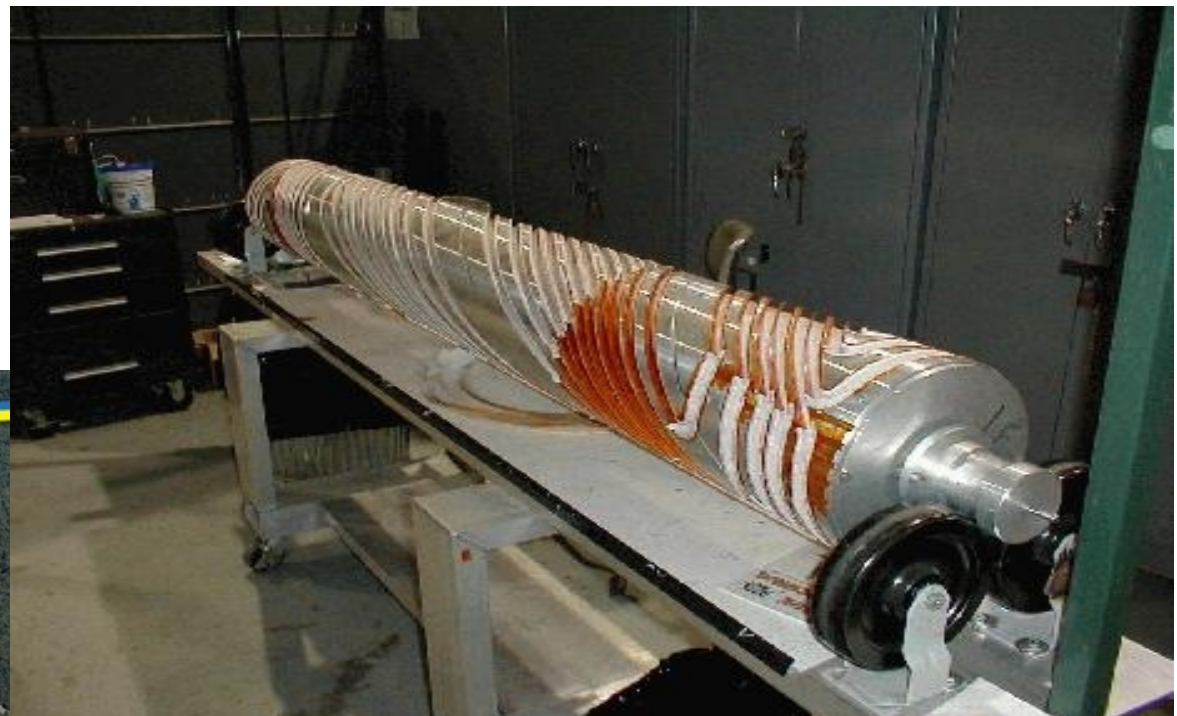

The quark-gluon plasma created at RHIC collision points

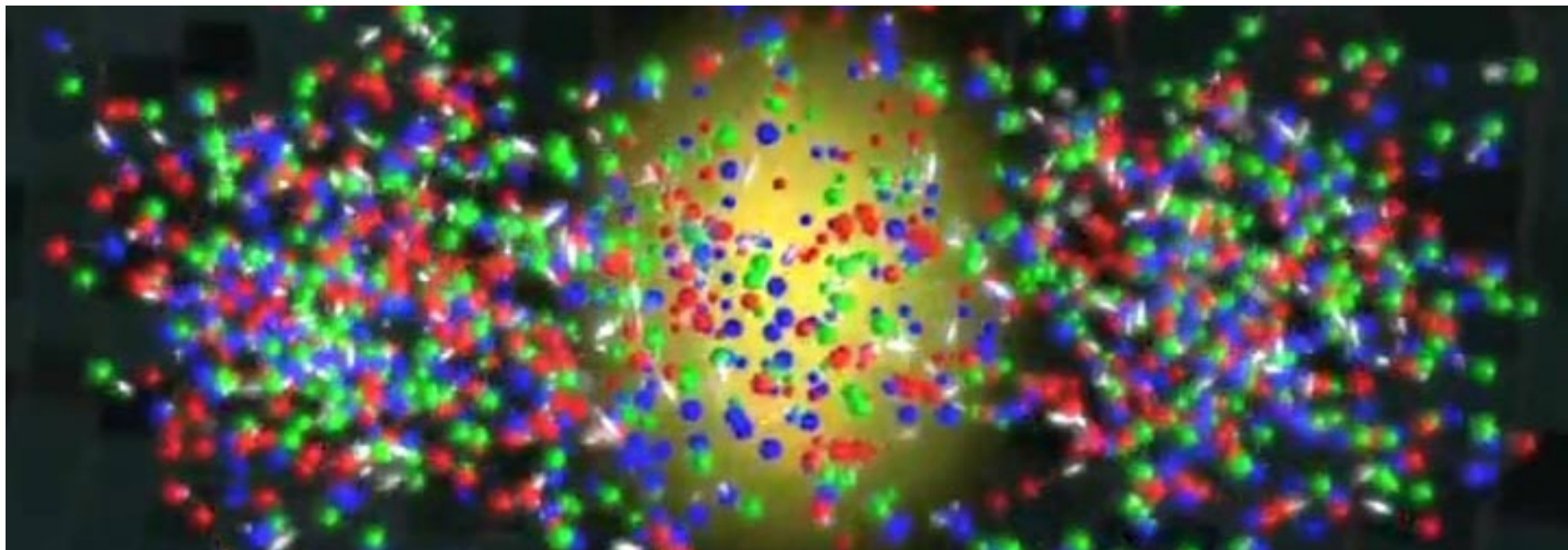
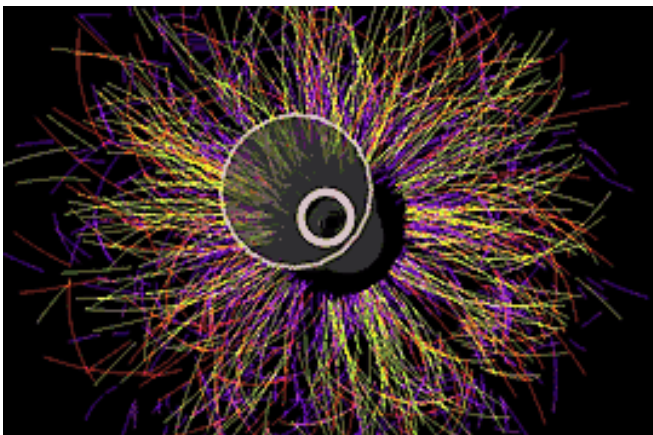

Would you believe that :

- **Machine availability >90% achieved !**
- **10 km of accelerator and beam lines,**
- **thousands of super-duper high-tech equipments !**

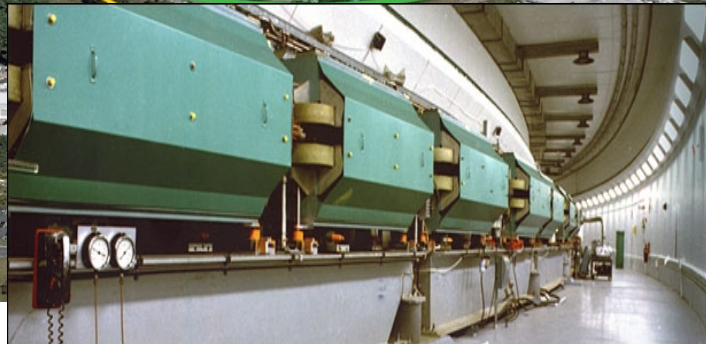
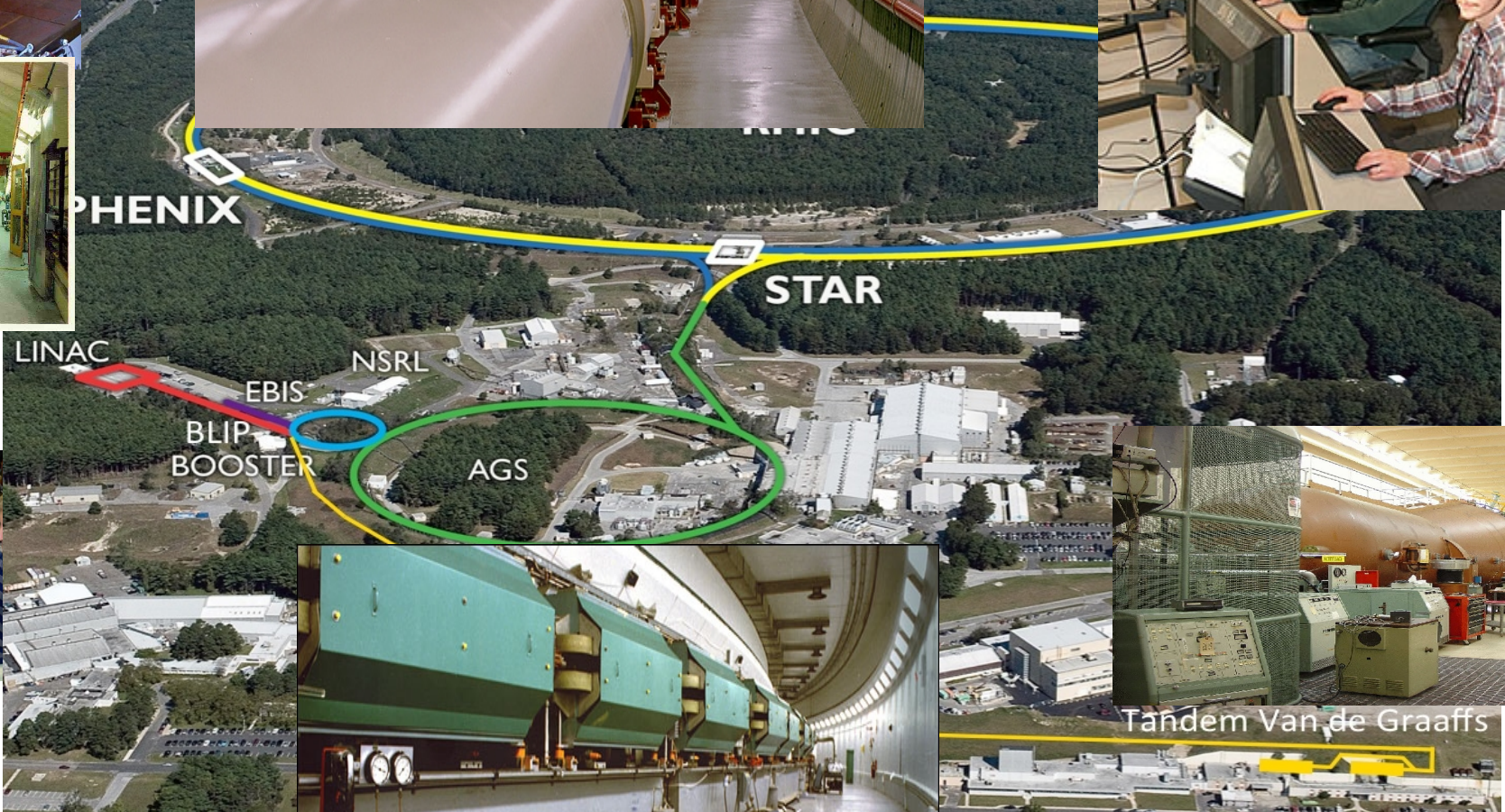
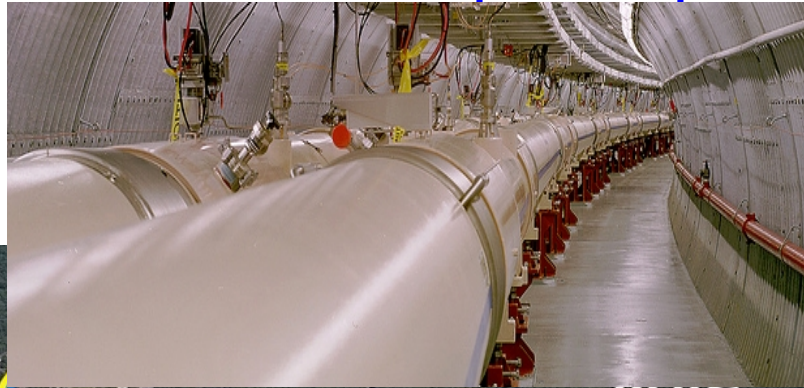
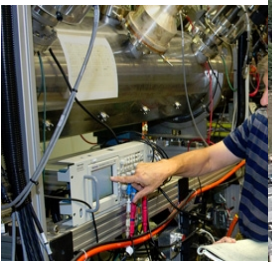
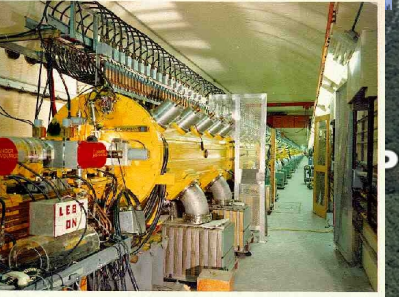

The largest collider: LHC

First run : 2009, energy first limited to 2×3.5 TeV
Discovery of Higgs Boson announced in 2012
Now operating at 2×6.5 TeV

10,000 people from 113
different countries
contributed



CERN's Accelerator Complex

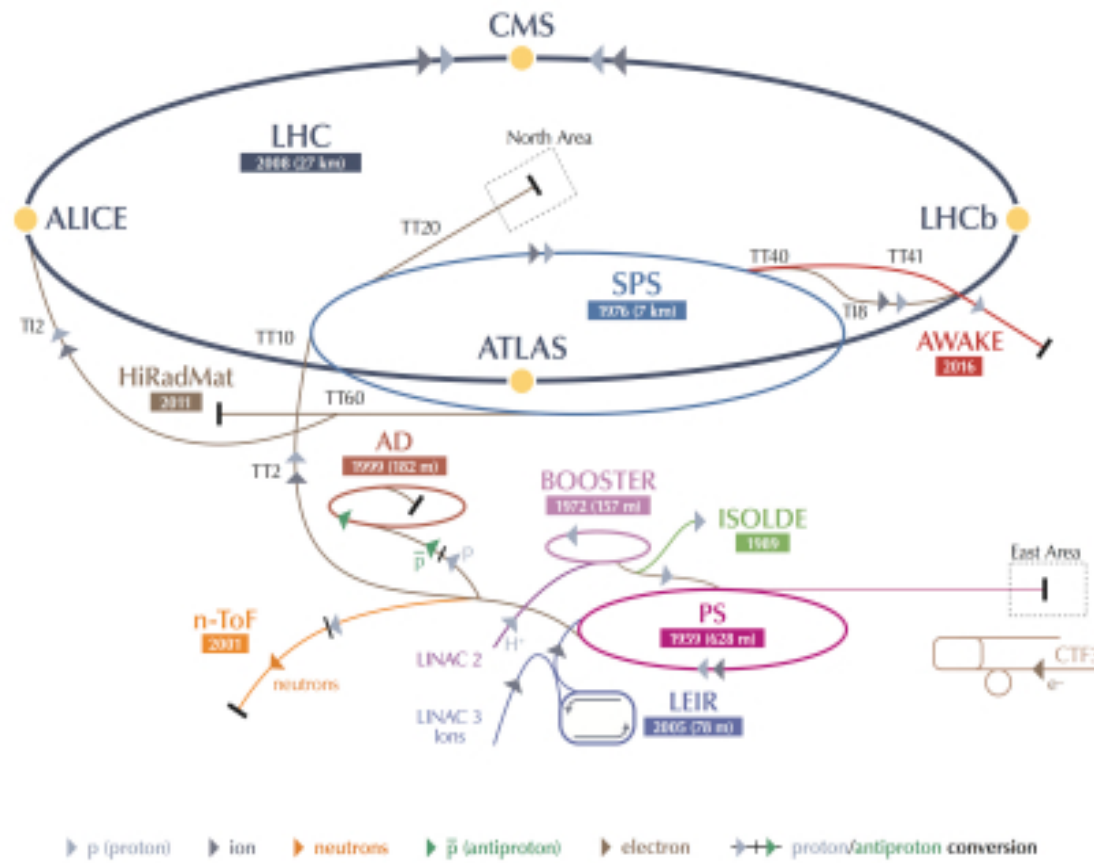

LHC Large Hadron Collider SPS Super Proton Synchrotron PS Proton Synchrotron

AD Antiproton Decelerator CTF3 Clic Test Facility AWAKE Advanced WAKEfield Experiment ISOLDE Isotope Separator OnLine DEvice

LEIR Low Energy Ion Ring LINAC LINear ACcelerator n-ToF Neutrons Time Of Flight HiRadMat High-Radiation to Materials

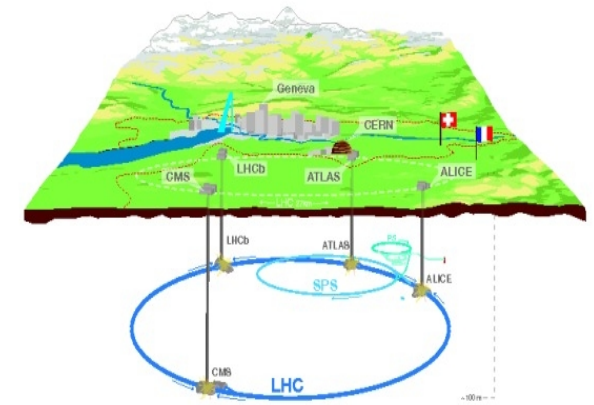

LHC DIPOLE : STANDARD CROSS-SECTION

CEBN AC 02/03/04 - PS 107 - 02/04 2000

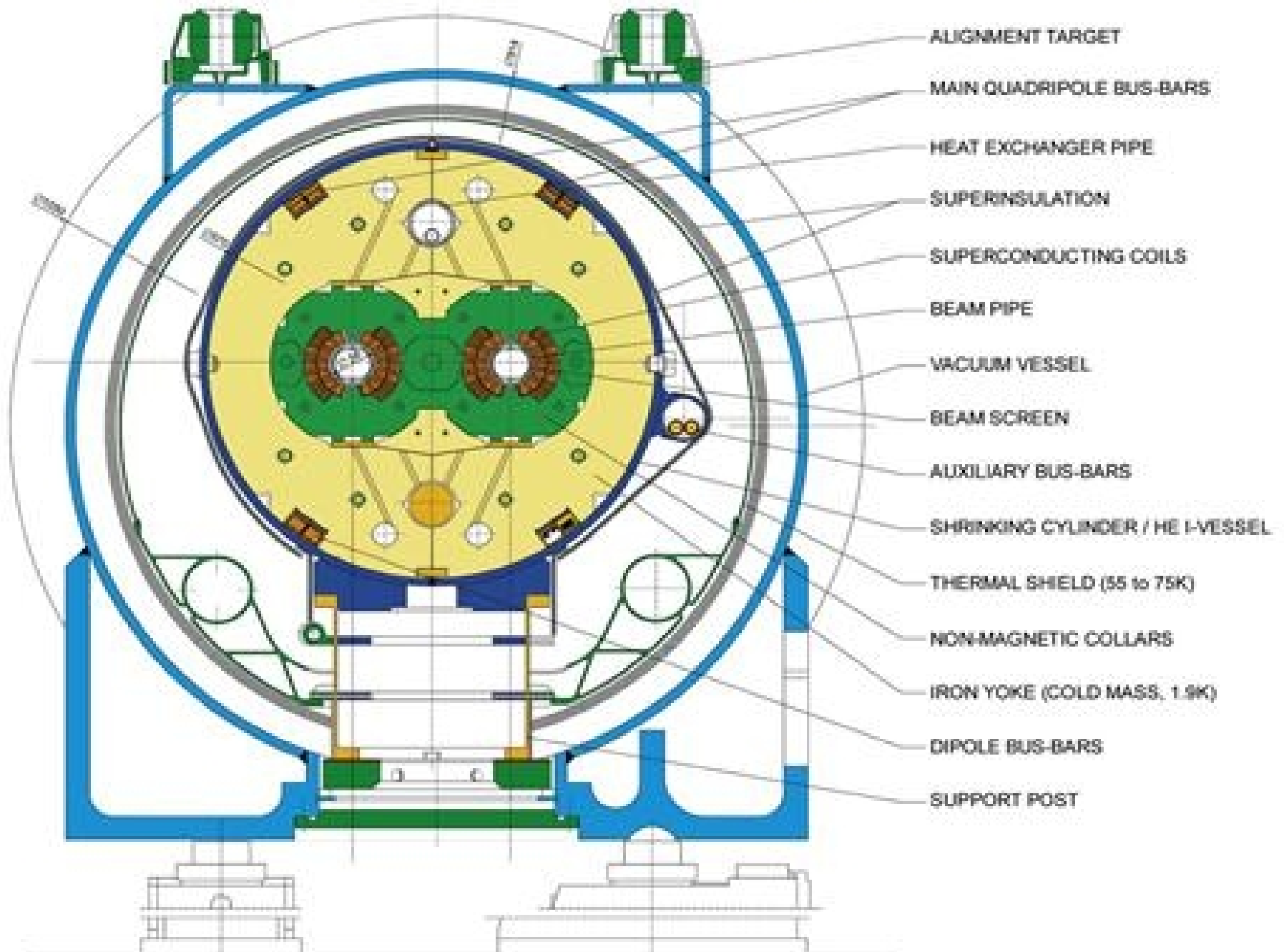



SUPERCONDUCTING CAVITIES

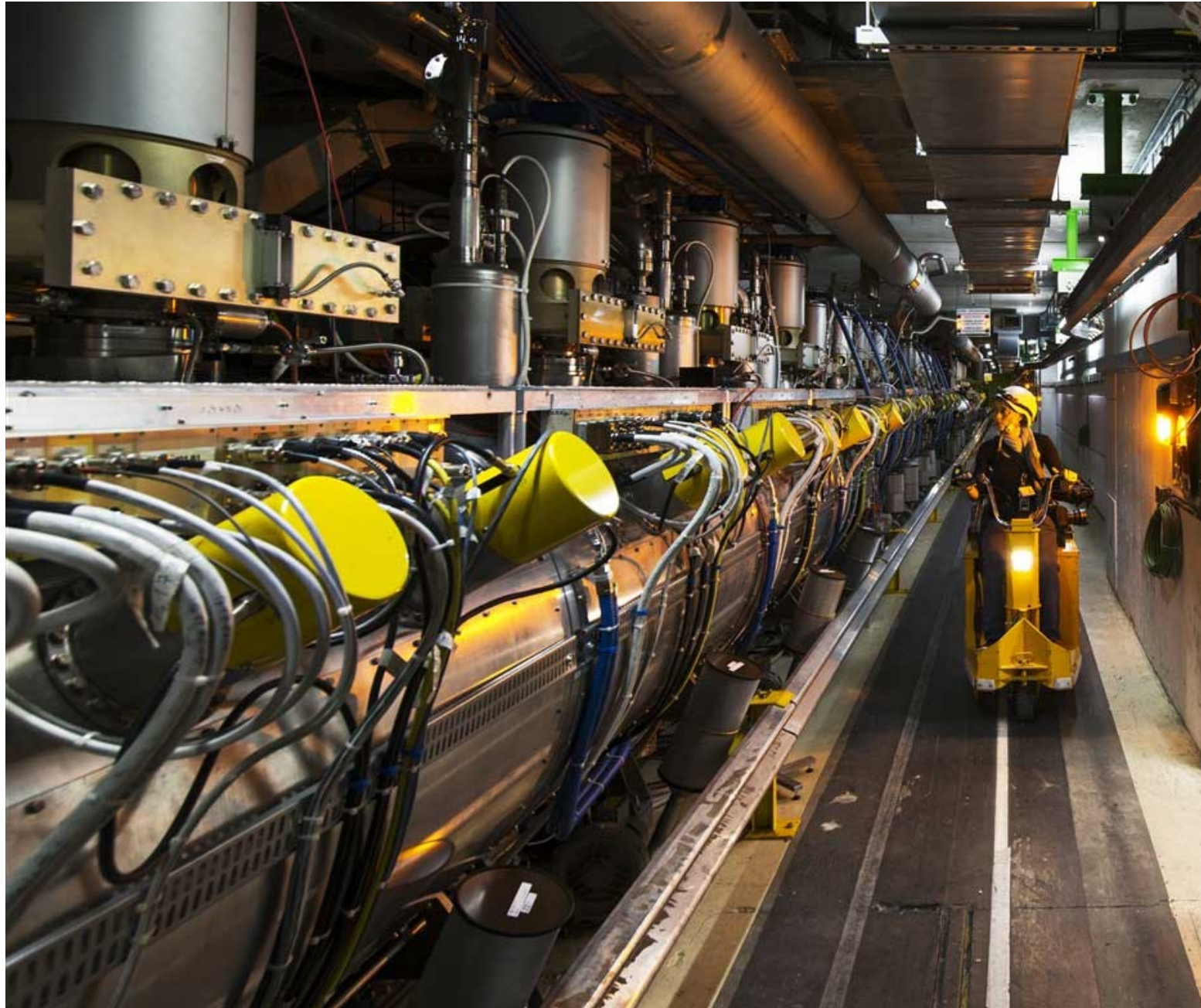



ATLAS

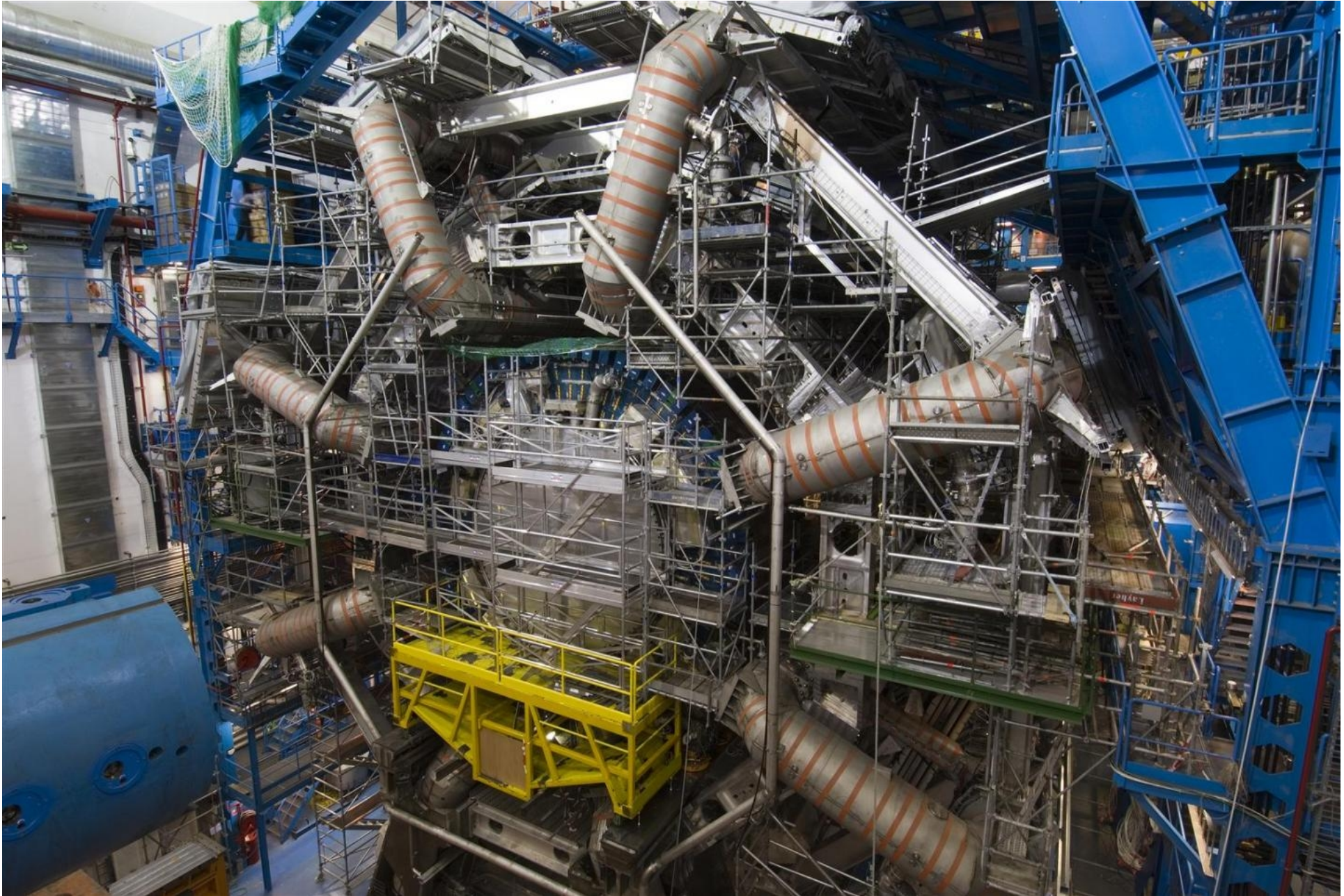

CMS

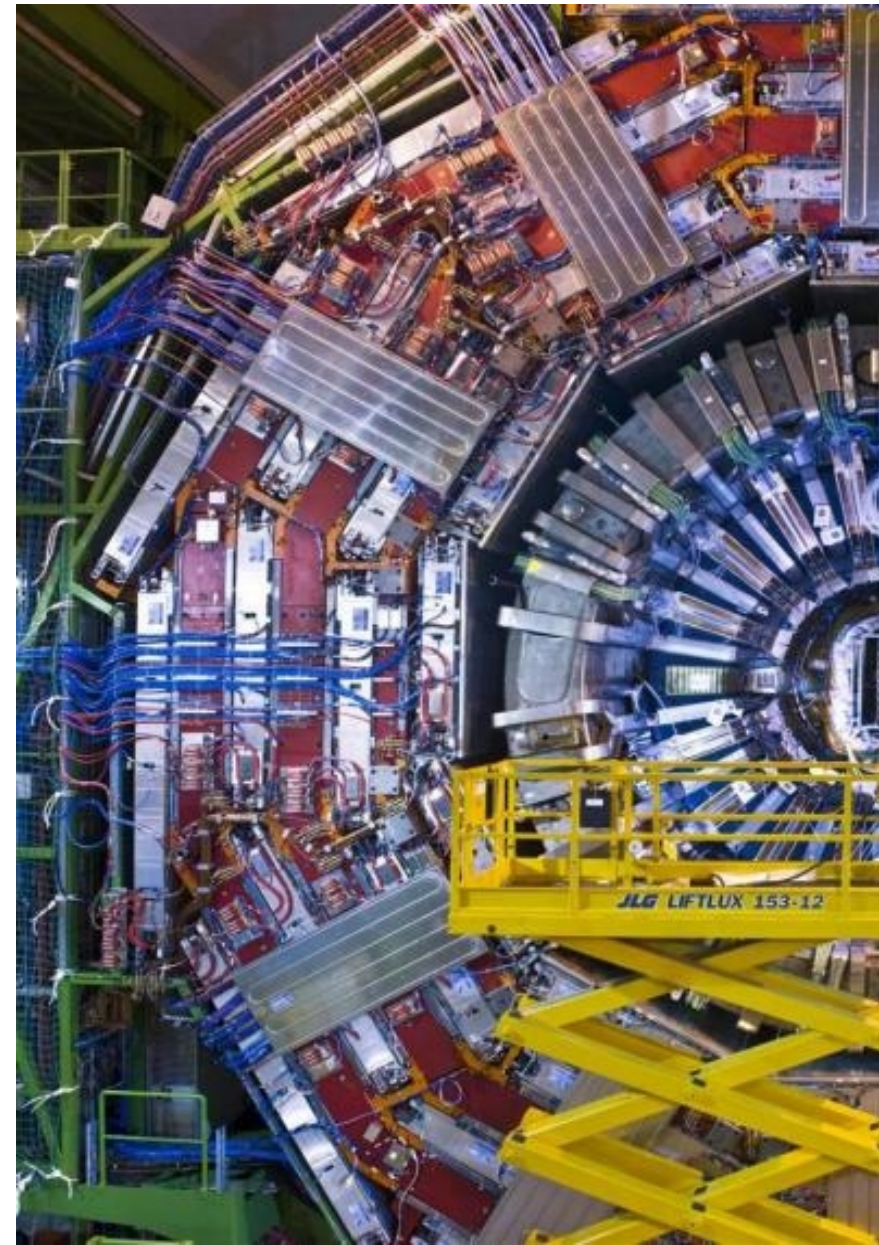

ACCELERATORS AND NOBEL PRIZES

(and there is more about “particle beams” in general)

- 2013 - François Englert and Peter W. Higgs, "for the theoretical discovery of a mechanism that contributes to our understanding of the origin of mass of subatomic particles, and which recently was confirmed through the discovery of the predicted fundamental particle, by the ATLAS and CMS experiments at CERN's Large Hadron Collider"
- 1995 - Martin L. Perl, Frederick Reines, "for pioneering experimental contributions to lepton physics". Respectively, "for the discovery of the tau lepton" and "for the detection of the neutrino"
- 1992 - Georges Charpak, "for his invention and development of particle detectors, in particular the multiwire proportional chamber"
- 1989 - Hans G. Dehmelt and Wolfgang Paul, "for the development of the ion trap technique"
- 1988 - Leon M. Lederman, Melvin Schwartz and Jack Steinberger, "for the neutrino beam method and the demonstration of the doublet structure of the leptons through the discovery of the muon neutrino"
- 1984 - Carlo Rubbia and Simon van der Meer, "for their decisive contributions to the large project, which led to the discovery of the field particles W and Z, communicators of weak interaction"
- 1976 - Burton Richter and Samuel Chao Chung Ting, "for their pioneering work in the discovery of a heavy elementary particle of a new kind"
- 1968 - Luis Walter Alvarez, "for his decisive contributions to elementary particle physics, in particular the discovery of a large number of resonance states, made possible through his development of the technique of using hydrogen bubble chamber and data analysis"
-
- 1905 - Philipp Lenard : His research on cathode rays
- 1906 - J J Thomson : Discovery of the electron
-