

*You enjoyed Terminator ... Predator ... Gladiator ?  
You'll fall for*

# *ACCELERATOR*

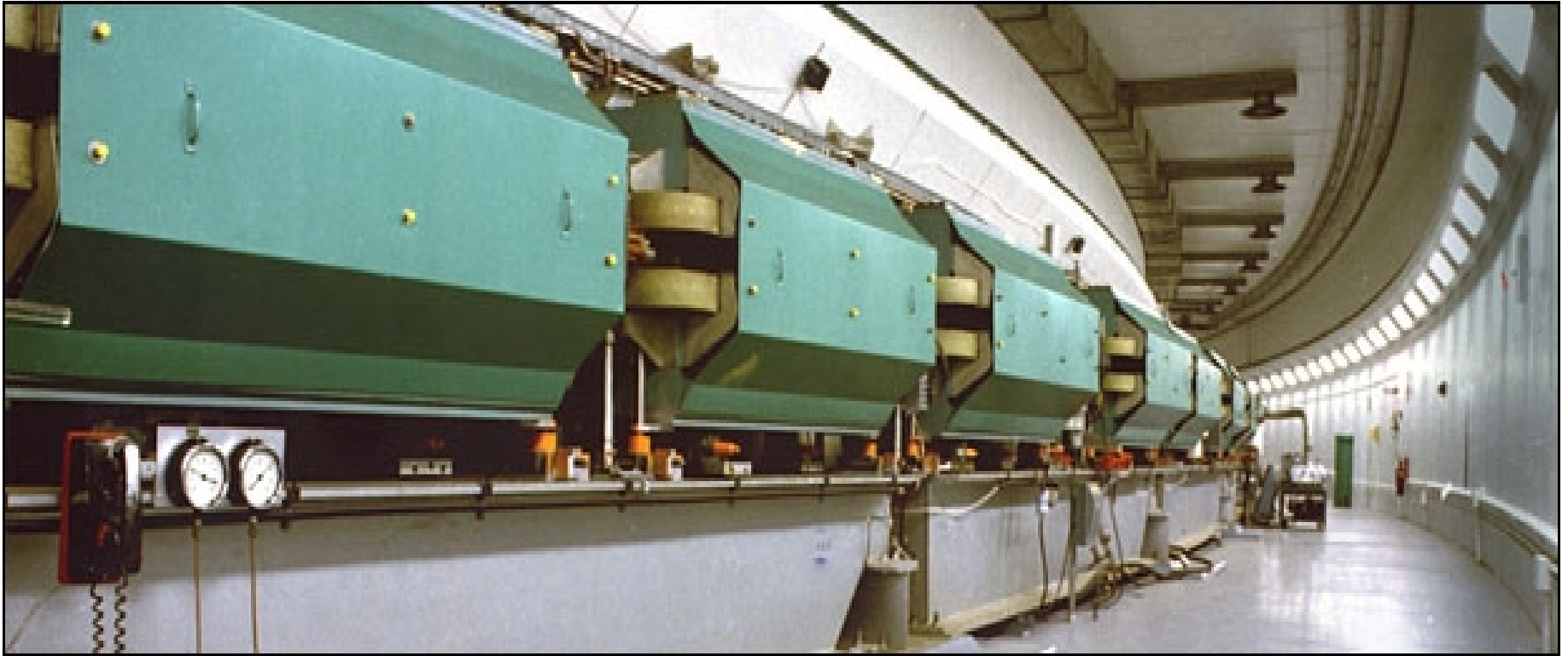

- **Charged particle accelerators have thrived over a century, they are nowadays – we live terrific times ! engines of discovery in many areas of life, matter, energy science, they have accessed a forefront place in scientific research, industry and societal applications**
- **Depending who uses them, they are known under names as “atom smasher”, “light source”, “spallation neutron source”, “neutrino factory”, “collider”, “hadrontherapy ring” and a plethora of others – as varied as their applications are varied**

**This “tour of the accelerator planet”, casts a glance at the origin of these modern, ultra-high-tech instruments, at today's state-of-the-art, and in some cases at where they are heading for...**

## **This “tour” is organized in the following way**

- **Major accelerator styles are introduced following the order they entered History, namely**
  - **Linear accelerator**
  - **Cyclotron family**
  - **Betatron**
  - **Synchrotron**
- **For each style,**
  - **First, a couple of examples of the state-of-the-art are discussed**
  - **Then the principles – including a small amount of theory and basic technological concepts – are discussed**

**We'll just keep the following in mind, in addition, since it gives an understanding of the evolutions, and of preferred technology depending on the application:**

## **Accelerators are “particle factories”**

- **They are fabricated for producing intense or very energetic beams of particles, charged or not :**

**ions of all sorts, radioactive or not, neutrons, cosmic type of particles, neutrinos, photons, etc.,**

- **for a number of researches and applications :**

**search for missing mass, supersymmetries, cosmology, condensed matter, radio-biology, cancer treatment, X-lasers, oodles of industrial applications, weapons, etc**



# **LINEAR ACCELERATORS**

**\* Let's first consider neutron production \***  
**This is where we are today (1/2)**

**SNS, Oak Ridge**



**ESS, Lund, Sweden**



# spallation NEUTRONS

- Flux, in modern research reactors, typically:  $10^{15}$  /cm<sup>2</sup>/s
- From spallation sources, i.e., accelerators :  $10^{17}$  /cm<sup>2</sup>/s

*A greater flux reduces the time required to conduct an experiment.*

(Similar leap in many other sectors, e.g., photons from X-ray tubes versus light sources)

- The two technologies, reactor and accelerator, compete today.

*Drawback of the reactor method : requires highly enriched U235, 20%, in some cases “weapon grade” EU, 93% U235.*

*There are programs to switch to LEU, though... that's another story !*



**SNS, operates since 2006,  
the largest, highest power, *linear*, proton accelerator in the world**

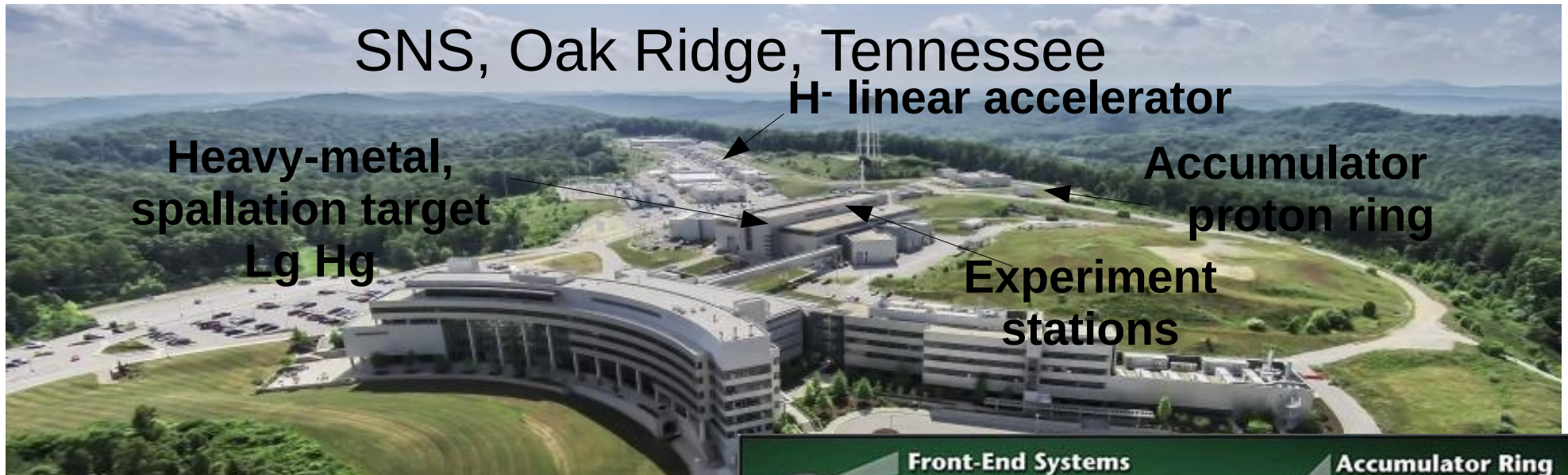

Commissioning		2006
SCL linac length	m	180
Kinetic energy	GeV	1
Beam power	MW	1.4
Repetition rate	Hz	60
Duty factor (Df)	%	6
Peak current (Ip)	mA	38
Average current	mA	1.6
Ring accumulation	turns	1060
Ring peak current	A	25
Ring bunch population	ppp	$1.5 \cdot 10^{14}$
Pulse length at target	$\mu\text{s}$	0.7



$$I = Qf = \text{ppp} * e / (C/c)$$



# SNS

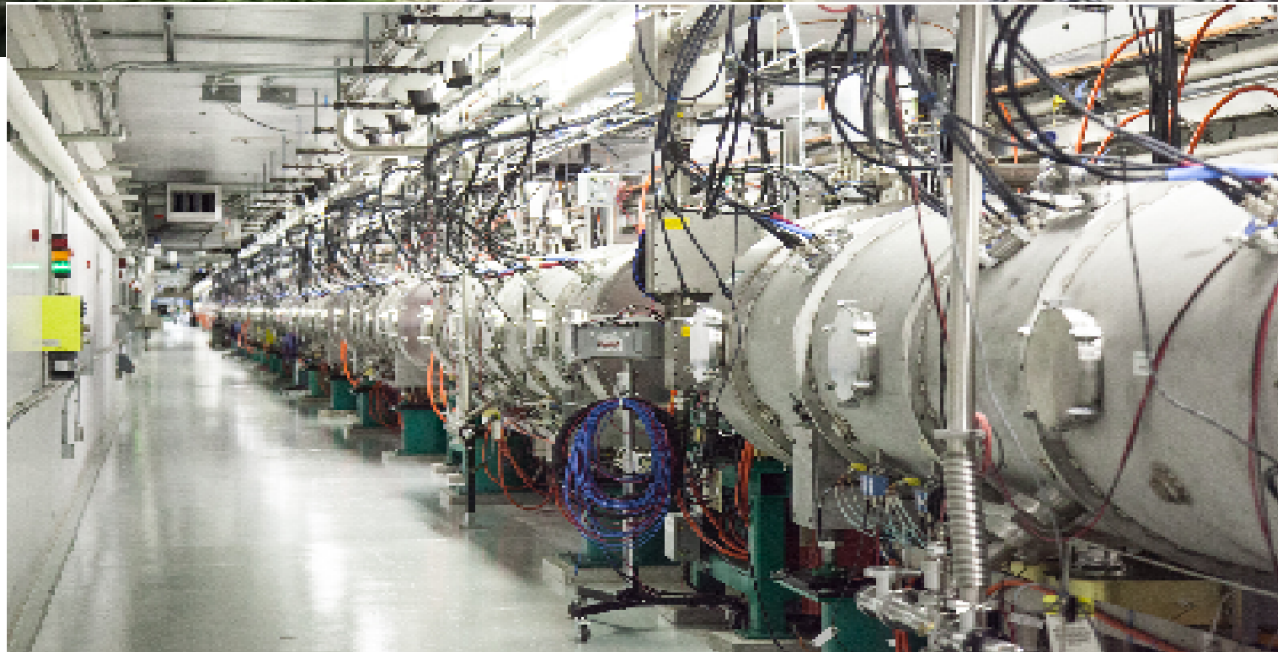

# *ESS, currently under construction, in Lund, Sweden, will be the world most powerful neutron source*

Linac length, overall	m		
Kinetic energy	GeV	2	proton
Beam power	MW	5	
Repetition rate	Hz	14	
Duty factor (Df)	%	4	
Pulse current (I <sub>p</sub> )	mA	62.5	
Average current	mA	2.5	I <sub>p</sub> x Df ~ 38[mA] x 6[%]
Pulse length at target	ms	2.86	

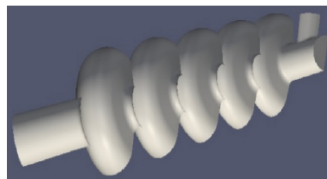
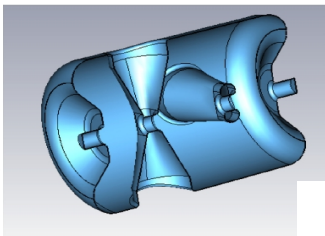
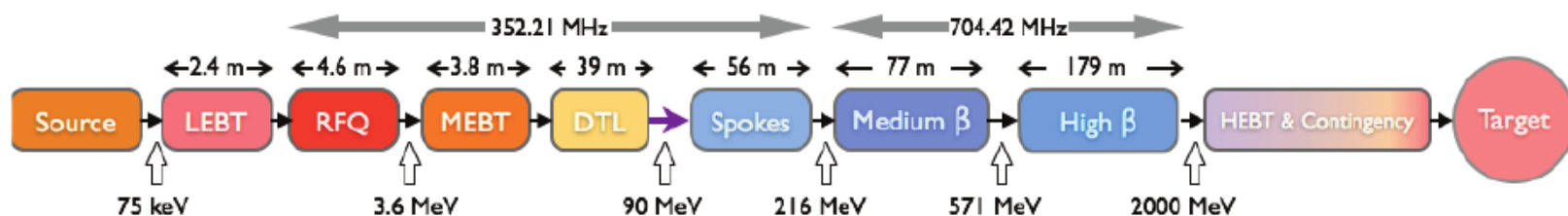

Figure 4: High  $\beta$  elliptical cavity proposed for ESS.



# A tremendous complexity

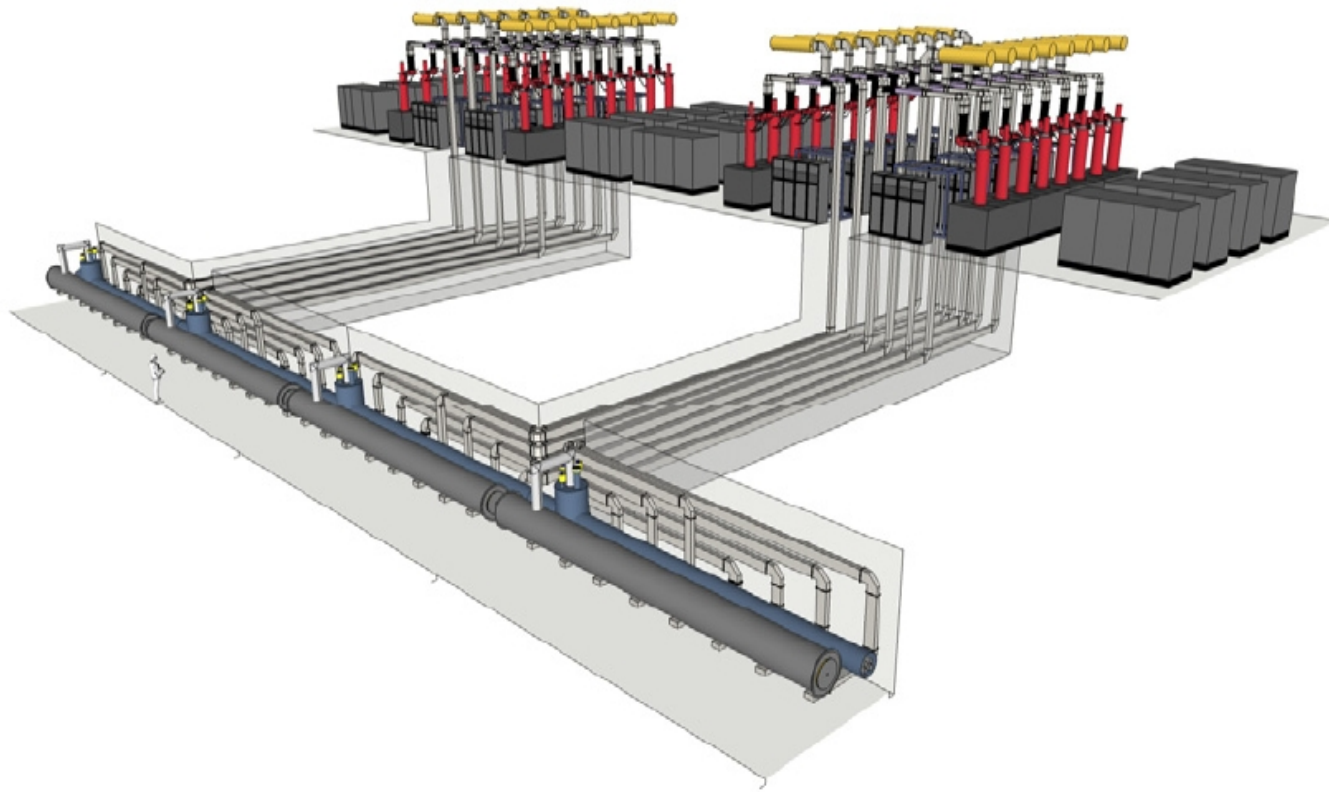
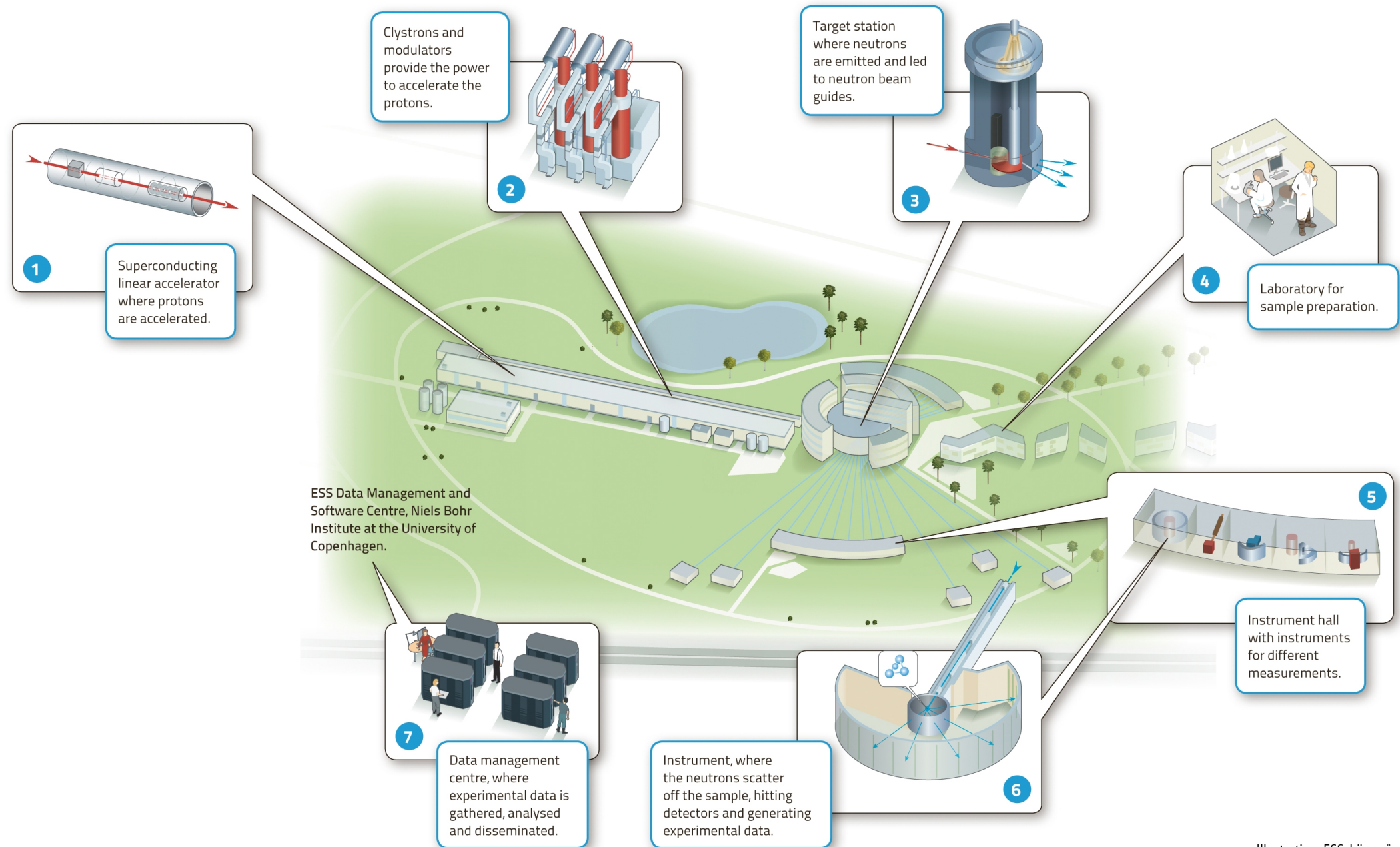

Figure 4: Layout of RF gallery (top right) and linac tunnel (bottom left) with waveguides between klystrons and cryomodules.



# How is an sns organized ?





- A spallation neutron source provides the most intense pulsed neutron beams, for scientific research and industrial development.

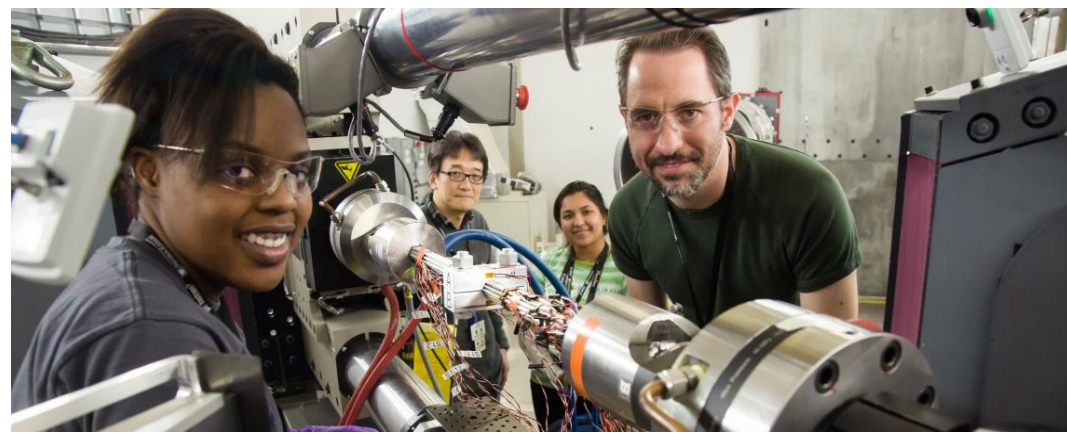

- Researches cover a broad range of disciplines, such as physics, chemistry, materials science, biology. Neutron scattering community performs there measurements of greater sensitivity, higher speed, higher resolution, and in more complex sample environments than have been possible at existing neutron facilities.

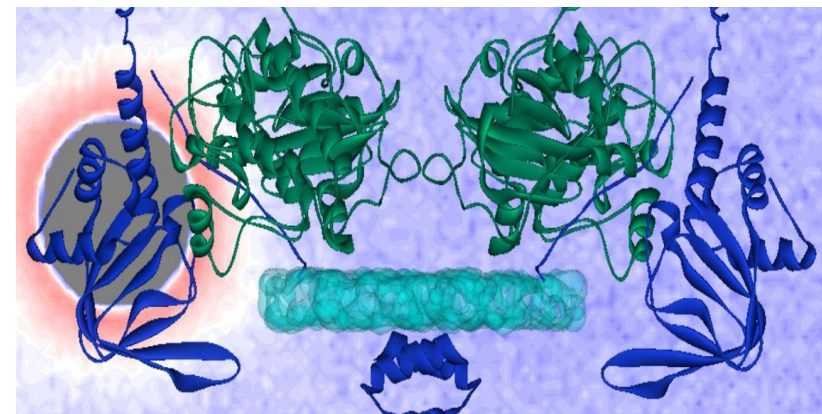

A neutron source and its complementary detection instruments can be compared with a giant microscope for the study of materials – from plastics and pharmaceuticals, to engines, and molecules.

# Linear accelerators... where they come from, how they were made to work

## 1 Generalities

- Particle accelerators were born in the quest of “atom smashers”, in a context of needs for higher and higher energies, beyond natural radioactivity bodies, in the several MeV range :  
for producing high energy  $e^-$  and ion beams, probing the atomic nucleus, creating new elements and isotopes

For reference : high energy alpha from radioactive particles were  $\sim 10$  MeV.

- In the era of nuclear R&D, civil and military, they allow(ed) extensive production of data on radio-isotopes, production cross-sections...
- Very high energies have opened the field of accelerator based particle physics
- Energies have increased exponentially over the years, more or less saturating depending on the technology
- Later, with discoveries as synchrotron radiation, hadron-therapy, and given their potential for number of applications, accelerators found themselves predilection tools in many domains of science : production of X-rays, medical, industry...

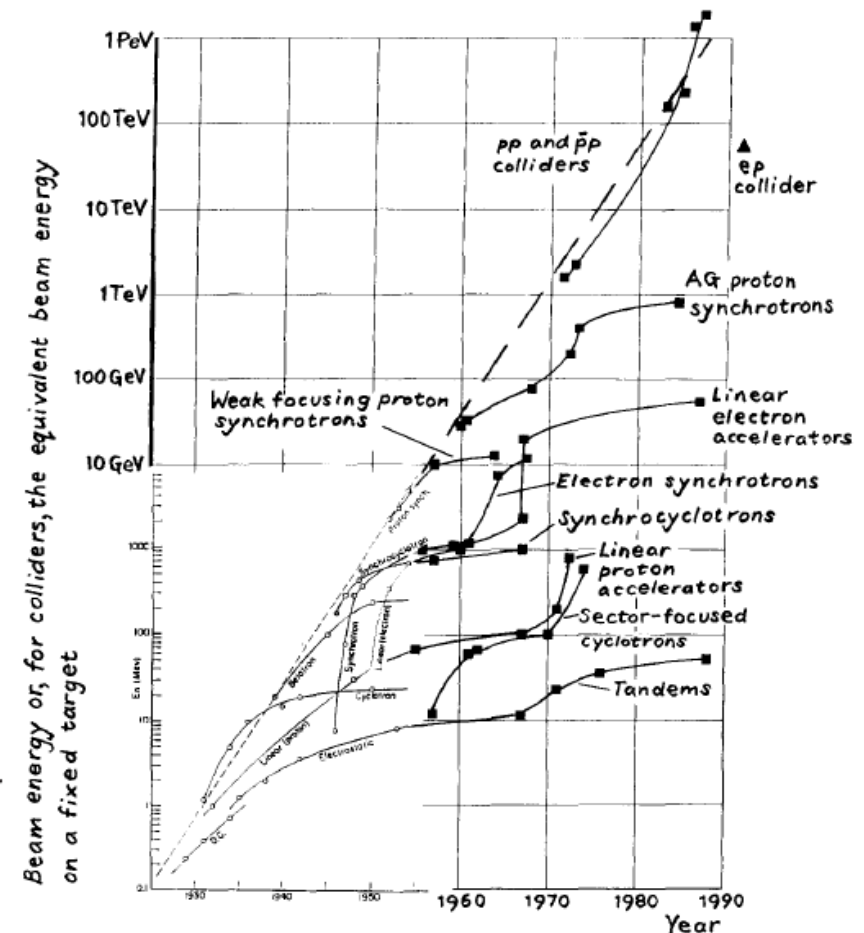

## 2 Prehistory

### $\alpha$ particles were the first projectiles

- 1900s Rutherford figures out that  $\alpha$ -particles are He nuclei.
- 1910 Rutherford and Madsen first smash atoms with  $\alpha$ -particles to gain insight in the atom structure from scattering patterns. They detect the presence of a nucleus.
- 1910s Rutherford and Madsen kick out protons from various elements by that very method
- 1930s Bothe and Becker, Joliot-Curie family, Chadwick knock out neutrons by bombarding Be nuclei :  $\alpha + {}^9\text{Be} \longrightarrow {}^{13}\text{C} + n$ .

Chadwick convincingly shows that the emerging particles were neutrons.

### Cosmic rays

- 1900s, Presence of radiation observed, using electroscopes and electrometers, even away from any radioactive source.
- 1932 Anderson discovers positron, predicted by Dirac
- 1937 Anderson and Neddermeyer discover a particle with  $220\times$  the electron mass, from cosmic ray snaps: the muon
- 1947 Lattes, Occhialini, Powell discover charged pions (today's  $\bar{u}d$  and  $\bar{d}u$  quark pairs)
- 1940s Discoveries of strange particles:  $K^\pm, K_0, \Lambda, \Sigma^+$  (hadrons with one strange quark)

- The difficulty of these paths was that one had no control over the projectiles, their energies, their rate was rather scarce
- Hence the interest of accelerators for creating new particles. Milliampers of MeV particles from accelerators is equivalent to thousand-Curie radioactivity.



### 3 Electrostatic accelerators

#### A BRIEF INTRODUCTION

- Creating strong electrostatic potential : simplest and most obvious method.  
This is a way to communicate energy to charged particles, by virtue of

$$\vec{F} = -q \text{grad}V, \quad W = qV$$

- There was a broad context of development of high voltage generators :
  - Whimshurst wheel (1880s - 10s kV, few tens  $\mu\text{Amp}$ ), Marx generator (1924 - a variant of a voltage-multiplier), Tesla coil (induction high voltage) ...
  - Two methods succeeded : Cockcroft-Walton voltage multiplier, Van de Graaff electrostatic generator.
- Limitation on potential achievable for particle acceleration resides in
  - ohmic losses in apparatus structure - proportional to potential
  - current from ionized gas - limited by saturation
  - corona discharge - the major cause



## Cockcroft-Walton (1/3)

- A particular type of “voltage multiplier” (also known as “Greinacher multiplier”, earlier proposed by Heinrich Greinacher, Swiss, 1919), coupled to accelerating gaps, at Cavendish Lab., 1932 :
- interest of *accelerator method* proven by allowing first artificial nuclear transmutation,  ${}^7_3\text{Li} + p \longrightarrow 2 \times \alpha + 17 \text{ MeV}$
- Only 20 years later, 1951, did they get the Nobel prize “for their pioneer work on the transmutation of atomic nuclei by artificially accelerated atomic particles”.

John Douglas Cockcroft  
Ernest Walton

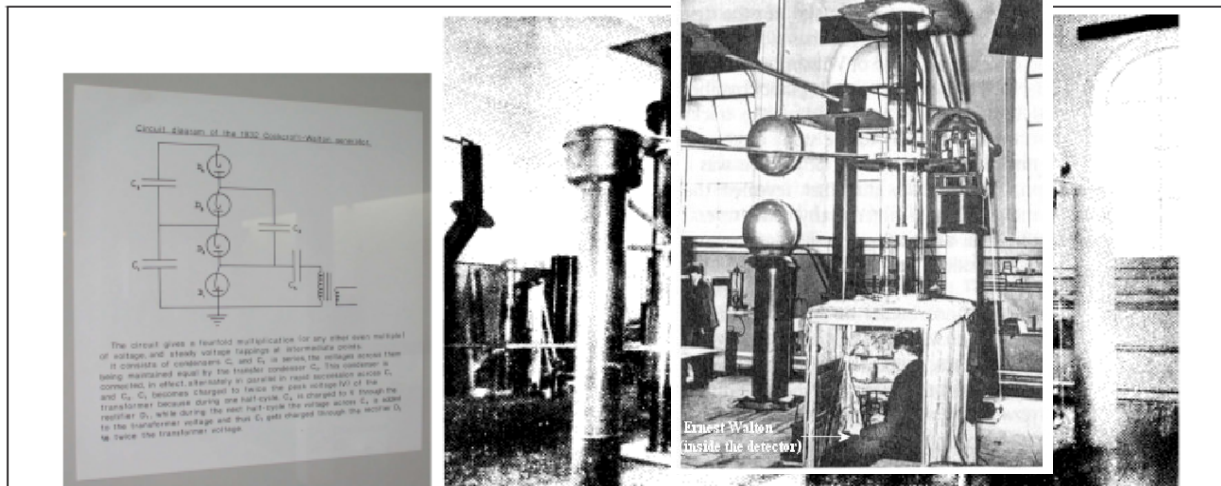
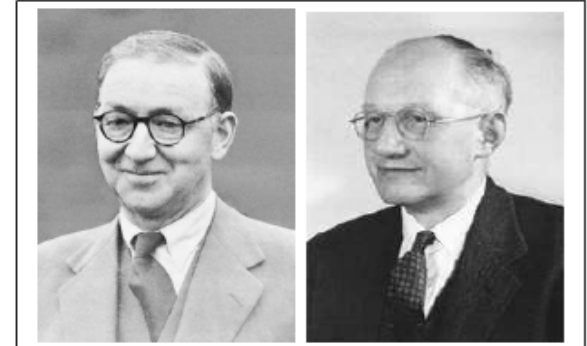

Voltage-multiplier circuitry and installation.

$\gtrsim 700 \text{ kV}$  from a 200 kV transformer were obtained,  
 $\sim 10 \mu\text{A}$  proton beam.

Penetration probability  $1.8 \cdot 10^{-7}$  at 700 kV  $\xrightarrow{10 \mu\text{A}}$   $10^7$  events/s.

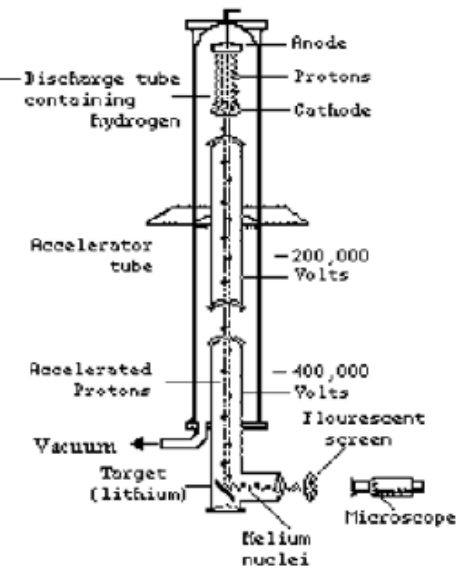

A scheme of C-W's 2-gap  
accelerator column.  
Potential for Li decay experiment  
was  $\sim 700 \text{ kV}$

## Cockcroft-Walton (2/3), principle

The figure below shows principle assembly of (modern-style) Cockcroft-Walton voltage multiplier driven by AC voltage supply (left) and typical multi-electrode accelerator column (right).

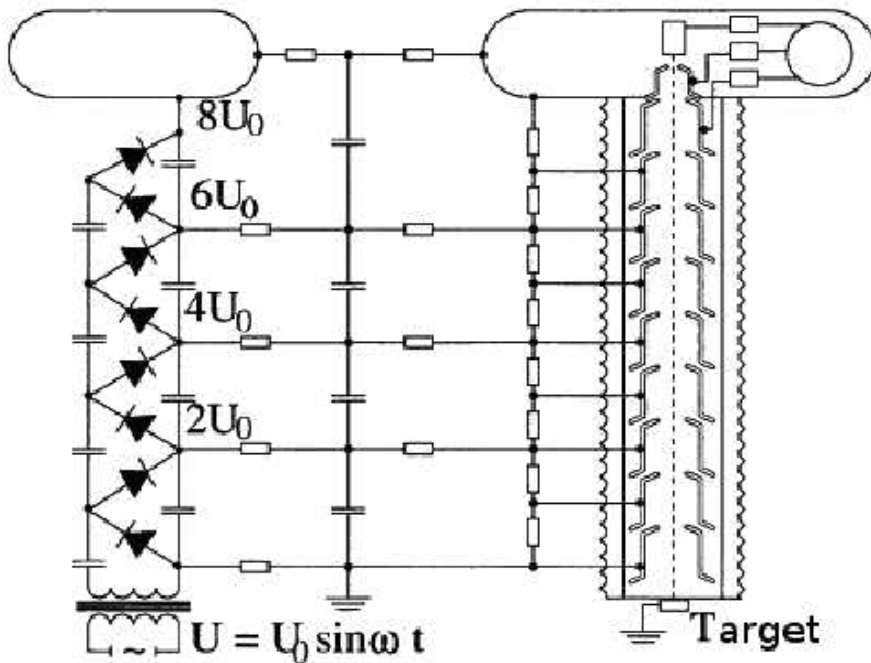

Nowadays technologies allow up to  $U_{total} \sim 5$  MVolts, several tens mA DC (>100 kW beam).

Principles :

The maximum voltage is  $2 \times n \times U_0$ , plus a correction for current induced loss :

$$U_{total} = 2 \times n \times U_0 - \frac{2\pi I}{\omega C} \times f(n)$$

$C$  = value of a capacitor

$n$  = number of stages

$I$  = ohmic loss + beam

$f \sim n^3$  polynomial dependence  $\Rightarrow$  limitation on  $n$  : voltage drop with  $I$  grows fast with the number of stages

It shows that large  $C$  and large  $\omega$  reduce the effect of  $I$  on  $U_{total}$ .

Accelerator application : stability  $\frac{\delta U_{tot}}{U_{tot}} \approx \frac{2\pi n^3}{RC\omega} \approx \text{few}\%$

Focusing : "cylindrical lens" principles

**Exercise :**

Take impedance  $R \sim G\Omega$ , capacity  $C \sim nF$ .

What is the order of magnitude of generator frequency  $\omega/2\pi$  for  $\frac{\delta U_{tot}}{U_{tot}} \sim 1\%$ .

**Response : kHz range.**



## Cockcroft-Walton (3/3)

- Cockcroft-Walton voltage multiplier is one amongst various other types of voltage multipliers
- A technique convenient in accelerator installations, still in use today in number of laboratories, at the front end of the injection chain.

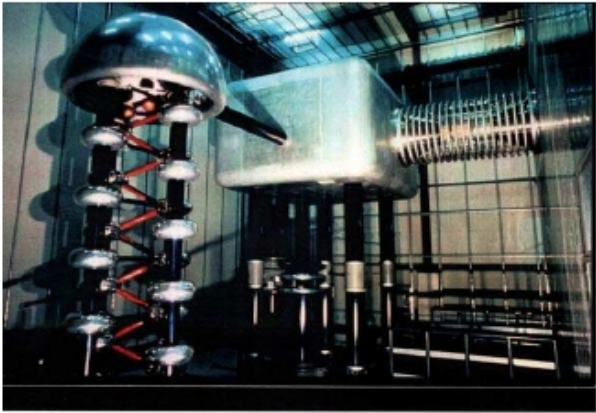

A modern version :  
the 810 kV, 30 mA Cockcroft-Walton  
injector at the PSI Mega-Watt cyclotron,  
using a voltage multiplier.

Exercise : value of  $n$  ,  $U_0$  ?

Resp. :  $n=5$ ,  $U_0 \sim 80$  kV



Some more easy kVs...



FermiLab injector (source, C-W and transfer lines  
are doubled for minimal down-time).  
H<sup>-</sup>, 20 keV DC beam, accelerated to 750 keV prior  
to bunching and injection into a DTL.

And a trend, replacement by RFQ :

*"[...] to reduce the maintenance requirements of the 750-keV  
pre-accelerator system, the replacement of the present Cockcroft-  
Walton accelerators with a single RFQ accelerator is proposed."  
(December 2008)*

# Van de Graaff (1/2)

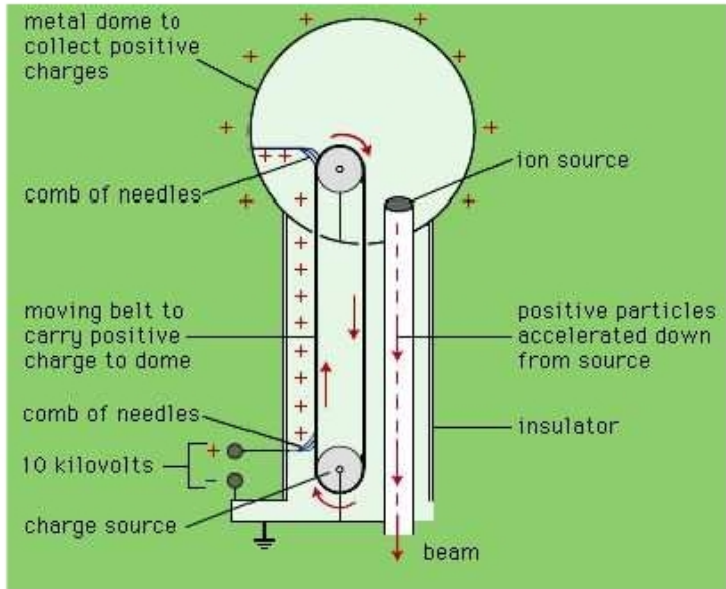

Van de Graaff electrostatic generator, principle : + or - charges, as brought by the insulating belt, are stored at the outer surface of the bulbe. Sharp points of combs are close to, but not touching, the belt, charges are transported from and to the belt by corona effect. Potential is used to accelerate particles.

- The Van de Graaff generator is simple, easy to regulate, capable of producing high voltages and therefore high accelerations of electrons or ions (compared at that time to Cockcroft-Walton).
- It is preferred when low ripple (low energy spread) is important at megavolt potentials.
- Intensity limited to ~mA.
- Effects limiting maximum achievable voltage are, size !, leakage, insulation, shape of electrodes...



In the company of its developer...

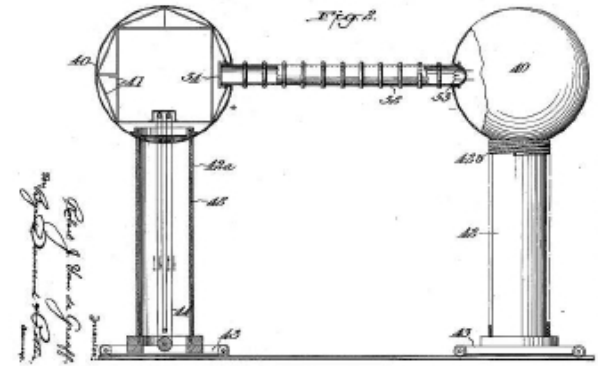

Patent figure, Dec. 1931.

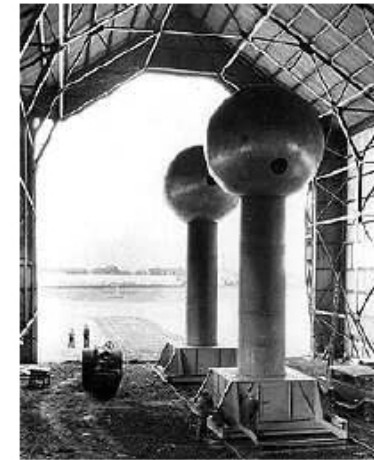

A 2 x 3.5 MV specimen, 1933.



## Van de Graaff (2/2), Tandem

- There are nowadays hundreds of Van de Graaff accelerators over the world.
- Often under the form of “tandem Van de Graaff” : doubles available energy, and gas pressurised (isolating gas SF6, freon, several  $10^5$ Pa) : limit corona effects, reduce size, source and target at ground potential.

In the “Pelletron” (1960’s), a pellet chain replaces the belt and induction devices replace the needle combs (yields better stability, reliability...)

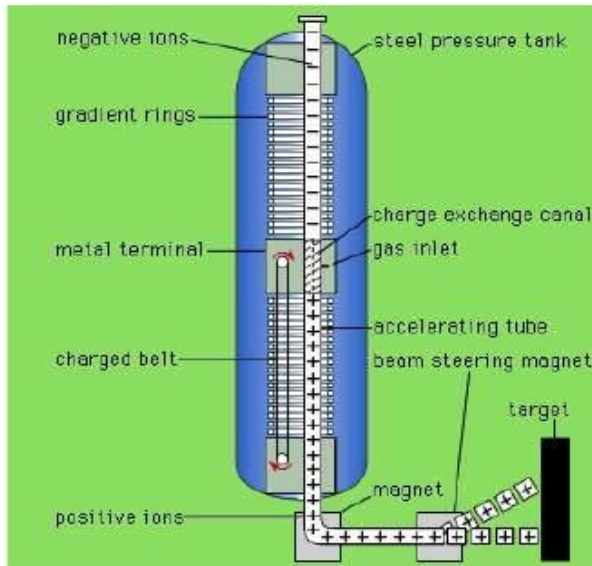

Two-stage - “tandem” - pressurized Van de Graaff.



One of the two (face-to-face) stages of the 15 MV Tandem-Van de Graaff at BNL. Can accelerate 40 different types of ions.



The tandem Van de Graaff at Western Michigan University, used for basic research, student training...



20 MV tandem VdG at Tandem Lab., Argentina (above), a smaller ancestor in earlier times (below).

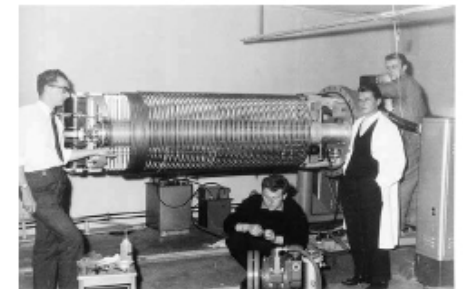

## 4 Resonant acceleration

### A BRIEF INTRODUCTION

- The principle of the resonant acceleration consists in having the particle motion satisfy some synchronism condition with a time-varying electric field.

Namely, acceleration comes from cyclic accumulation of small “longitudinal kicks”, rather than a single, big one

- First attempts are due to Gustav Ising in Stockholm, 1924.
- In 1928 Rolf Wideröe realizes the first experimental demonstration based on Ising’s concept of resonant acceleration.
- This new concept was a real big step in methods of acceleration : it avoided the use of high voltage.
- It lead in 1930 to the first practical resonance accelerator, the cyclotron...

**The cyclotron will come later in this tour**

# Let's carry on for the moment with the invention of linacs and resonant acceleration

## Ising linac

- 1924, Ising proposes the acceleration using a variable electric field between drift tubes (the father of the Linac).
- The potential wave is applied to the gaps via wires (a1, a2, a3...) with adjusted lengths to ensure synchronism.
- A consequence: only works if velocity increases with time → non-relativistic regime.
- Between gaps, particle bunchlets travel with constant velocity within drift tubes 1, 2, 3.
- It appeared not technologically possible to achieve a practical accelerator.
  - difficulty of spark excitation
  - inefficiency of wire transmission lines

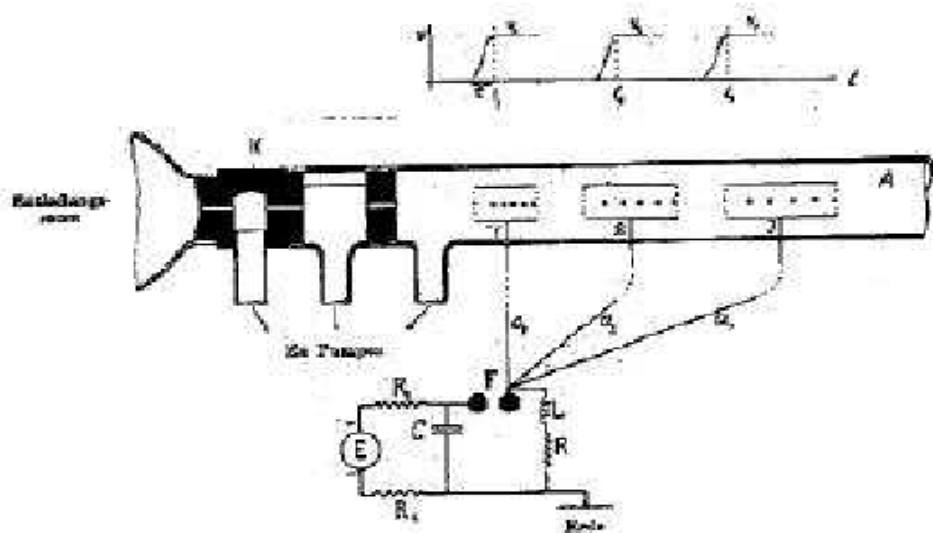

## Wideroe linac (1/3)

- 1928, Rolf Wideroe in Berlin first demonstrates resonant acceleration by applying Ising principle using a 1 MHz, 25 kV generator, connected to drift tubes forming a series of successive gaps.
- He succeeds accelerating potassium ions in that structure, up to 50 keV,
- achieving the resonance required correlation between the various parameters : type of ion, RF frequency, applied potential, gap spacing.

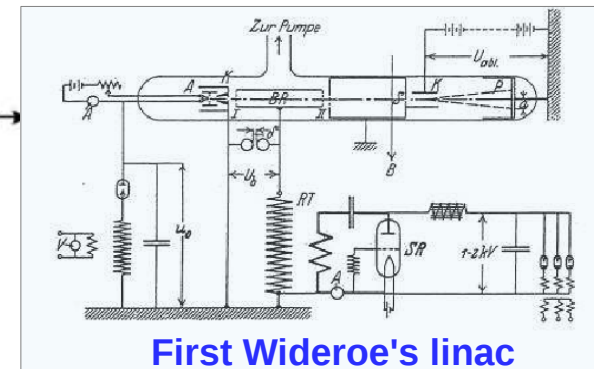
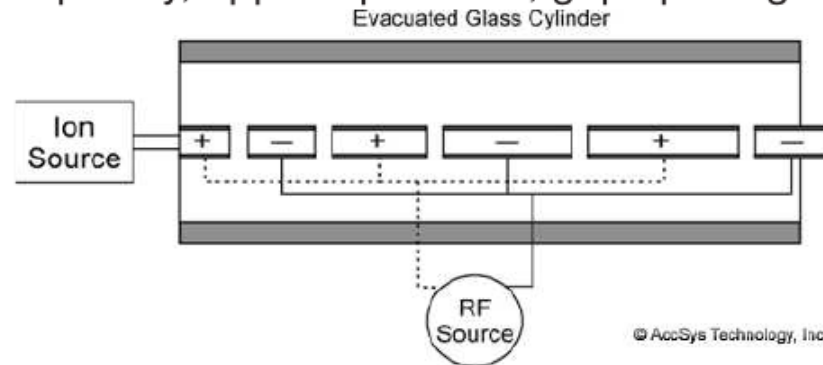

First Wideroe's linac

- Drift tubes with increasing length are arranged along beam propagation axis  
They act like Faraday cage : bunch inside tube feels no field
- They are applied  $U(t) = U_0 \sin(\omega t)$ . At a given time, potential alternates from one gap to the next ("π" mode accelerating structure)
- $U(t)$  causes accelerating (or decelerating) gradient between tubes during half a period
- After  $n$  gap, a particle at (constant) phase  $\phi$  with the wave has  $E_n = nqU_0 \sin \phi$
- Distance between gaps  $n$  and  $n+1$  is (with  $v_n$ =velocity,  $T$  =RF period =  $2\pi/\lambda$ )  
 $d_n = v_n T/2 = \beta_n \lambda/2$
- A straightforward, fundamental effect of this resonance method is "beam bunching".



## Alvarez linac (1/2)

- The development of radar technology during WWII offered pulsed, *high power*, up to GHz RF generators (“magnetron”, “klystron”), so allowing wavelengths in meter range (appropriate for ions  $v/c < 1$ ) to cm range (electrons,  $v \approx c$ ).
- 1946, L. Alvarez and coworkers at the Lawrence Berkeley Radiation Laboratory developed a proton linear accelerator based on injection of 200 MHz RF wave into a *resonant* metallic cylindrical cavity containing the wideroe-type drift tube arrangement.
  - the linac is injected with a 4 MeV electrostatic accelerator
  - protons are accelerated up to 32 MeV in the Alvarez structure

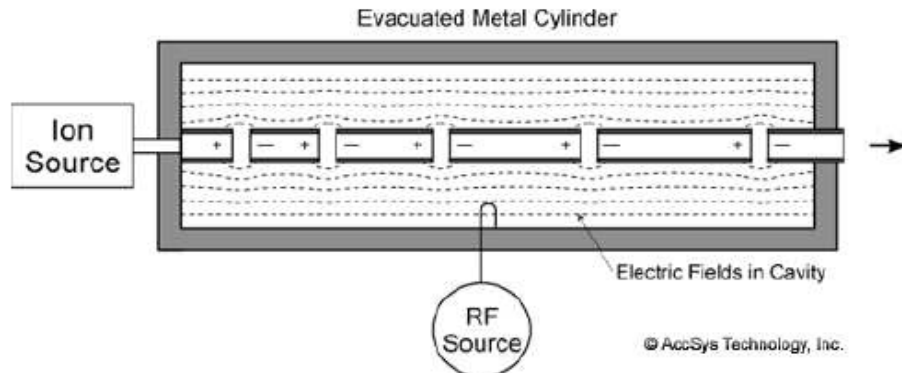

*Remember, Wideroe's tubes were in a glass cylinder (strong antenna-like power losses), they were connected to an AC generator.*

- Transverse focusing : ensured at gaps by grids shaping the (varying) E field.
- RF phasing : an accelerating standing wave fills the cavity. The particular resonant mode of interest (amongst oodles) is that with all gaps having the same polarity (“ $\beta\lambda$ ” or “ $2\pi$ ” accelerating mode)
- Evolutive geometry of the tubes (length & diameter) with distance causes cells to resonate on identical frequency.

## Alvarez linac (2/2)

- Later on longitudinal focusing (phase stability) would be invented, ensuring best transmission. Transverse focusing today ensured with quadrupoles located in the drift tubes.
- DTLs are nowadays currently used as primary injection stages in hadron linac chains, or as injectors into synchrotrons.



202M Hz/70 MeV Alvarez injector linac at ISIS, RAL.

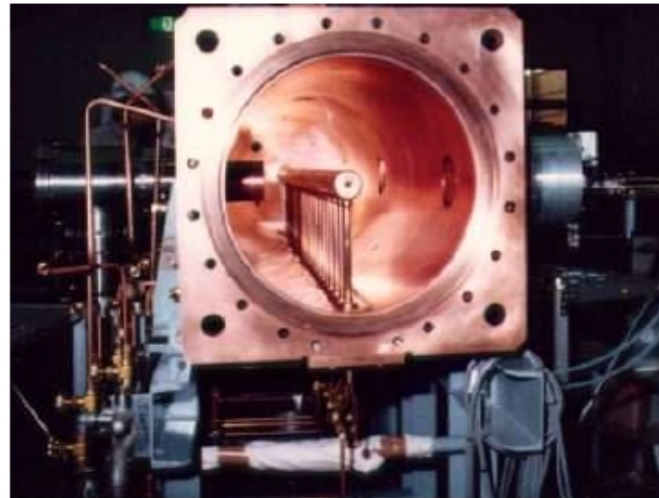

7 MeV Alvarez DTL, typical injector of medical synchrotron : pre-acceleration of protons or Carbons before injection into synchrotron.

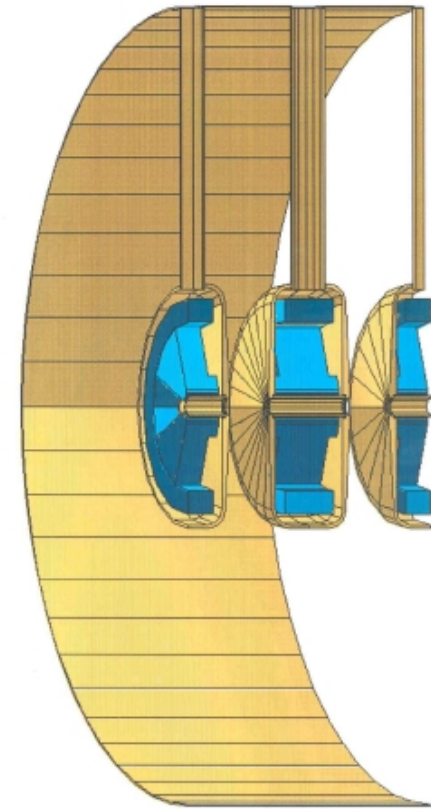

Quadrupoles in drift tubes.

# \* PRODUCTION OF RADIOACTIVE ION BEAMS \*

Cosmology, life sciences, nuclear physics

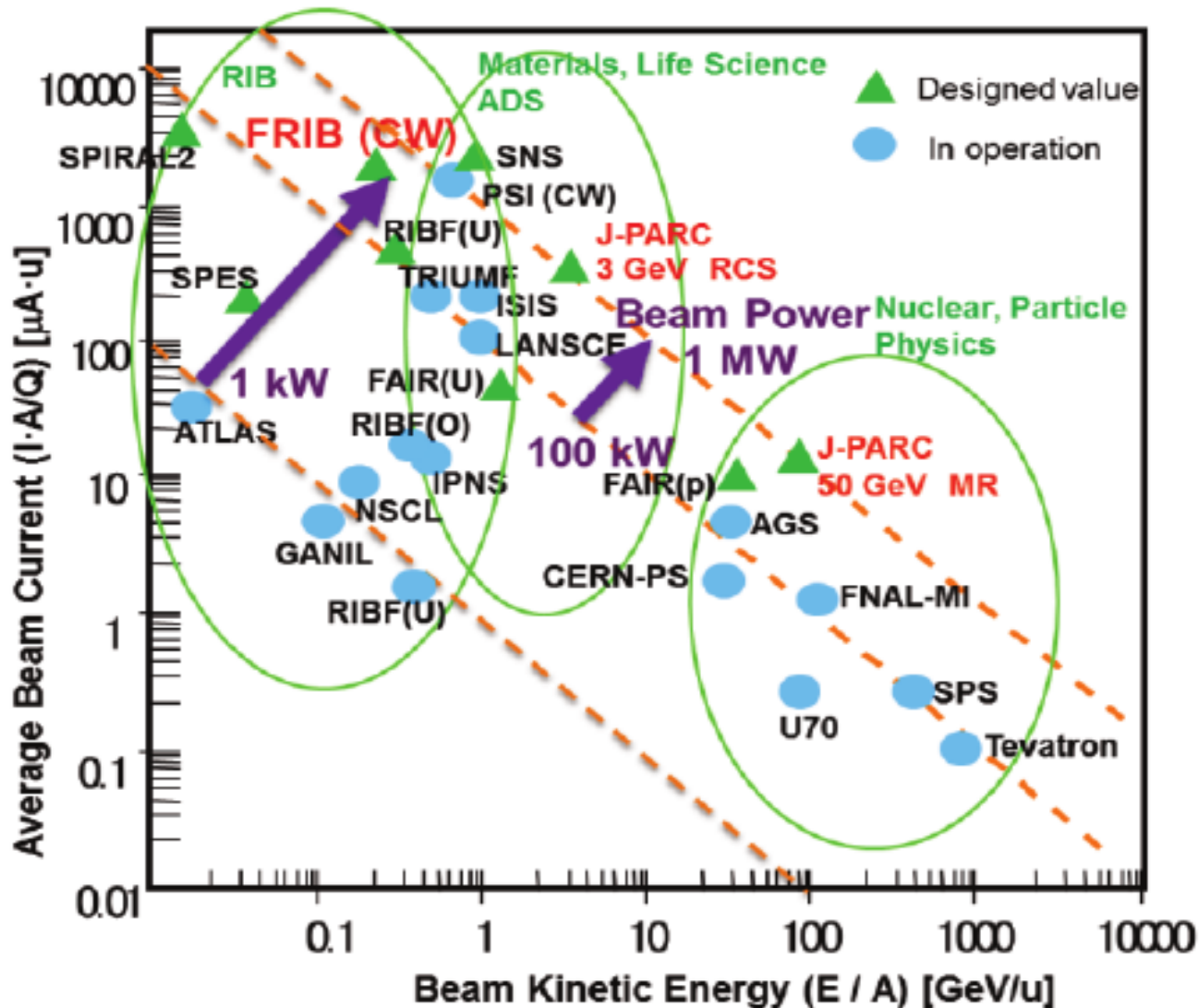

$$P[W] = U[eV] \times I[A]$$



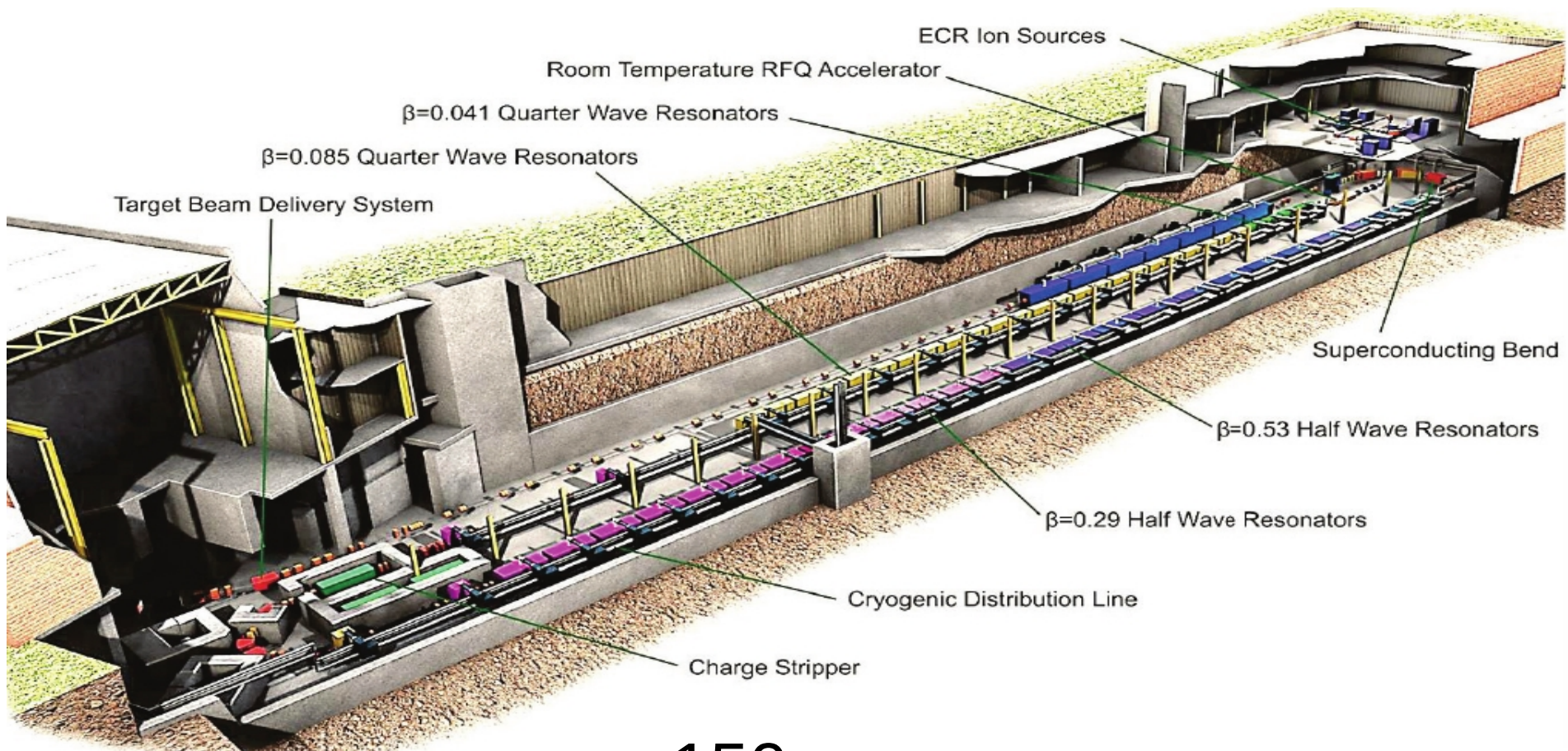

150 m

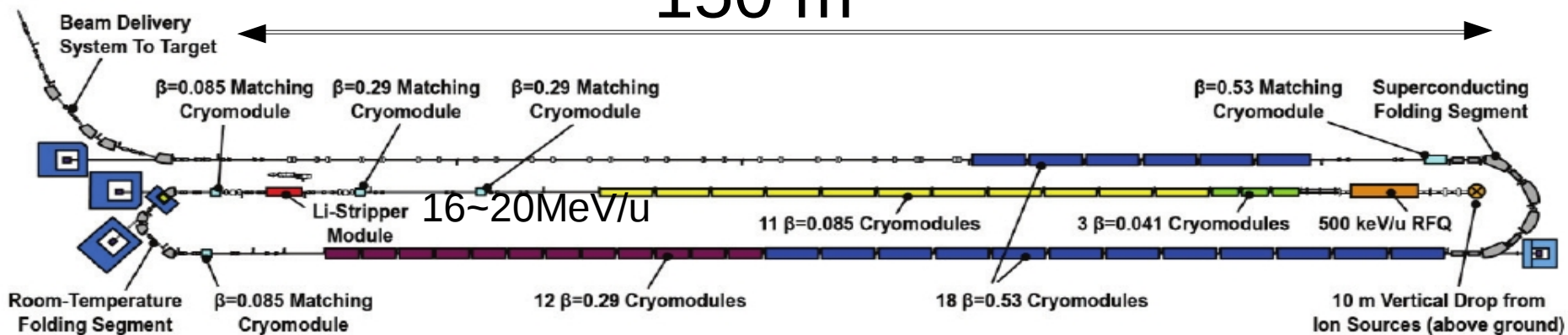



# SOME FALL FOR “NON-LINEAR DYNAMICS”

Large acceptance to emittance ratios:

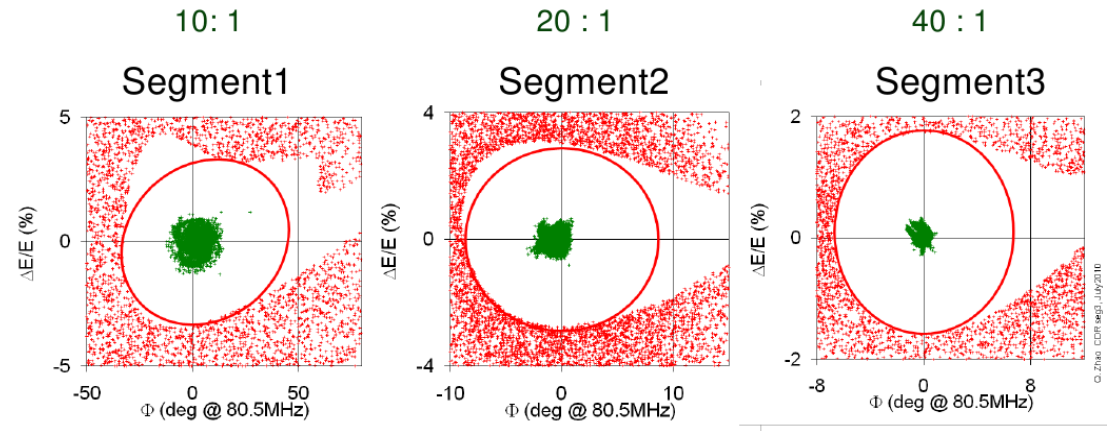

Owned  
by ASD

- 1 Ion source, Low Energy Beam Transport (LEBT) (LEBT Faraday Cups (FCs))
- 2 RFQ + Medium Energy Beam Transport (MEBT) (MEBT FC)
- 3 LS1 ( $\beta=0.041$  cryomodules) (temporary FC)
- 4 LS1 ( $\beta=0.085$  cryomodules) (Beam Dump (BD) FS-1a)
- 5 Stripper, FS1, charge selection (BD FS-1b, temporary FC)
- 6 LS2, FS2 (BD FS-2, temporary FC)
- 7 LS3 (BD Beam Delivery System (BDS))
- 8 BDS (target)
- 9 Fragment separator (target)

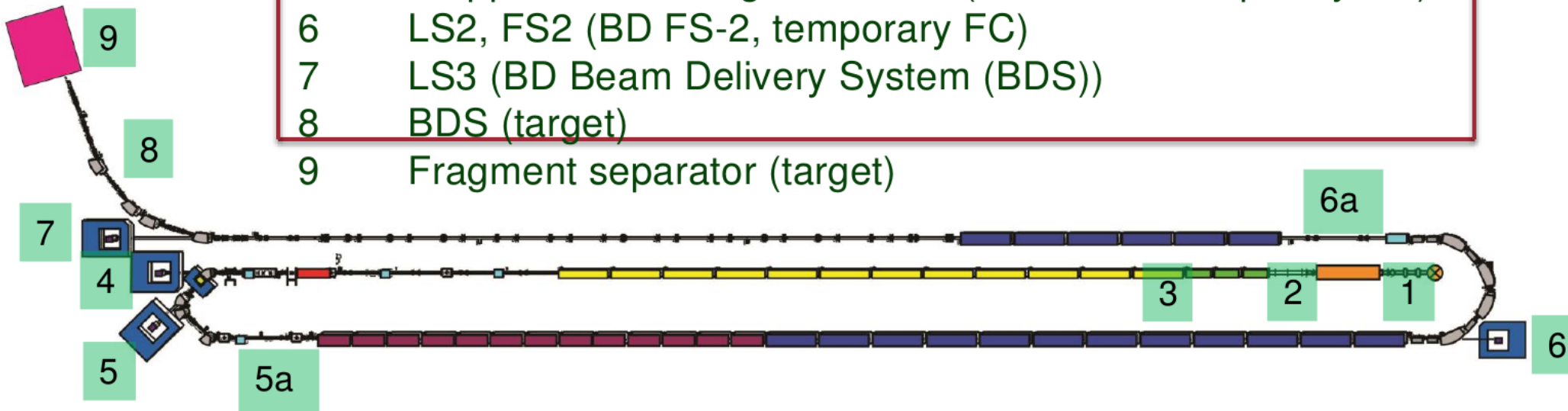

# SUPER-CONDUCTING RF TECHNOLOGIES

## FRIB Linac SRF Cavities

- Only 4 cavity types
- 1 frequency transition (between Linac Segment 1 and 2)

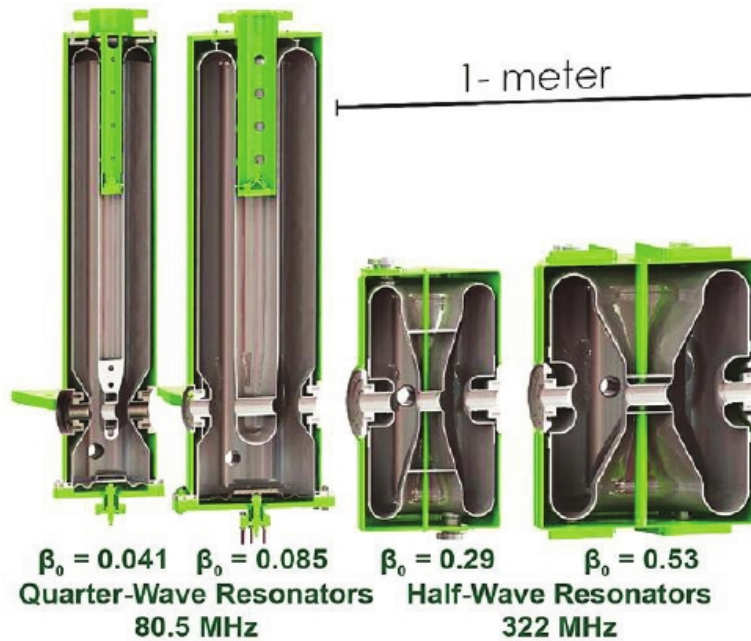

Type	$\lambda/4$	$\lambda/4$	$\lambda/2$	$\lambda/2$
$\beta_{opt}$	0.041	0.085	0.29	0.530
f(MHz)	80.5	80.5	322	322
Aperture (mm)	30	30	30	40
$V_a$ (MV)	0.81	1.62	1.90	3.70
$E_p$ (MV/m)	30.0	31.5	31.5	31.5
$B_p$ (mT)	53	71	75	77
T(K)	4.5	4.5	2.0	2.0

# \* ACCELERATOR-DRIVEN SUBCRITICAL REACTOR \*

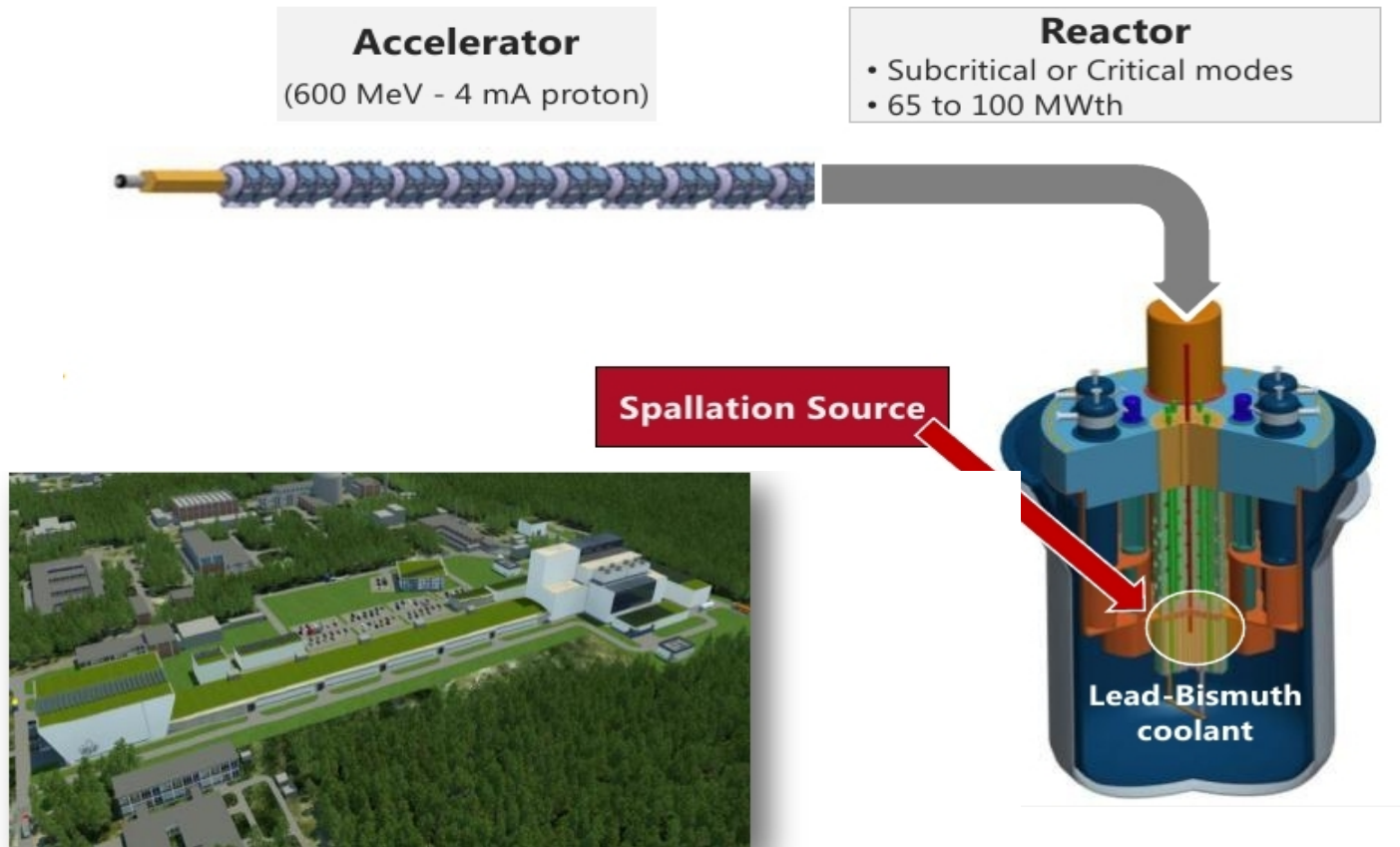

**MYRRHA**

**M**ultipurpose **h**ybrid **R**esearch **R**eactor for **H**igh-tech **A**pplications  
**A** flexible and fast spectrum irradiation facility

- **Required beam power  $P_B$ , for  $P_{th}$  reactor power :**  
**With beam energy  $E_B \approx 1$  GeV, a handy estimate is**

$$P_B \approx \frac{1}{2}(1 - k_{\text{eff}}) P_{\text{th}}$$

$$P_B = E_B \frac{P_{\text{th}} (1 - k_{\text{eff}})}{f E_f k_{\text{eff}}} \left\{ \begin{array}{l} k_{\text{eff}} = \text{neutron multiplication factor} = \frac{\text{n produced}}{\text{n absorbed}} \approx 0.95 - 1^- \\ E_f = \text{fission energy} \approx 200 \text{ MeV} \\ f = \text{fraction of neutrons causing fission} \approx \frac{1\text{GeV-p } 20\text{n/incident p}}{2.5\text{n/fission}} \end{array} \right.$$

- $k_{\text{eff}}$  is central to the accelerator parameters, the closer it is to 1, the lower the beam power to be brought in - but, drawback, the closer the reactor core to critical.

<b>- Typical numbers -</b>			
	<b>ADS</b>		<b>Proton beam</b>
	<b>thermal power</b>	$k_{\text{eff}}$	<b>Energy / Current / Power</b>
<b>Demo transmuter MYRRHA:</b>	<b>50-100 MW-th</b>	$\approx 0.95$	<b>600 MeV / 4 mA / 2.4 MW</b>
<b>EFIT industrial transmuter:</b>	<b>several 100 MW-th</b>	$\approx 0.97$	<b>800 MeV / 20 mA / 16 MW</b>
<b>China's demonstrator program:</b>	<b>1000 MW-th</b>		<b>1.5 GeV / 10 mA / 10 MW</b>



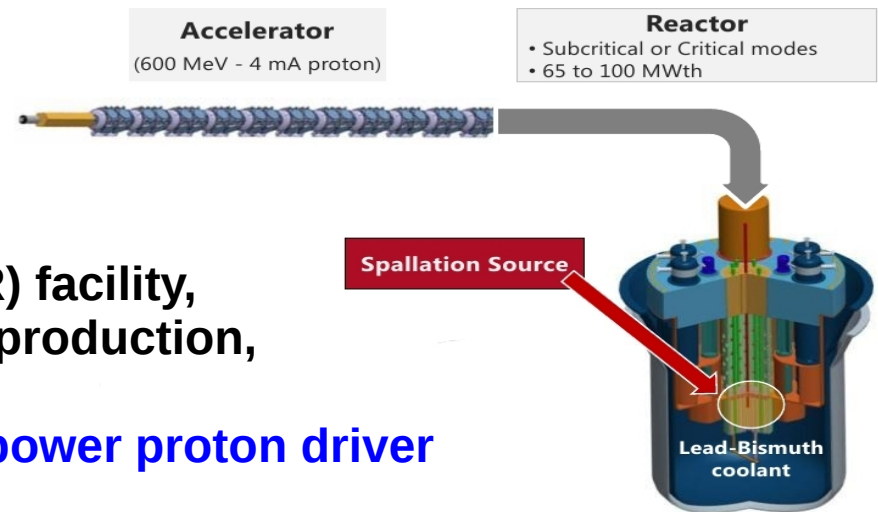

- An accelerator driven sub-critical reactor (ADS-R) facility, aimed at nuclear waste treatment and/or energy production, is comprised of three ensembles: **a sub-critical reactor, a spallation target, a high power proton driver**
- The reactor is operated in the sub-critical regime, with a neutron multiplication factor  $k_{eff} = \text{number of neutrons produced} / \text{number of neutrons absorbed} \approx 0.95-0.98$   
  
(the design of the European MYRRHA for instance, features  $k_{eff} \approx 0.95$ , a 0.03 downgrade from 0.98, i.e., the maximum authorized for nuclear compounds storage, accounting for diverse possible incidental reactivity effects, with causes such as misloading, void coefficient perturbations, etc.).
- A high-power proton beam provided by the accelerator installation bombards a spallation target to provide a supply of neutrons to drive the subcritical reaction.
- For a proton beam in the  $E \approx 1 \text{ GeV}$  range, the required beam power to produce a reactor thermal power  $P_{th}$ , is given with reasonable approximation by  
$$P_b \approx 0.5 (1 - k_{eff}) P_{th}.$$
- $k_{eff}$  is central to the accelerator parameters, the closer it is to 1, the lower the beam power required to produce the spallation reaction, but the closer the reactor core is to criticality.

**X-LASER**

**actually known as**

**FEL**

**or**

**SASE-FEL**

**Main interest :**

**Laser-like photon beams**

**Potential for femto-second X-pulse source**

# FEL (wiki) :

- The widest frequency range of any laser type
- Widely tunable
- Designs allow wavelengths in microwave region, or terahertz, infrared, the visible spectrum, ultraviolet, X-ray with highest electron beam energies
- The term free-electron lasers was coined by John Madey in 1976 at Stanford University
- The work emanates from researches done by Hans Motz and his coworkers. They built an [undulator](#) at Stanford in 1953, using the wiggler magnetic configuration which is the heart of a free electron laser
- Madey used a 43-MeV electron beam and 5 m long wiggler to amplify a signal

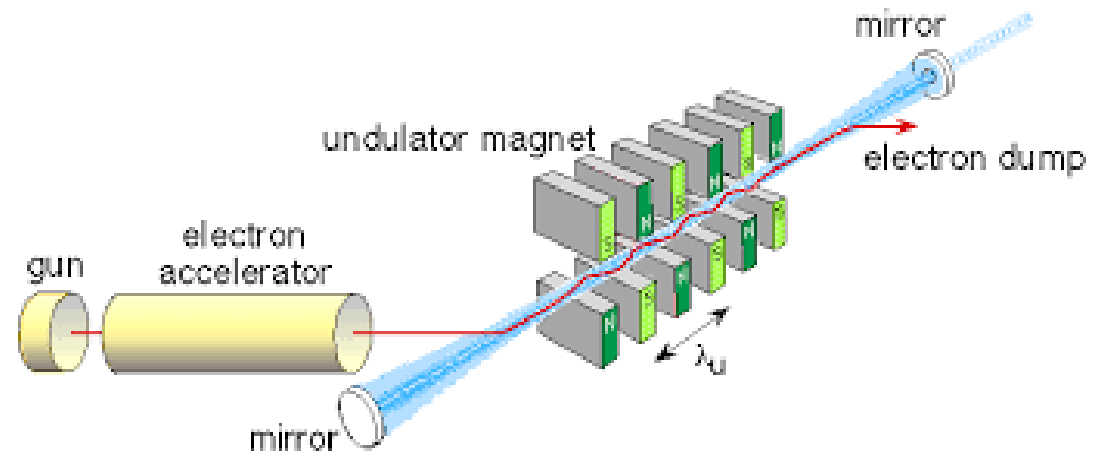

# Principle of “undulator radiation”

Electron beam, from ring or linac

A long string (meters) of ~cm scale magnetic periods wiggles the e-beam over meters

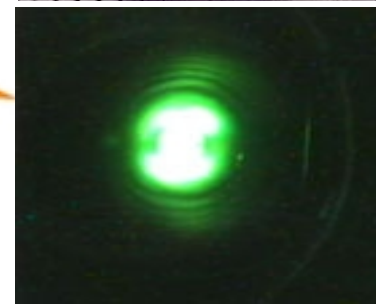
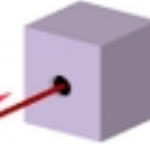
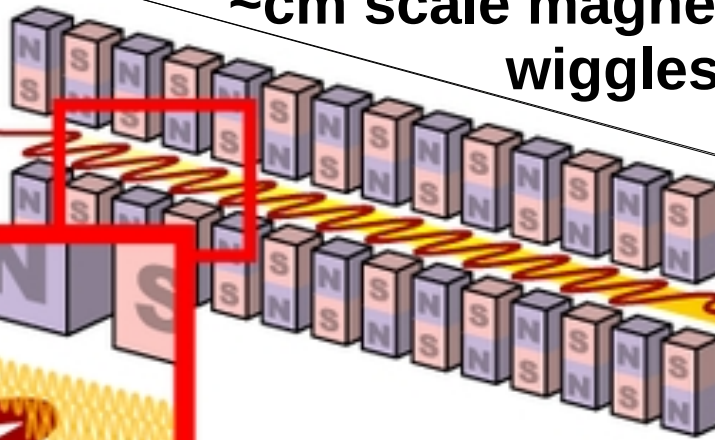
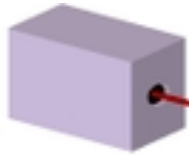

In an FEL, the undulator is embedded in a resonant cavity, just as a laser medium.

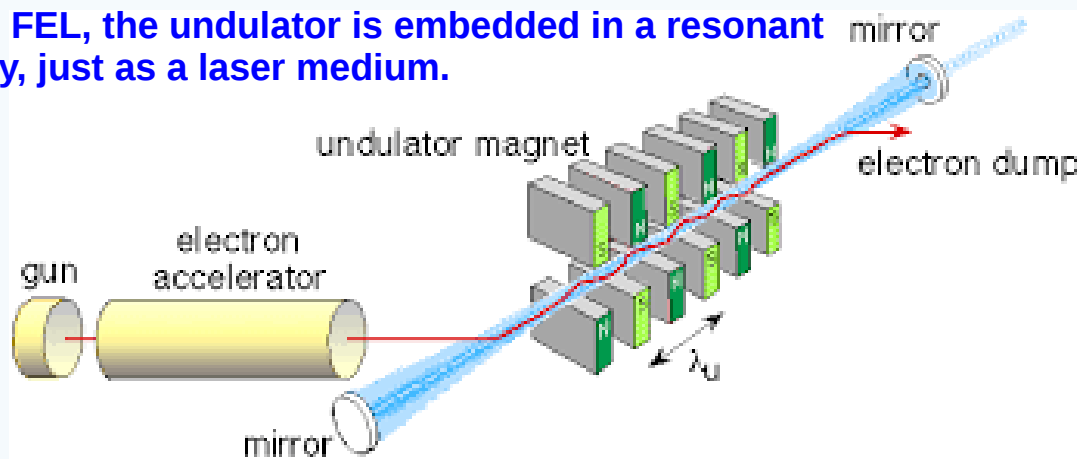

Monochromatic light spot

$$\lambda(\theta) = \lambda_u / (2\gamma^2 (1 + \gamma^2 \theta^2 + K^2 / 2))$$



The accelerator in that application can be **a ring**, or **a linac**.

That depends on the type of application, on desired photon properties.

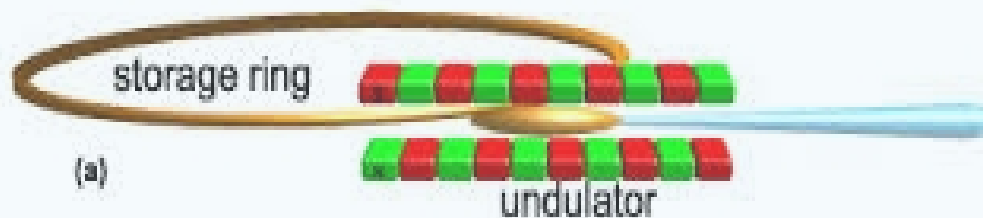

**We'll be back to ring light sources, later in the tour...**



# Linac FEL

- Principle layout of the FEL installation

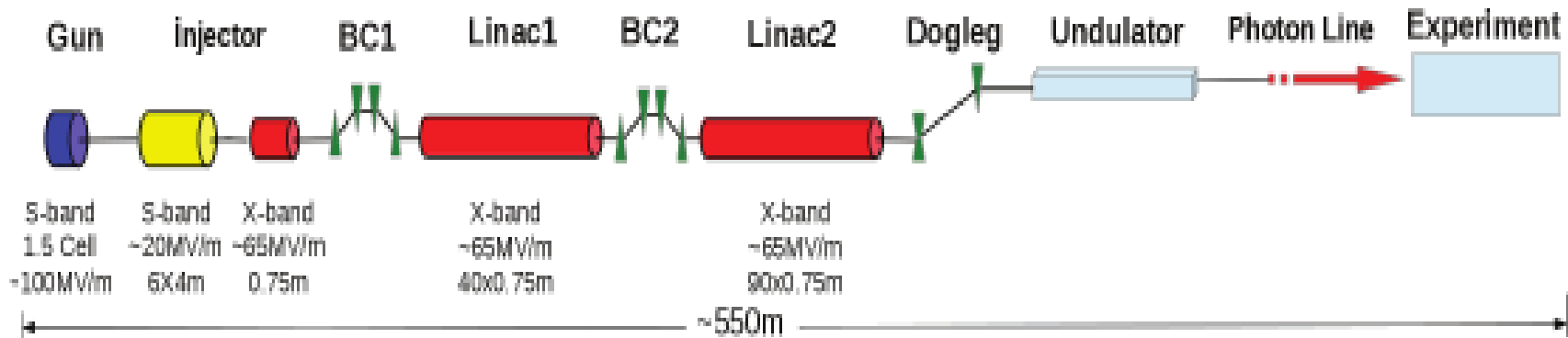

- The linac sections in that installation :

Their principles remain the same as for *proton/ion* linacs, id est,

- an accelerating gap,
- in a resonant cavity
- with some technological subtleties, proper to ultra-relativistic velocity of the electron beam



**FLASH SC linac,  
at DESY, in  
Hamburg, Germany.**

The linac can be a *re-circulating linac*, moreover with *energy recovery*, “*ERL*”...

## Principle of an ERL

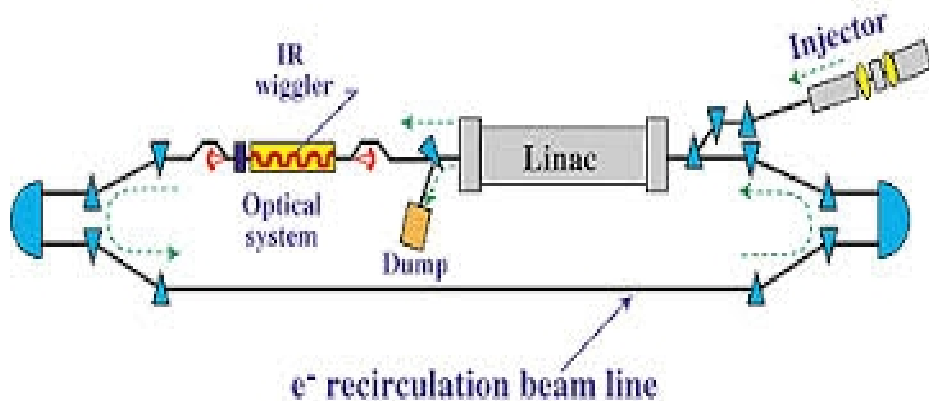

### JLab ERL-FEL Specifications

Wavelength range (IR)	1-14 $\mu$ m
Energy/pulse	120 $\mu$ J
Pulse repetition frequency	Up to 75 MHz
Pulse length	500-1700 fs FWHM
Maximum average power	>10 kW
Wavelength range (UV/VIS)	250-1000 nm
Energy/pulse	20 $\mu$ J
Pulse repetition frequency	Up to 75 MHz
Pulse length	300-1700 fs FWHM
Maximum average power	>1 kW

# Self-Amplified Spontaneous Emission “SASE-FEL”

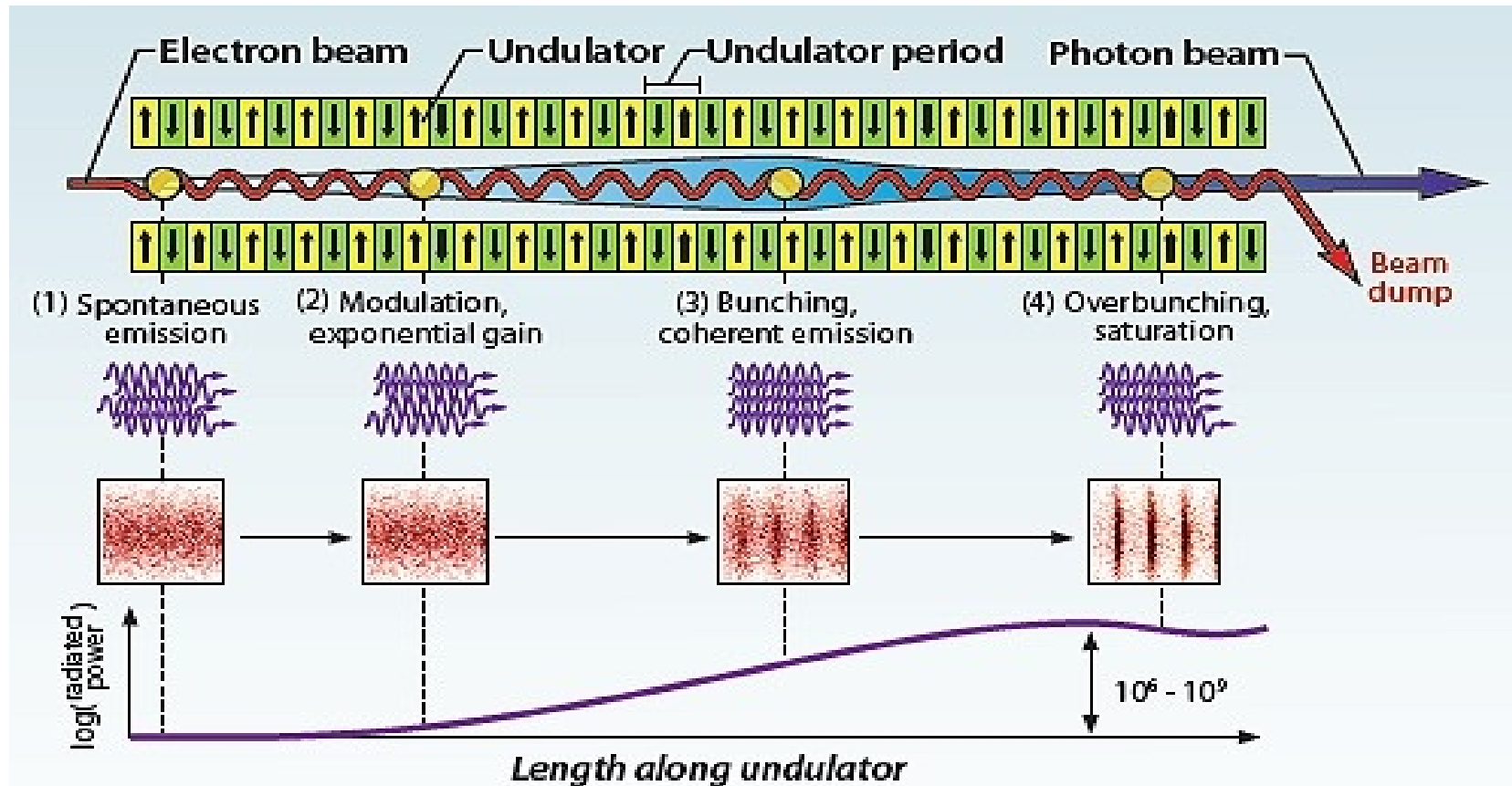

- Principle : the e-beam density modulates into short bunches,  $l \sim \lambda$ .
  - Thus : coherent radiation,  
power  $\sim (Ne)^2$  rather than (incoherent) power  $\sim N e^2$ ,  
i.e., high brightness highly collimated femtosecond X-ray pulses.  
Can make life science X-movies !



# FLASH SASE FEL INSTALLATION, HAMBURG

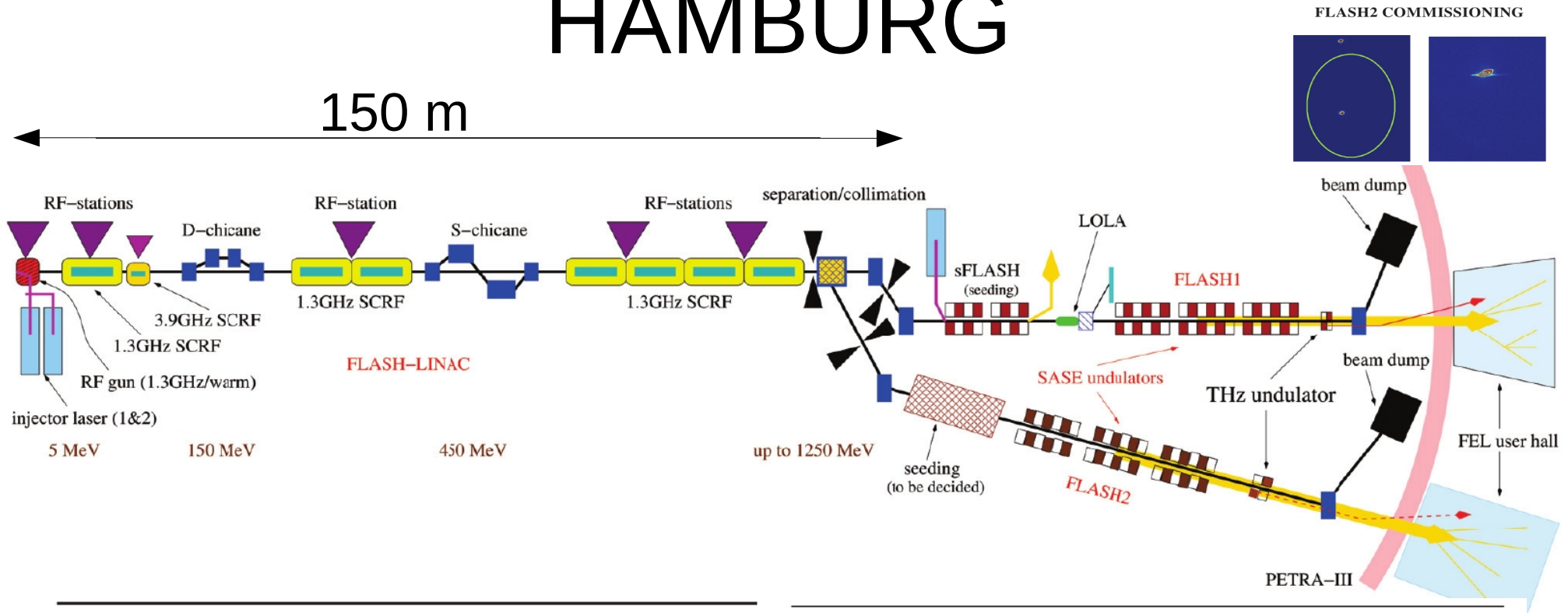

$e^-$  :

emittance	$\beta\gamma\epsilon_{x,y}$	
(1 nC, on-crest, 90% rms)		1.4 mm mrad
charge		0.08 - 1.0 nC
peak current		0.8 - 2.0 kA
beam energy		380 - 1250 MeV
bunches / train		1 - 450
bunch spacing		1 - 25 $\mu$ s
train repetition frequency		10 Hz

$\gamma$  (FLASH1):

wavelength (fundamental)		4.2 - 45 nm
average single pulse energy		10 - 540 $\mu$ J
pulse duration (fwhm)		<30 - 200 fs
spectral width (fwhm)		0.7 - 2.0 %
peak power		1 - 3 GW
peak brilliance		$10^{29} - 10^{31}$ (+)
average brilliance		$10^{17} - 10^{21}$ (+)
(+): photons/( s mm <sup>2</sup> mrad <sup>2</sup> 0.1%bw )		

Let's conclude :  
what are the plans with these sort of things,  
what is the future ?

*Cutting edge research, based on a  
revolutionary tool*

### **An instance, from FEIS-2 conference web site :**

- **Femtosecond Electron Imaging and Spectroscopy**
- **Structure and spectroscopy of matter with atomistic space and femtosecond time resolution, enabled by the development of extremely bright radiation sources, such as high-brightness X-ray and electron beam systems. The capabilities of generating ultrabright sources and very high level of control in delivering intense electron beams through tuning of source geometry, pulse shaping, laser-electron pulse synchronization, and understanding of space-charge effects are now synergistically enabling ultrabright electron microscopes and electron microdiffraction systems for femtosecond imaging and spectroscopy.**
- **FEIS-2 will bring together leaders engaged in cutting edge development of high-brightness electron and X-ray beam systems and their applications to frontier science problems, in order to showcase recent progress and discuss future directions and opportunities. It will also attempt to draw comparisons to other recently emerging approaches to ultrafast observation. The workshop will build on the potential synergy between related technology developments and various emerging scientific opportunities.**

# CYCLOTRONS

# A map of High Power Proton accelerators

Linacs  
Cyclotrons

ADS  
Domain

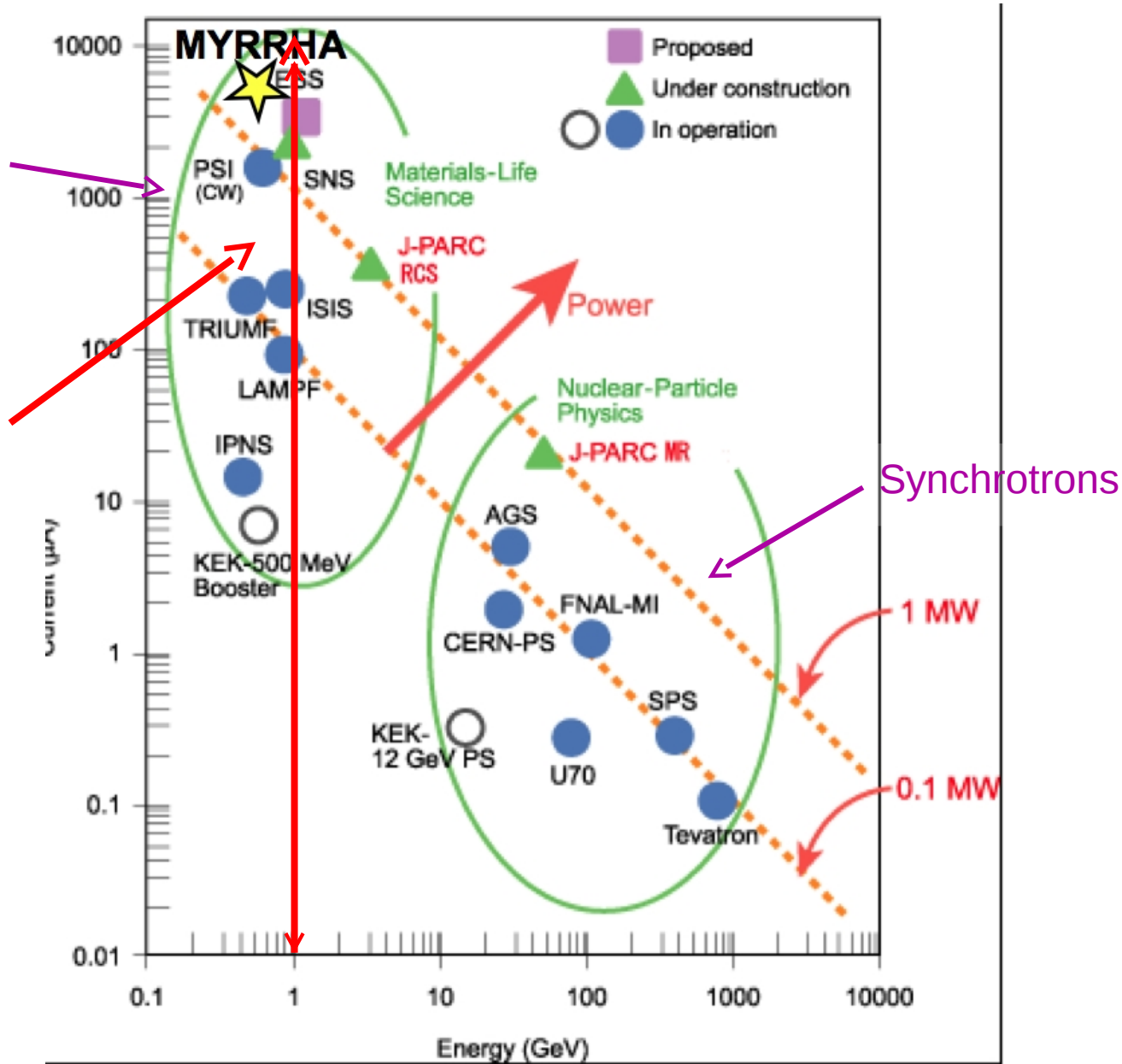



**\* Again, let's consider neutron production \***  
**High power, this is where we are today :**  
**PSI, 600 MeV, 1.2 MW, CW**

**1973**

- 1 Hans Willax
- 2 Miguel Olivo
- 3 Thomas Stammbach
- 4 Werner Joho
- 5 Christa Markovits





# 1966: SIN early Design – Feb. 1974:1st 100 $\mu\text{A}$ beam

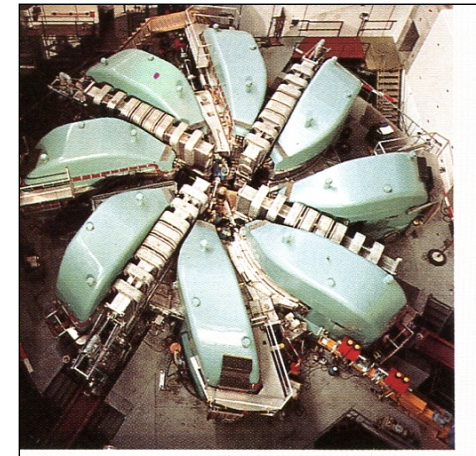
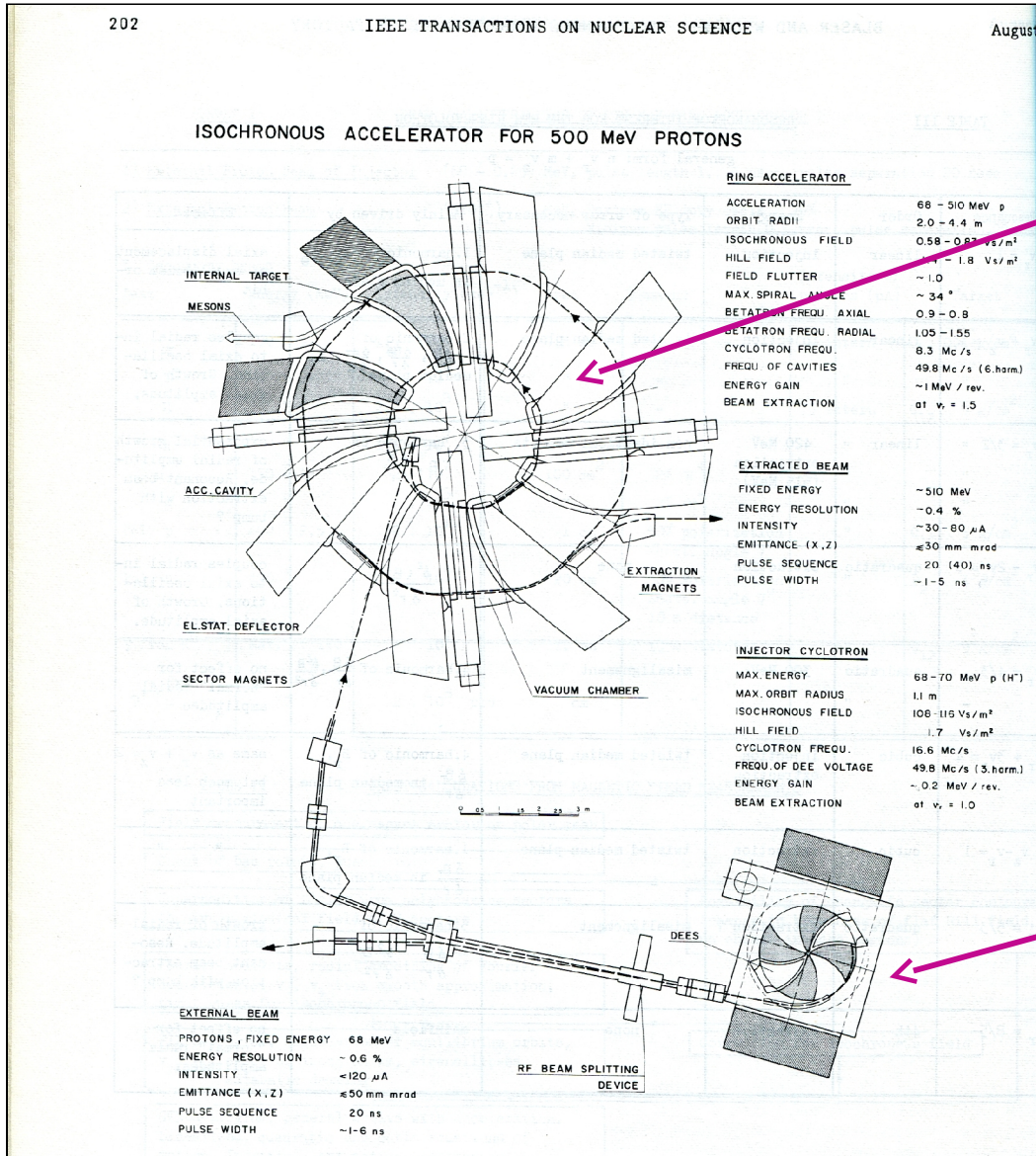

The 590 MeV Ring Cyclotron

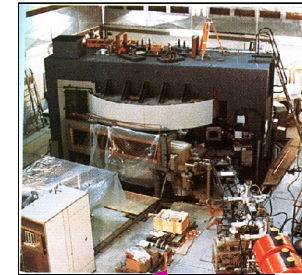

The old 72 MeV Philips injector

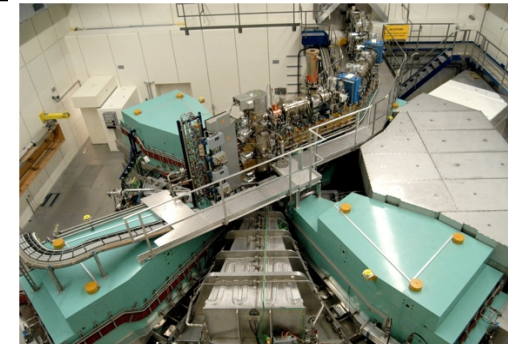

Nowaday's 72 MeV injector

Injector 2 Cyclotron for 72 MeV proton beams.

# Towards Higher intensities: Today 30 times more Intensity

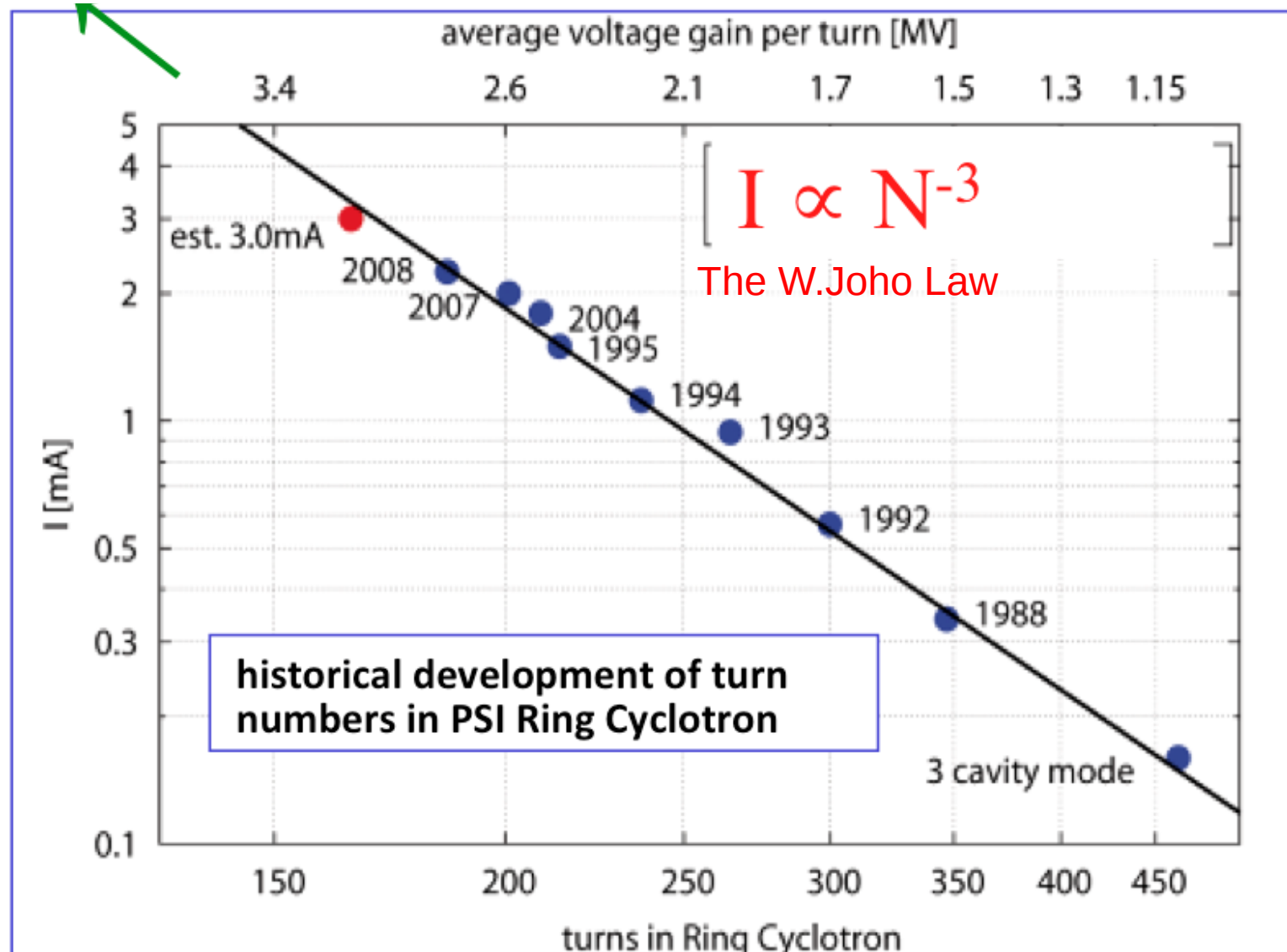



# SINQ @ PSI

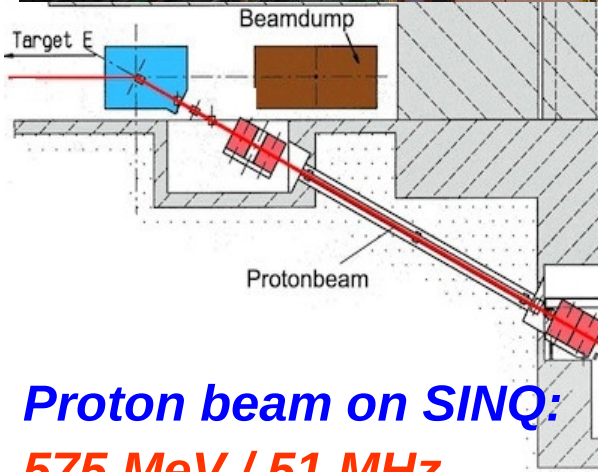
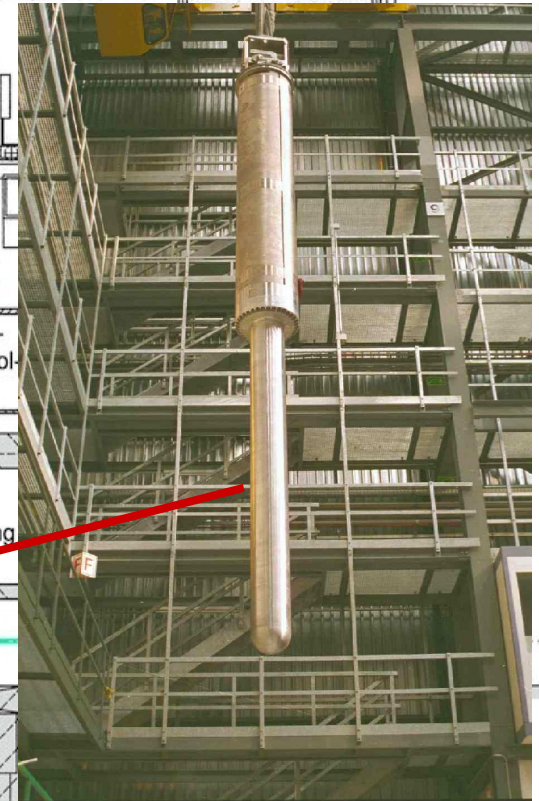
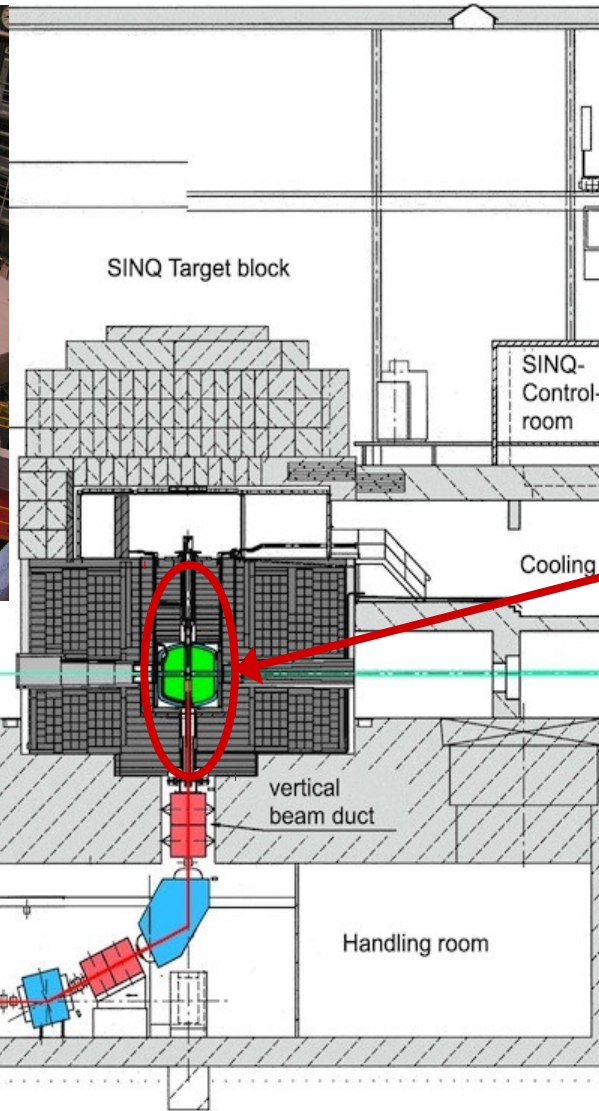

**Proton beam on SINQ:**  
**575 MeV / 51 MHz**  
**p-Current: 1.5 / 1.6 mA**  
**Power: 0.8 - 0.9 MW**

**Total Power Deposition  
in Target Assembly  
~ 575 – 610 kW**



# \* ACCELERATOR-DRIVEN SUBCRITICAL REACTOR \*

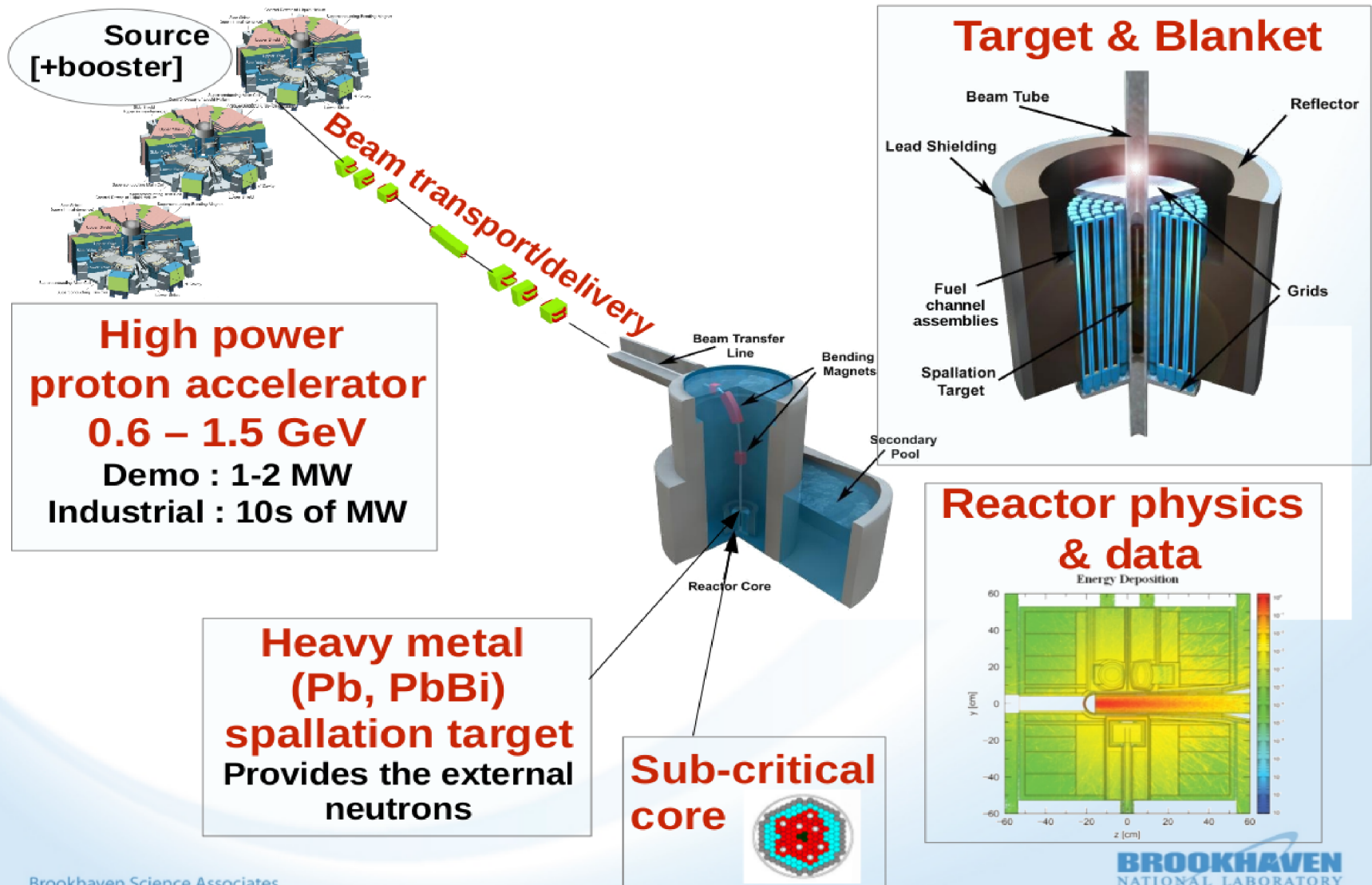

# Big discussion : which is optimal ?

Reference : US ADS White Paper (2010)

- Separate sector cyclotron

Paul Scherrer Institute,  
590 MeV, 1.3 MW CW beam  
First beam 1973



- Normal conducting proton linear accelerator

LANSCE 800 MeV n science center linac, first beam 1972.  
Ran in 1 mA / MW range in the 1980s,  
120 Hz repetition rate, DC 7.5%.

- Superconducting linear accelerator

SNS 1 GeV n science linac at ORNL,  
beam power 1.2~1.4 MW.  
Pulsed, DC ~6%. Accelerates H- for  
stripping injection into accumulator ring,  
First beam 2006



**There is much more about  
application of cyclotrons**

**We'll be back to that class of ring  
accelerators, later...**

**For the moment, let's do some  
theory**

## Cyclotron (1/5)

- 1929-1930, Ernest O. Lawrence inspired by Wideroe & Ising ideas invents (the principle of) the cyclotron : having read Wideroe's paper, he speculated on the use of a magnetic field to bring the particle back to a *single* accelerating gap next to acceleration.

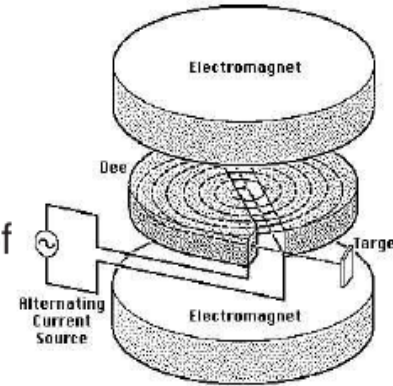

- Doing so he found that the revolution frequency in uniform B is constant : the “cyclotron angular frequency”,  $\omega_0 = qB/m$
- That allows RF gap voltage at constant frequency,  $f_{RF} = qB / 2\pi m$ .

- 1931, Stanley Livingston, Berkeley, demonstration with 5-inch cyclotron by acceleration of hydrogen ions up to 80 KeV (about 40 turns up to  $r \approx 4.5$  cm).
- 1932,  $\phi 30$  cm cyclotron built by Lawrence produces protons at 1.25 MeV and breaks atoms *a few weeks after Cockcroft-Walton's Li + p*
- 1934, Berkeley, E.O. Lawrence builds a 27-inch cyclotron, accelerates protons to 3 MeV and D to 5 MeV
- 1939, E. O. Lawrence receives the Nobel Prize “for the invention and development of the cyclotron and for results obtained with it, especially with regard to artificial radioactive elements”.

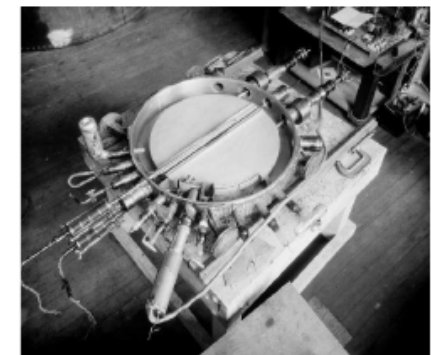
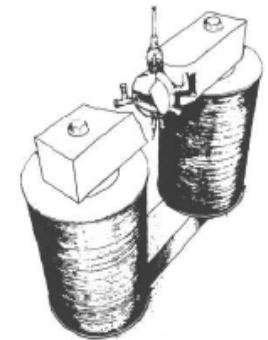

- That was just the beginning of a lasting story, yet...

The device is inserted in the gap of an electromagnet.



# Cyclotron (2/5) - classical

- Non-relativistic cyclotron

- orbit :  $r = v/\omega_0 = mv/qB$

- focusing (1) :

$$F_z = qvB_r \approx qv \frac{\partial B_r}{\partial z} z \equiv qv \frac{\partial B_z}{\partial r} z$$

$$\ddot{z} - \frac{qv}{m} \frac{\partial B_z}{\partial r} z = 0 \rightarrow \omega_z^2 / \omega_0^2 = \nu_z^2 = -\frac{r}{B_z} \frac{\partial B_z}{\partial r} = -k, \quad \nu_z = \sqrt{-k}$$

hence the field index  $k$  needs be negative :  $B_z$  is slowly decreased with radius.

Similarly,  $\nu_r = 1 + k$ . This sets the requirement  $-1 < k < 0$

- focusing (2) : is also ensured at lower energy by the electric field.

- isochronism :

The condition for vertical focusing,  $-1 < k < 0$  ( $B$  is not constant), spoils the isochronism.

As a consequence, the phase is not constant (ABCDE path)

- bunching : particle beam injected into the cyclotron necessarily gets bunched, at the frequency of the RF (the time interval between two bunches is an RF period)

- The classical limit ( $\gamma \approx 1$ ) is  $\sim 25$  MeV for protons, 50 MeV for D and  $\alpha$ , (about 2 – 3% increase in mass), GANIL in Caen accelerates Carbon to about 100 MeV/u...

- That was enough energy to transmute all nuclei... The classical cyclotron allowed discovering oodles of nuclear reactions and isotopes.

Yet, let's keep in mind : transmutation was not the all story

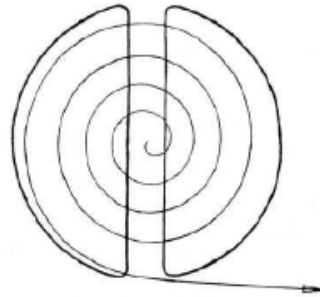

With  $B$  constant in time and uniform in space, as particles gain energy from the rf system, they stay in synchronism, but spiral outward in  $r$ .

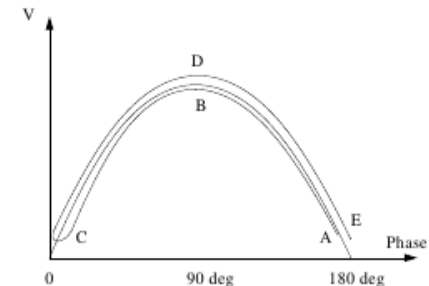
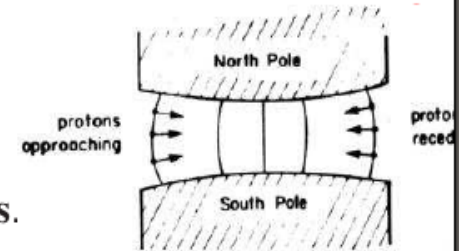

## Cyclotron (3/5) - classical

- Relativistic energies, the bad news :

- The cyclotron resonance  $\omega_0 = qB/\gamma m$ , with  $r = \beta c/\omega_0$  yields  $k = \frac{\beta}{\gamma} \frac{\partial \gamma}{\partial \beta} = \beta^2 \gamma^2$

- so  $k$  cannot satisfy  $-1 < k < 0$ ,

isochronism requires that  $B(r) \propto \gamma$ , which yields vertical defocusing...

- That was the end of the story,  $\sim 25$  MeV protons, etc... :

Hans Bethe (1937) :

“... it seems useless to build cyclotrons of larger proportions than the existing ones... an accelerating chamber of 37 cm radius will suffice to produce deuterons of 11 MeV energy which is the highest possible...”

Frank Cole : “If you went to graduate school in the 1940s, this inequality ( $1 < k < 0$ ) was the end of the discussion of accelerator theory.”

- Until...

## Cyclotron (4/5) - Thomas focusing

- 1938, L.H. Thomas, “The Paths of Ions in the Cyclotron”, introduces the “Thomas focusing”, based on separate sector bending, namely, “edge-focusing”,
- 1954, Kerst, spiral edges increase vertical focusing further  

$$\nu_z = \sqrt{-k + F^2(1 + 2 \tan^2 \xi)}, \quad F = \text{Flutter} = \frac{\langle B^2 \rangle - \langle B \rangle^2}{\langle B \rangle^2}$$
- That allowed having  $B(r)$  increase in proportion to  $\gamma$ , so to ensure constant RF frequency ( $\omega_0 = qB/\gamma m$ ), while *preserving vertical focusing*.
- Modern cyclotrons still rely on these principles

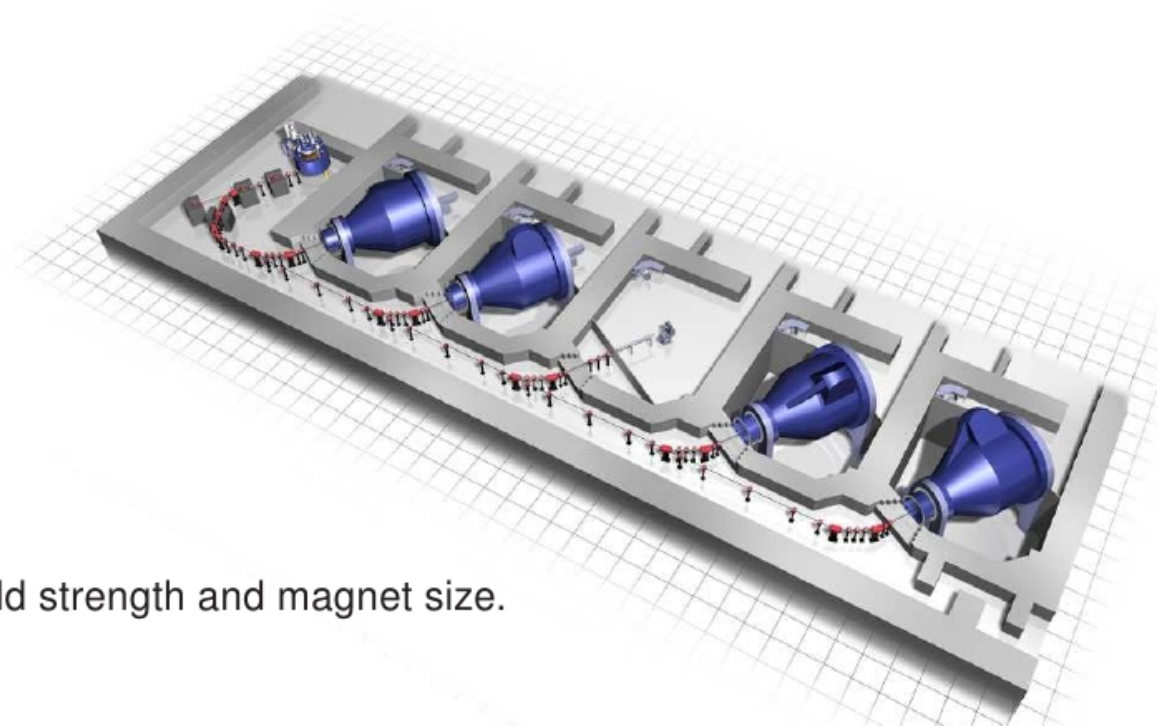
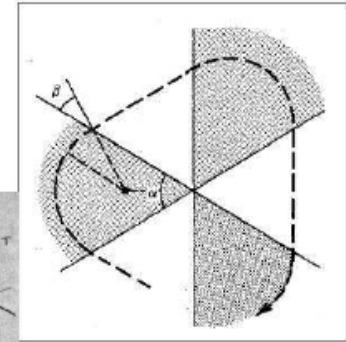
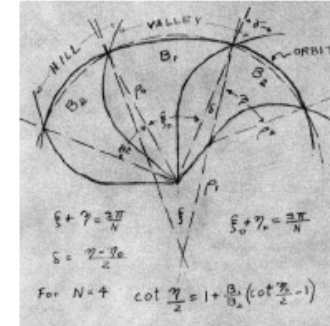

- Cyclotron is limited in energy by its field strength and magnet size.

# SYNCHROTRONS



**Main specificities,  
compared to what  
we have already  
learned :**

**PHASE STABILITY**

***(1944 - McMillan & Veksler)***

**STRONG FOCUSING**

***(1952 - Christofilos &***

***Courant, Livingston, Snyder)***

# Components of a synchrotron

- Steering :  
bending magnets
- Focusing :  
Quadrupole magnets
- Acceleration :  
RF cavity
- Vacuum chamber
- Injection, extraction



# LIGHT SOURCES

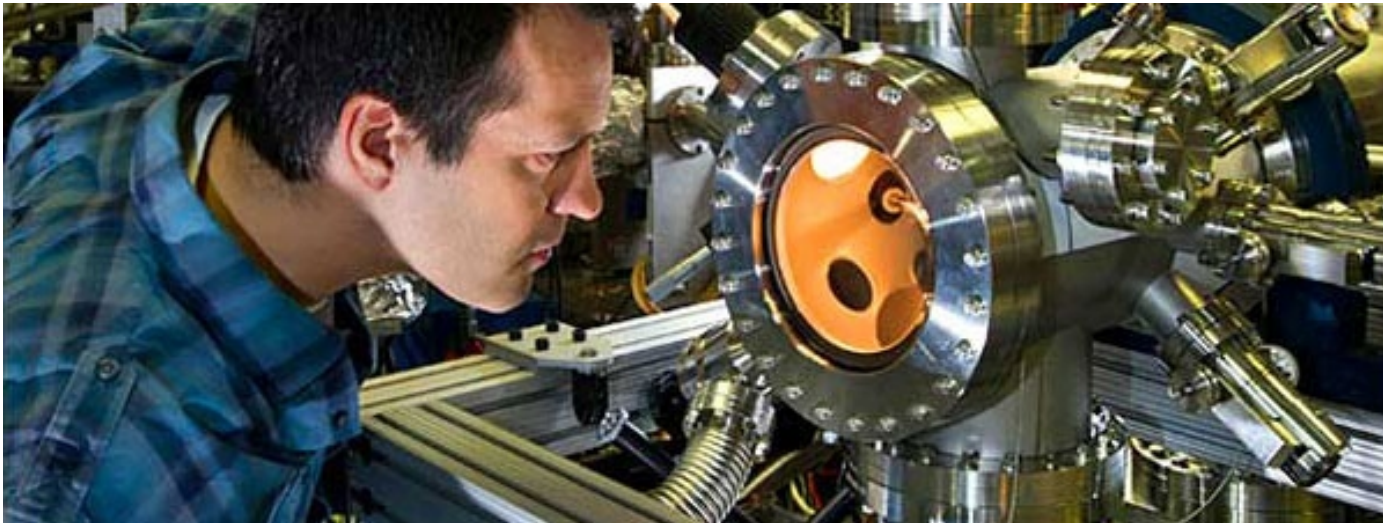

# How this started

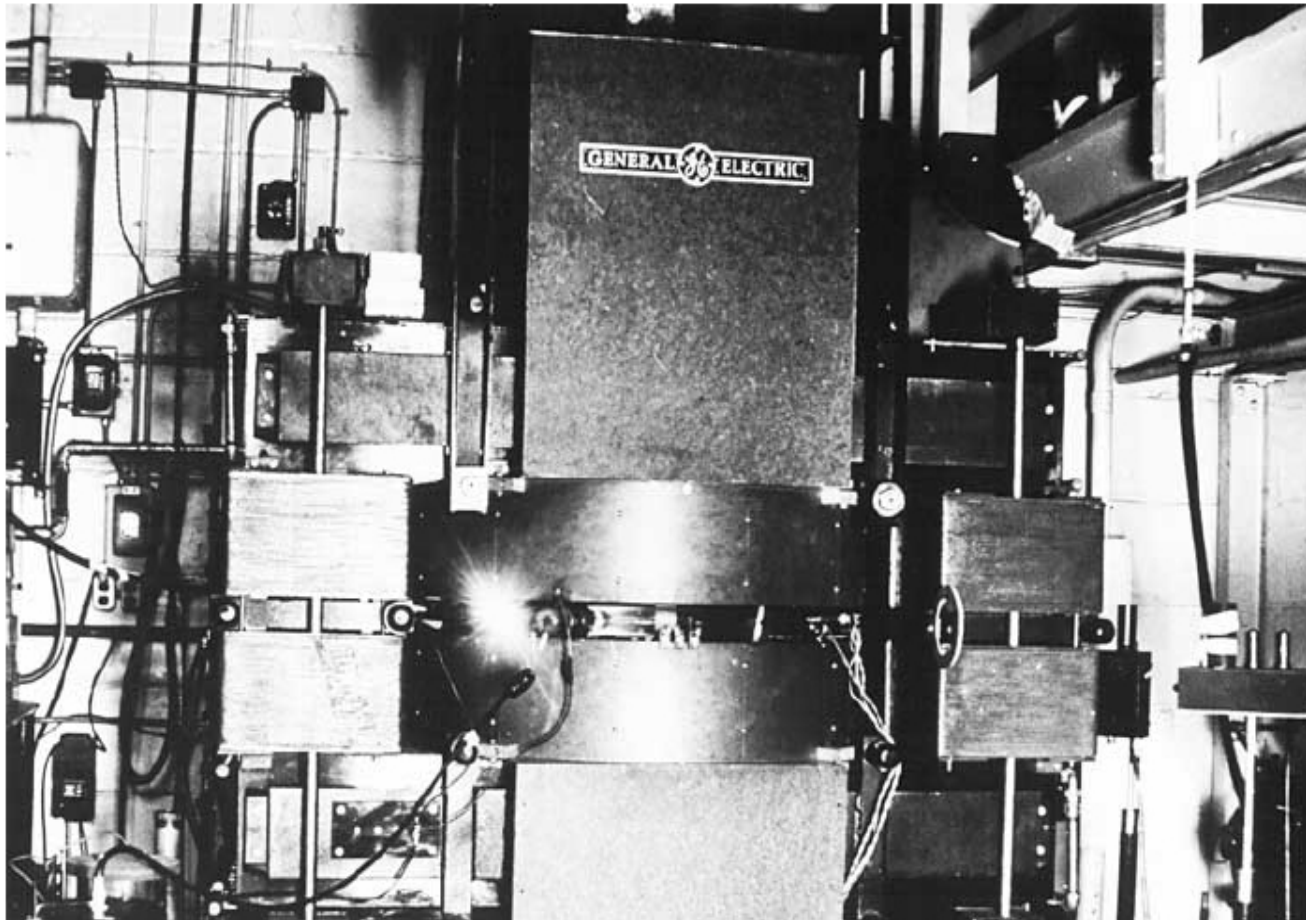

The 300 MeV electron synchrotron built at General Electric Co. in 1940s. The photograph shows the synchrotron radiation emitted from the accelerator.



# NSLS2, BNL

## Brand new, just started



# A ring FEL

- **The ring** is similar to, *or just is*, a ring light-source.
- The FEL undulator and mirror cavity are inserted in a straight section in the ring
- An complex evolution of the ring FEL, with even higher brilliance, is the “**optical klystron**”

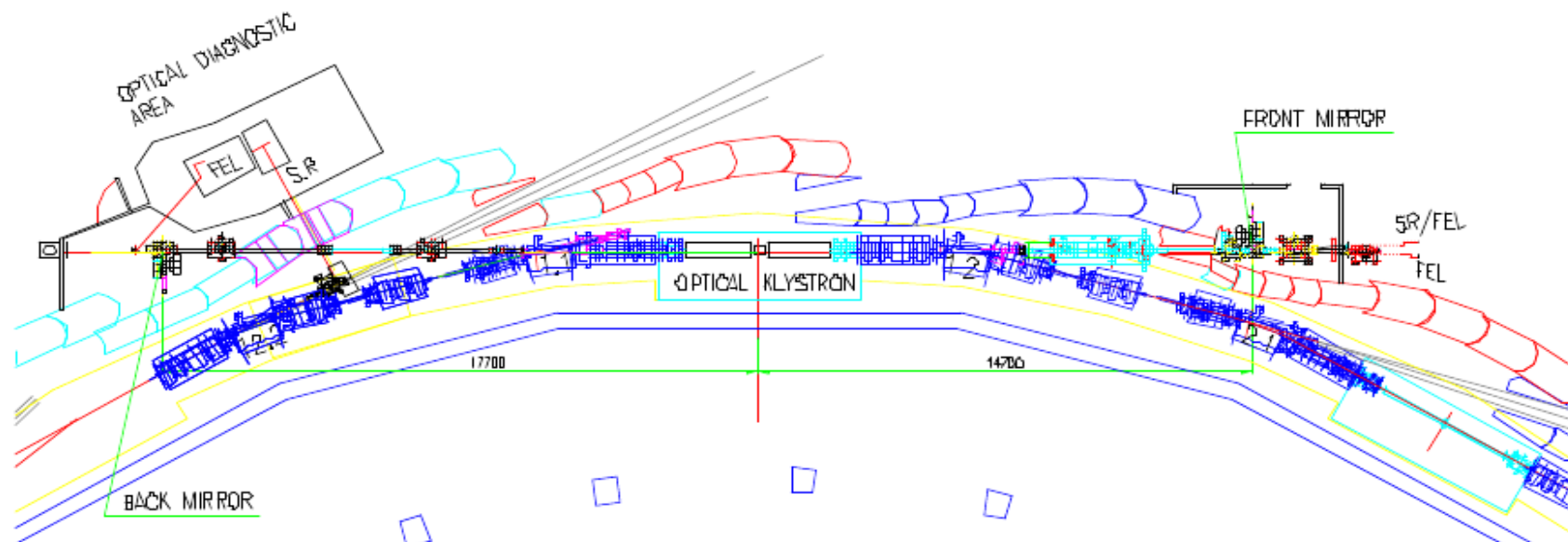
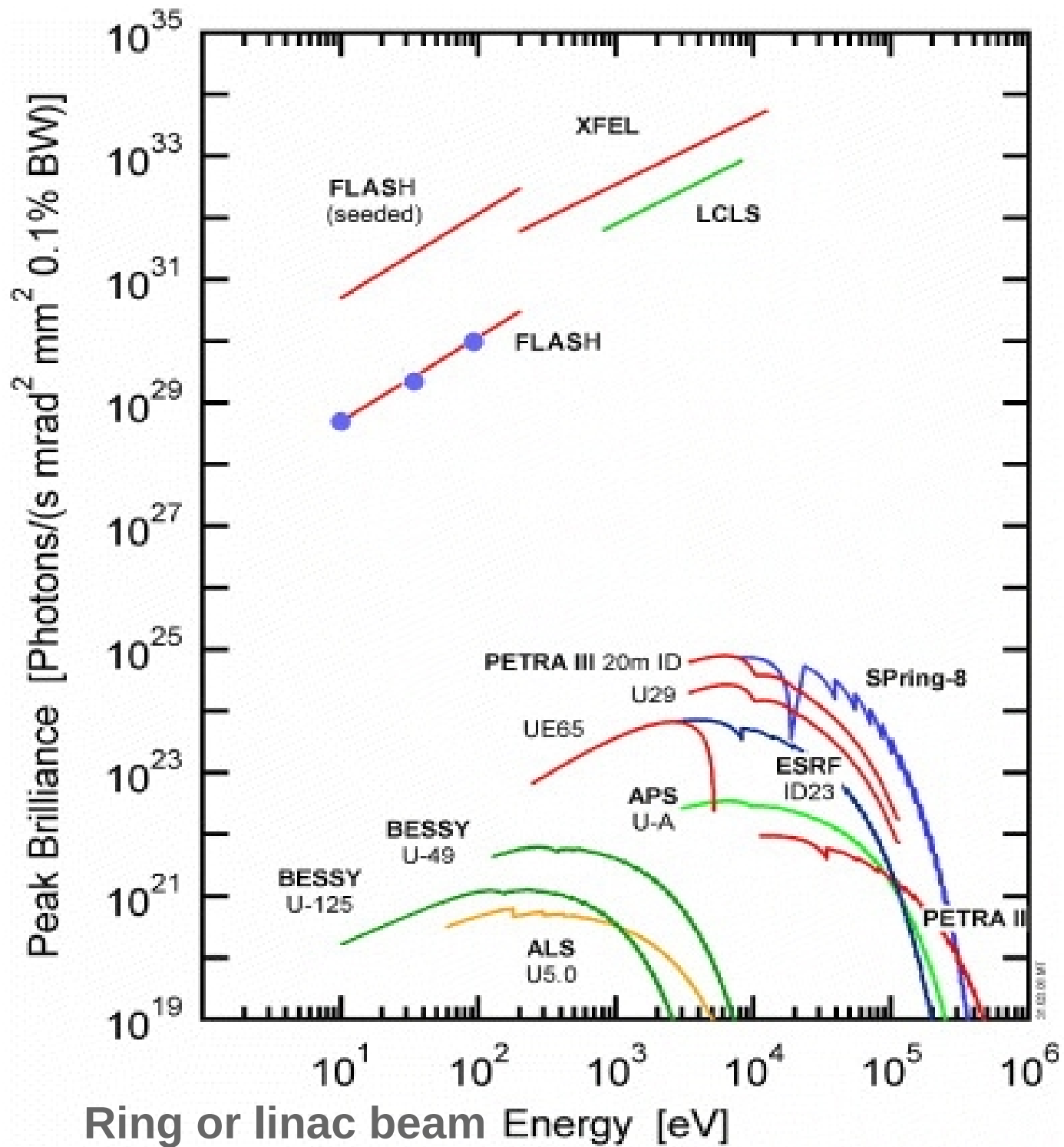

Figure 1: Layout of the Free-Electron Laser in the ELETTRA storage ring.



# HEP

**There are 2  
LARGE COLLIDERS LEFT  
ON THIS PLANET  
(*duno about other planets :)*)  
- *hadron colliders, rings* -**



# COLLIDERS

## - A LONG HISTORY, TOO

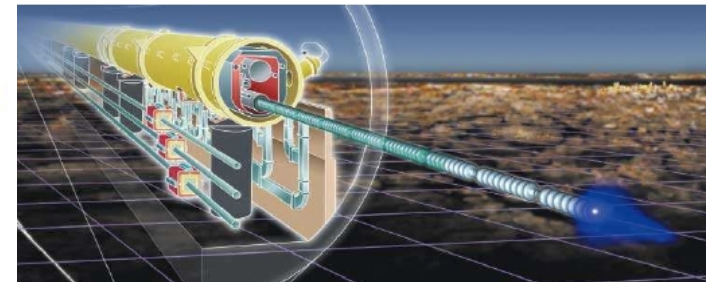
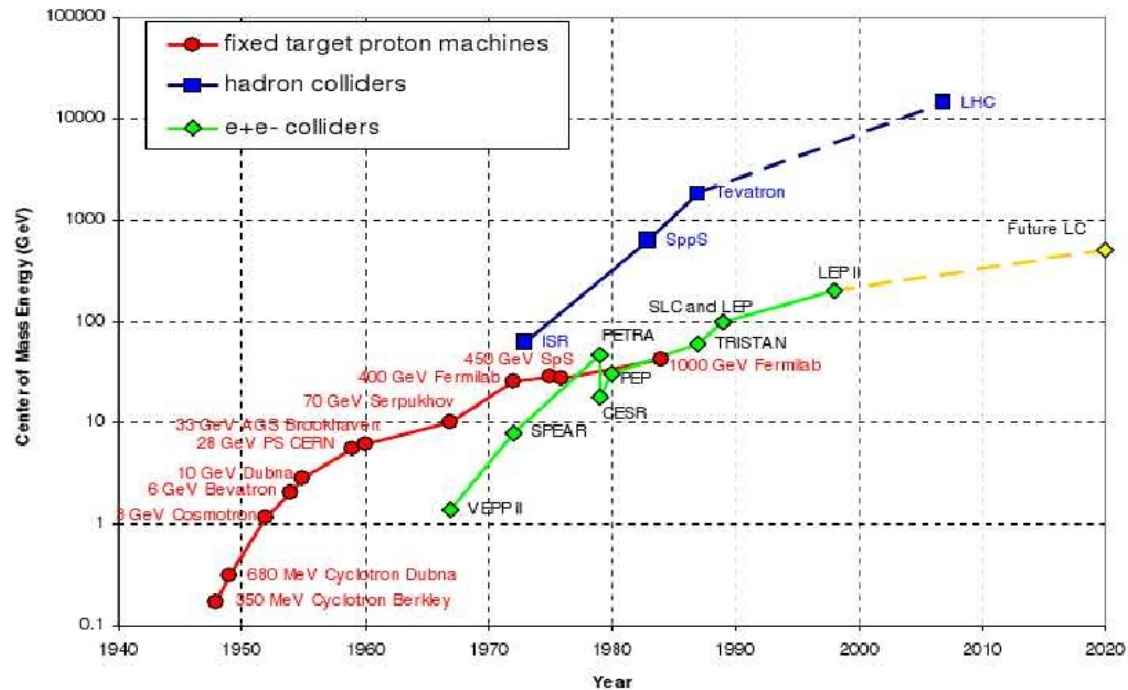

- The CM energy available in a collision between two particles, (1), (2), writes

$$E_{CM} = \sqrt{M_1^2 + M_2^2 + 2M_1M_2\gamma_1\gamma_2(1 - \beta_1\beta_2)}$$

- Considering particles with the same mass  $M$ , in fixed target collision mode, incoming beam with energy  $E$ , one gets

$$E_{CM} \approx \sqrt{2ME}$$

The energy available goes as the square root of the accelerator energy

- Considering particles with the same mass  $M$ , in collider mode, beams with respective energies  $E_1$ ,  $E_2$ , head-on collision, one gets

$$E_{CM} \approx 2\sqrt{E_1E_2}$$



# RHIC

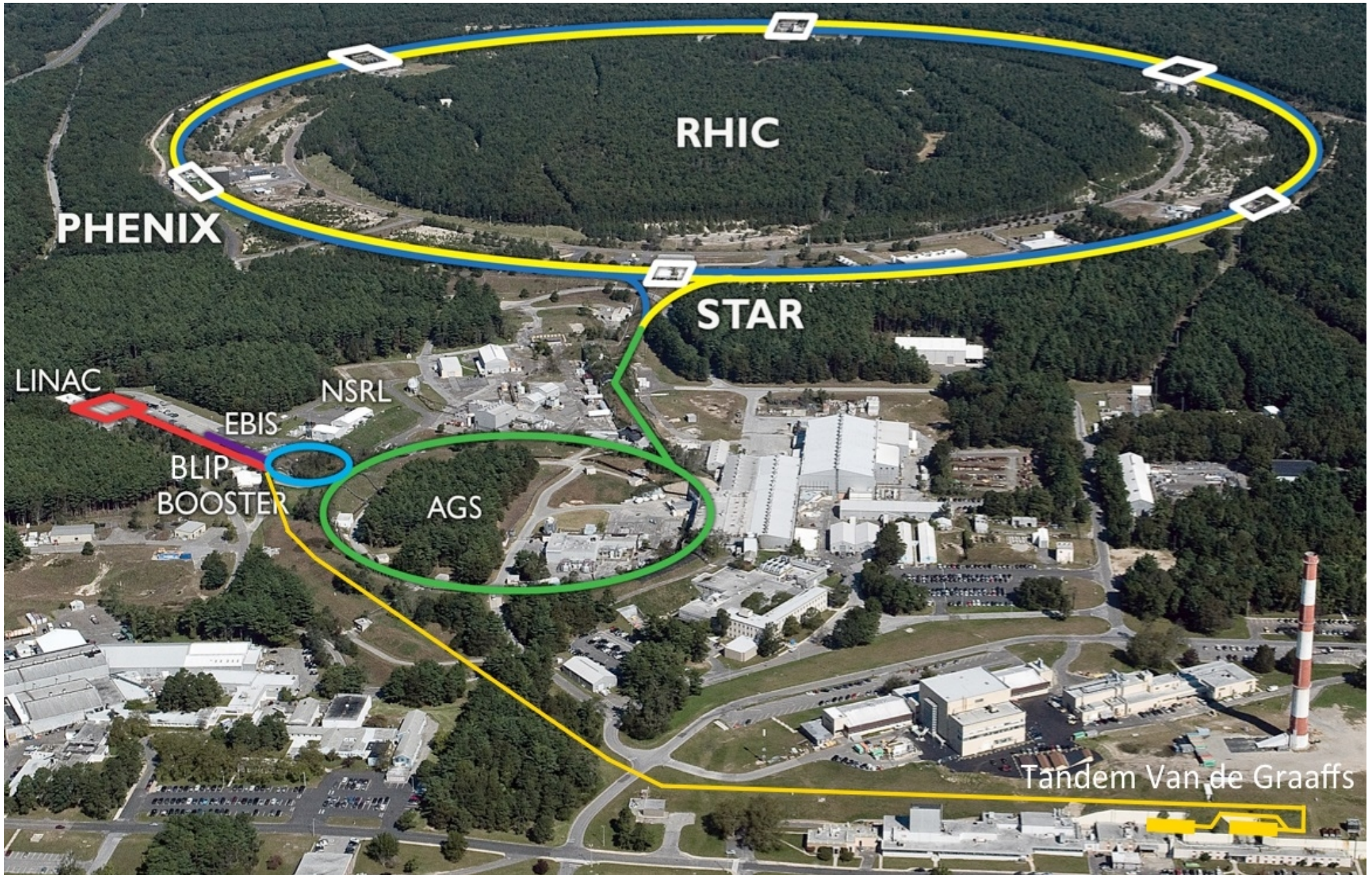



# RHIC

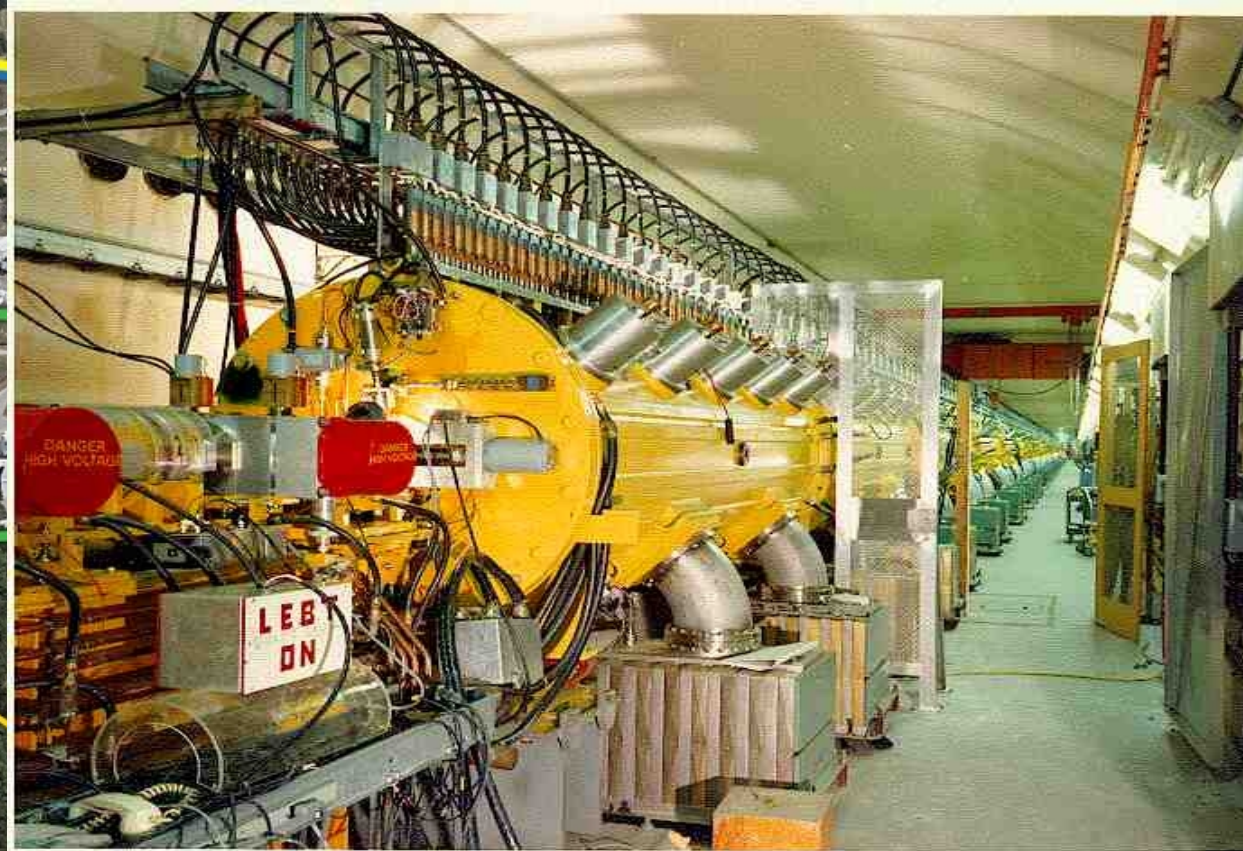
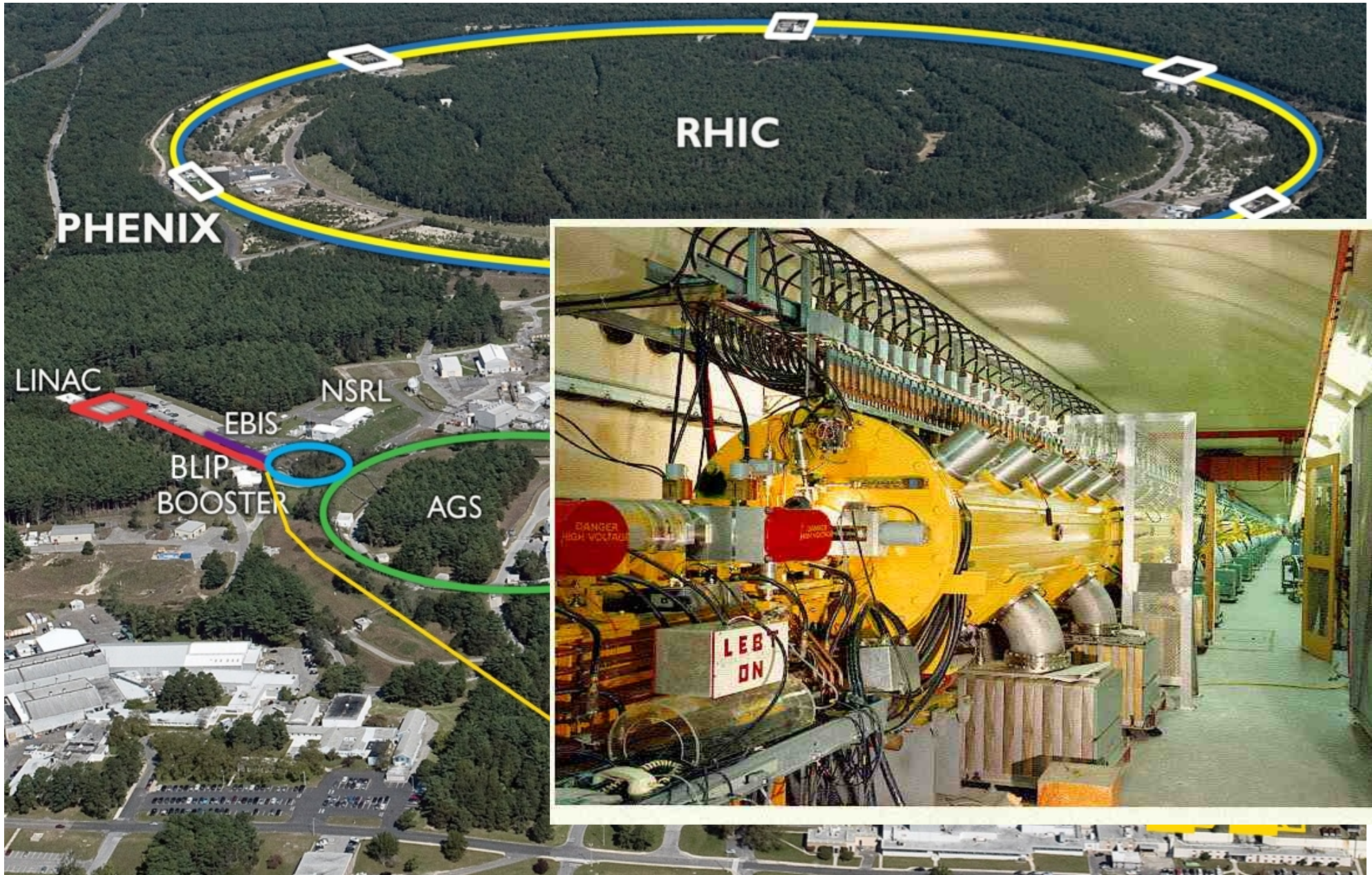





Tandem Van de Graaffs



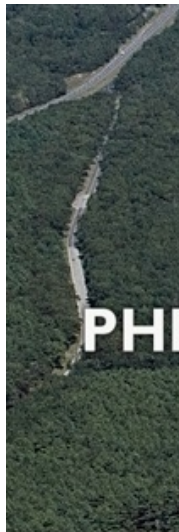
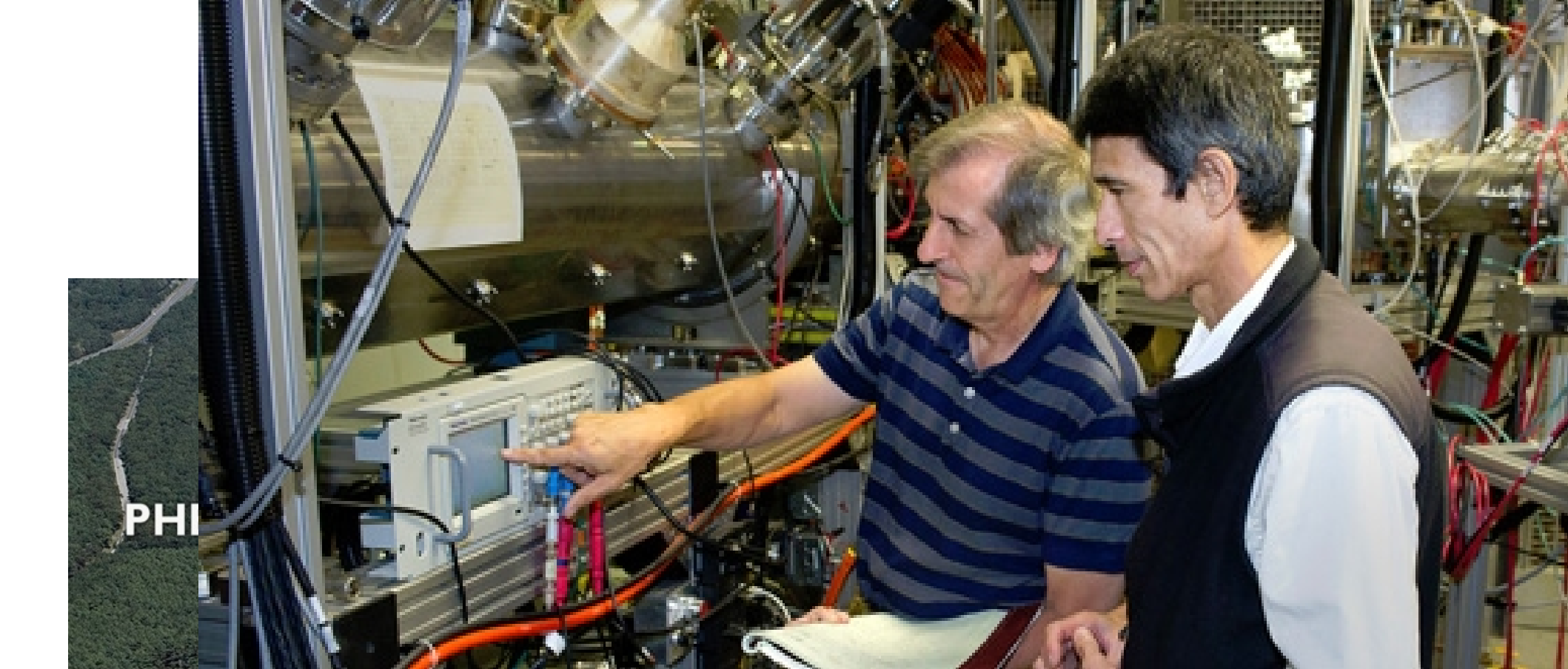

PHI

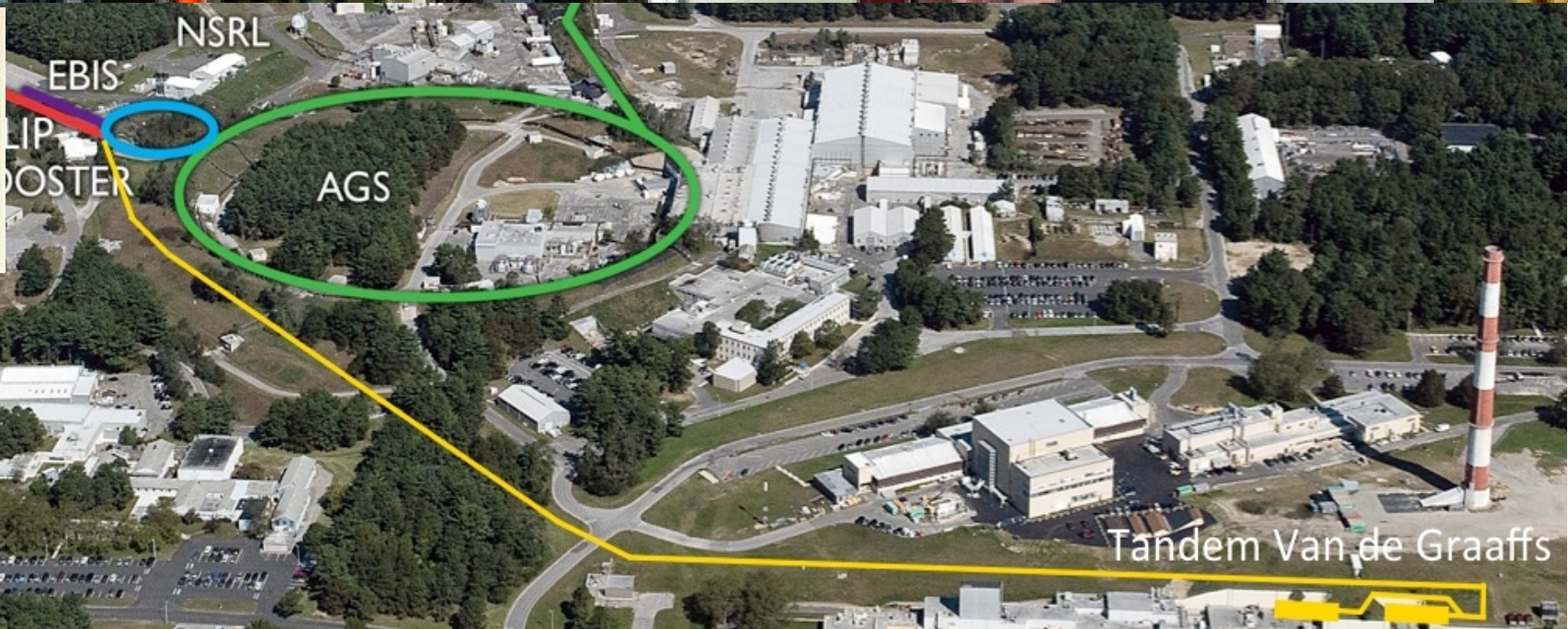
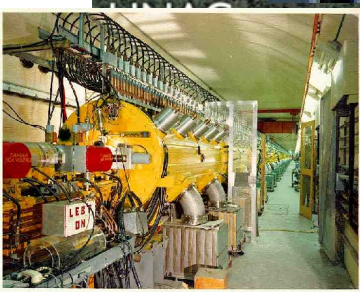

EBIS  
LIP  
OSTER

NSRL

AGS

Tandem Van de Graaffs



# RHIC

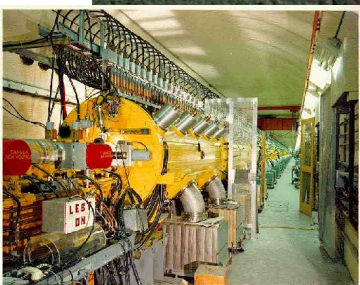
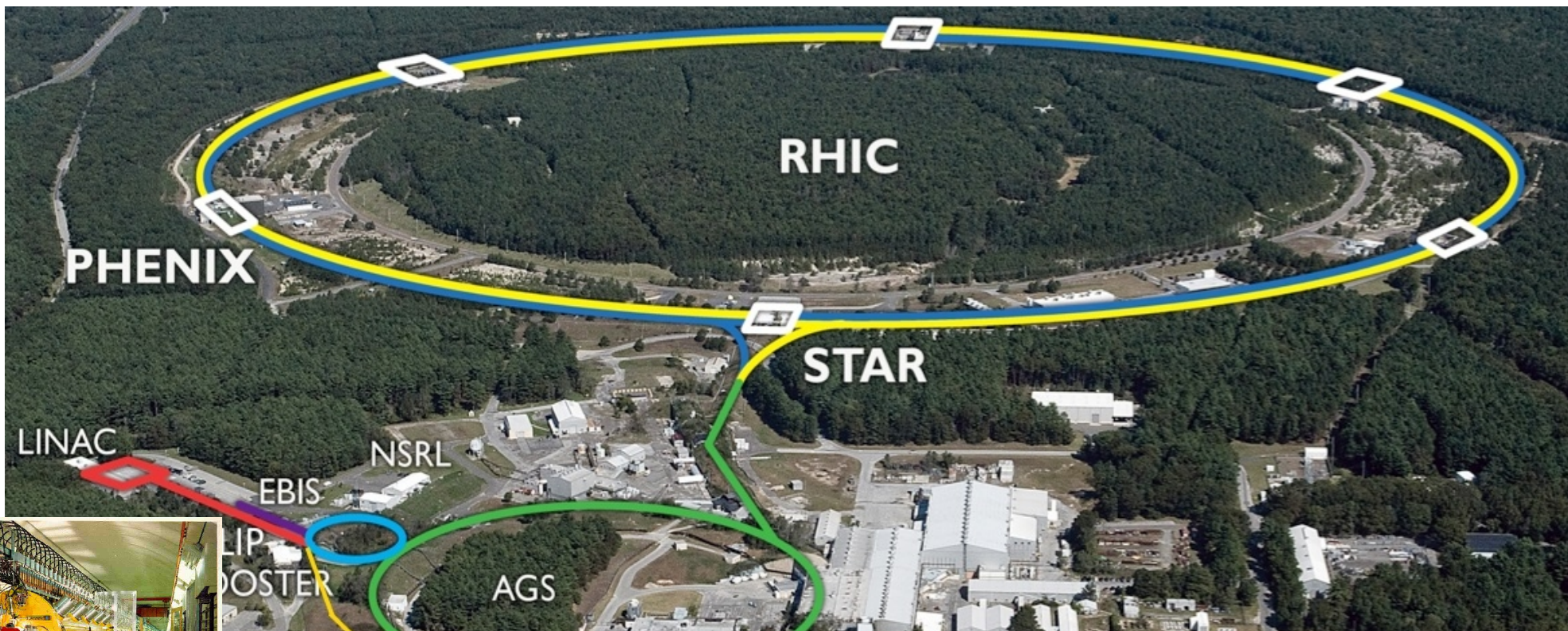





F  
LINA

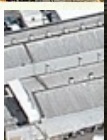

Tandem Van de Graaffs



# RHIC

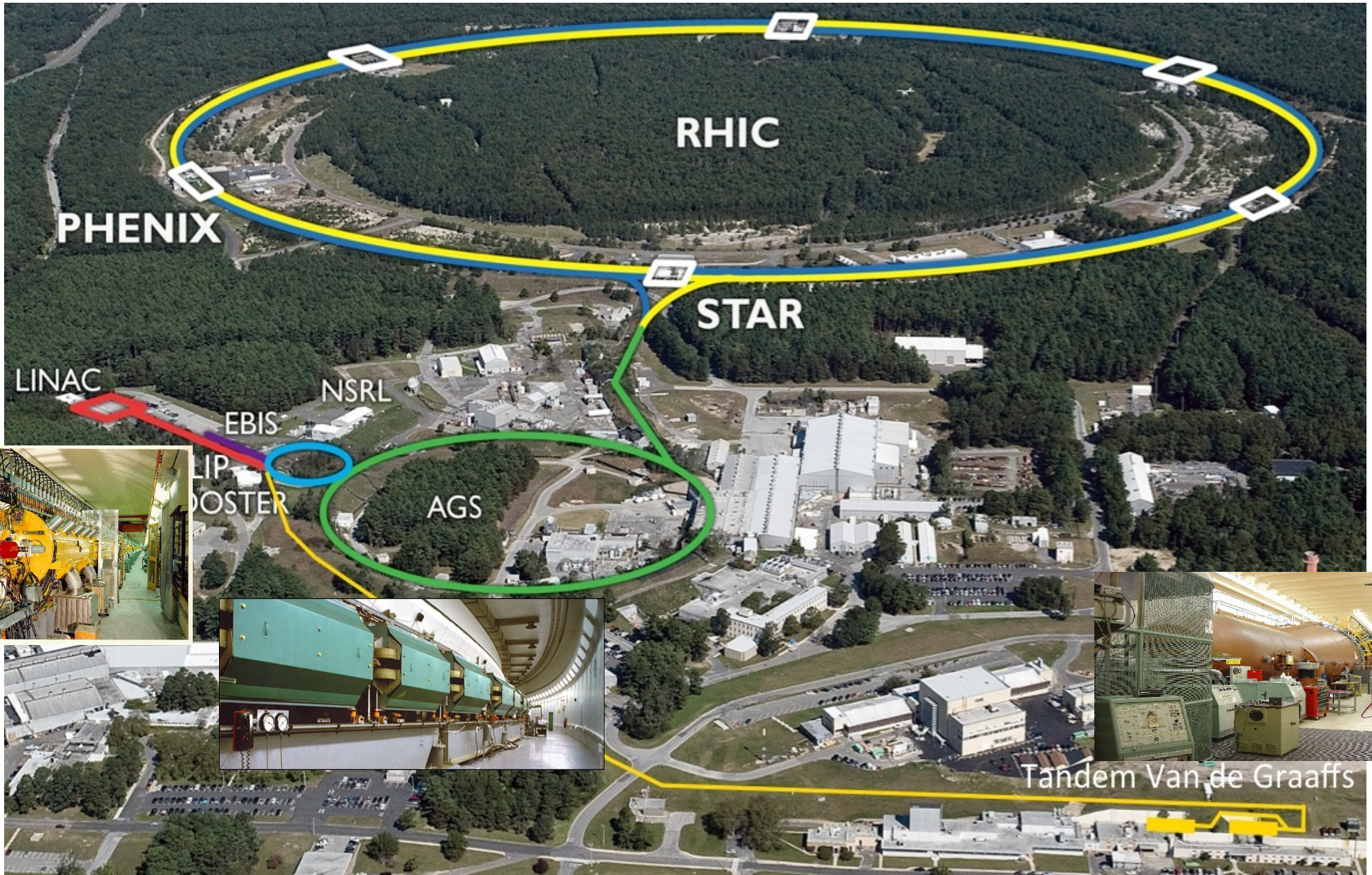



# The quark-gluon plasma created at RHIC collision points

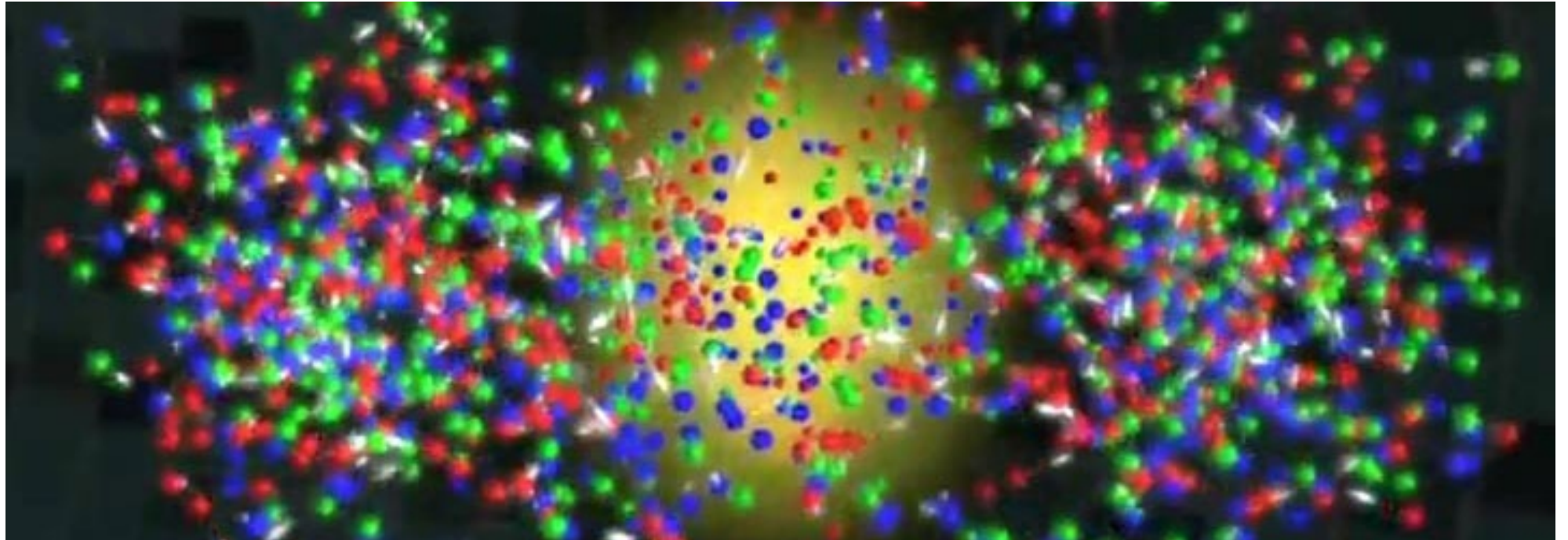



- “RHIC Run 15” is going on, Feb.-June
  - Physics is : polarized p-p 100GeVx100GeV
- Would you believe that :**
- **Machine availability is >90% !**
  - **10 km, thousands of super-duper high-tech equipments !**

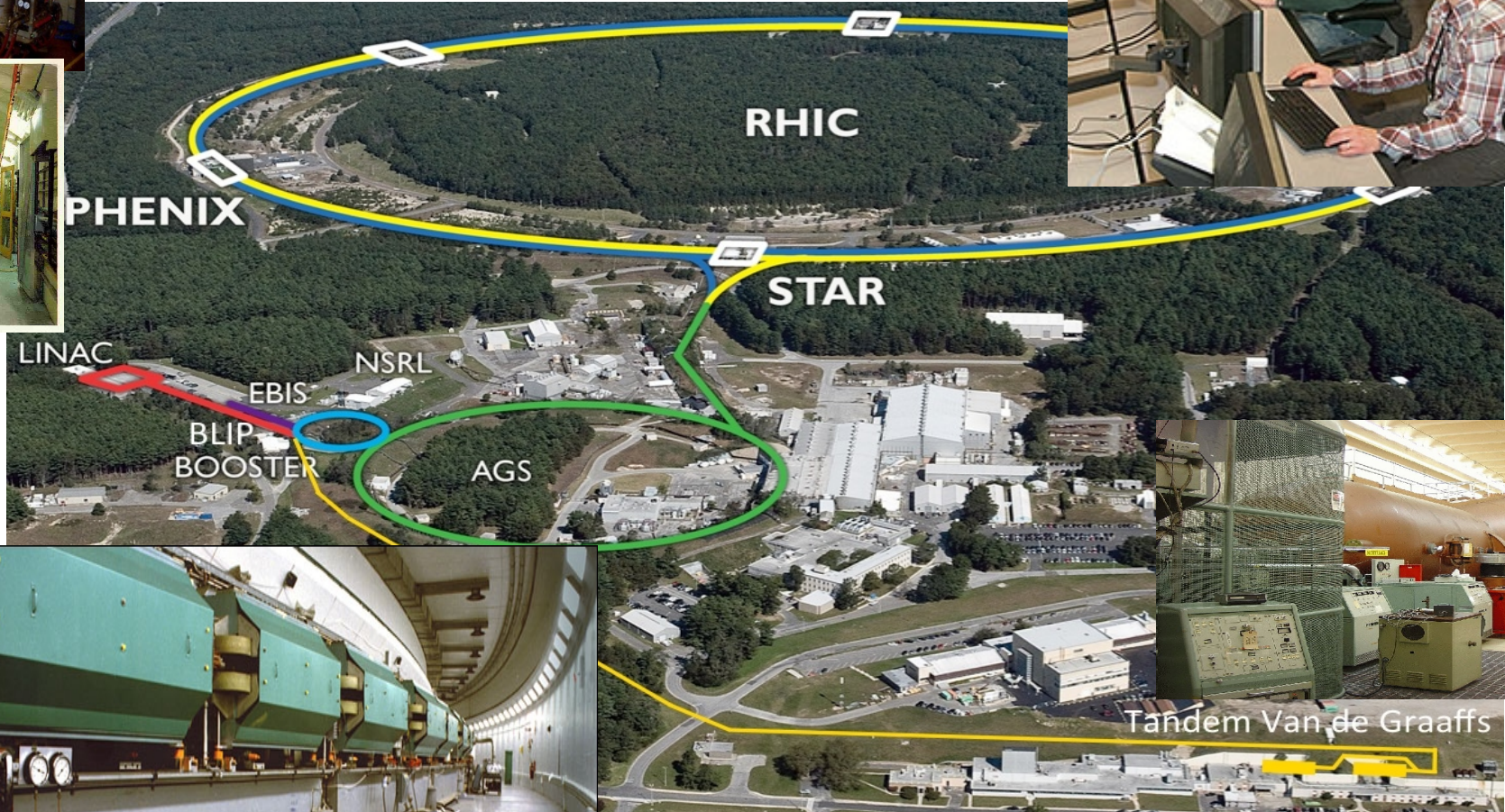

Tandem Van de Graaffs



# The largest : LHC

First run : 2009

Energy limited to 7 TeV

Discovery of Higgs Boson announced in 2012

Last two years : upgrades and repairs

Now restarting at 13 TeV

10,000 people from 113  
different countries  
contributed



# CERN's Accelerator Complex

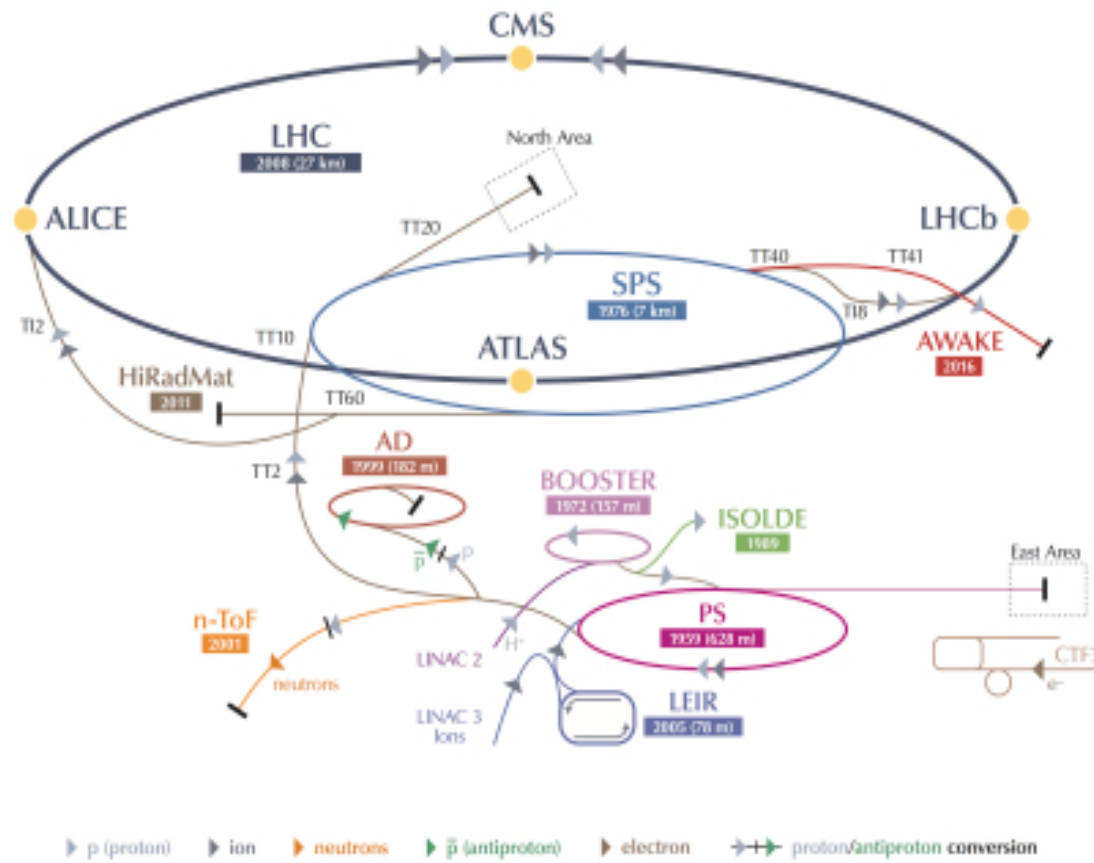

LHC Large Hadron Collider   SPS Super Proton Synchrotron   PS Proton Synchrotron

AD Antiproton Decelerator   CTF3 Clic Test Facility   AWAKE Advanced WAKEfield Experiment   ISOLDE Isotope Separator OnLine DEvice

LEIR Low Energy Ion Ring   LINAC LINear ACcelerator   n-ToF Neutrons Time Of Flight   HiRadMat High-Radiation to Materials

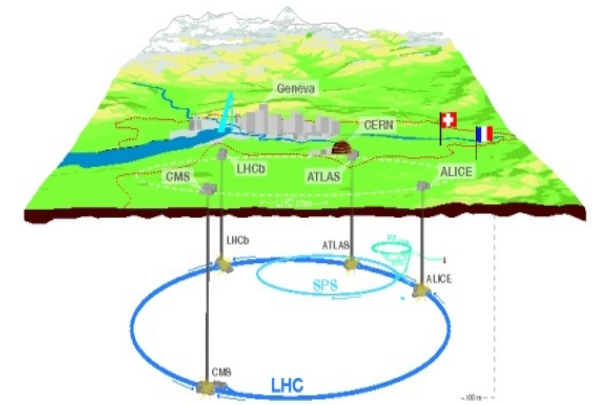

# LHC DIPOLE : STANDARD CROSS-SECTION

CEBN AC 02/03/04 - PS 107 - 02/04 2000

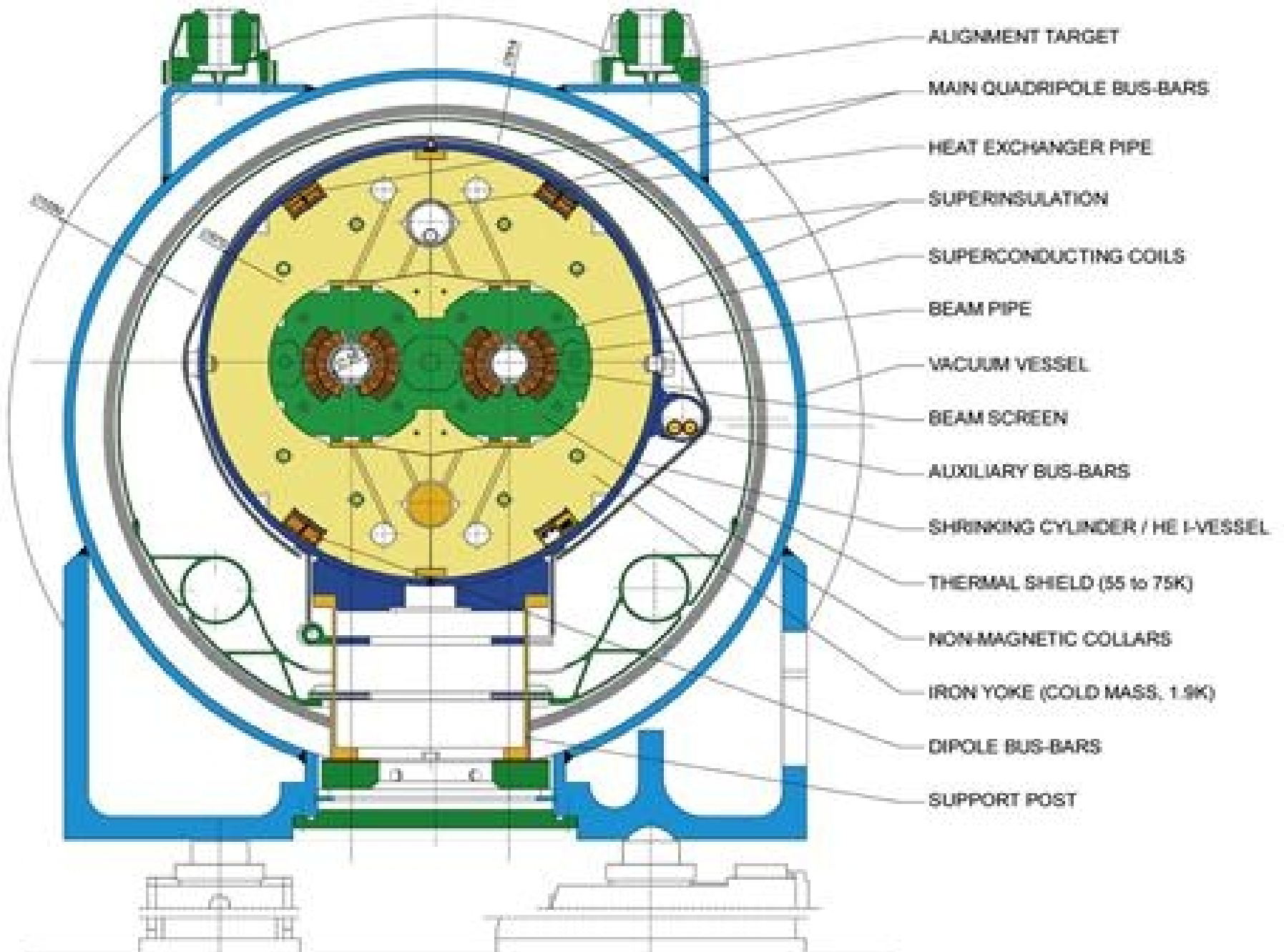







# SUPERCONDUCTING CAVITIES

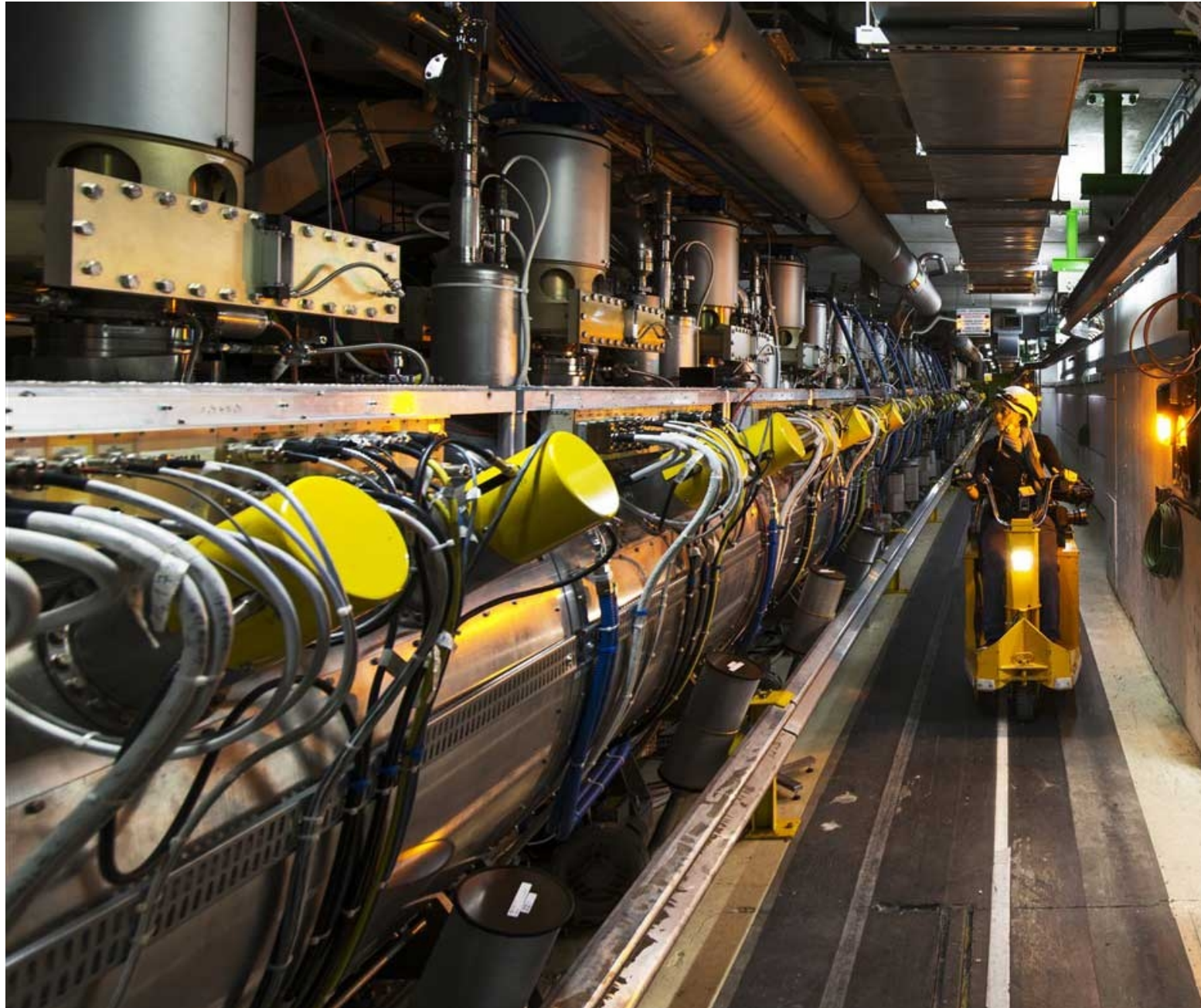





# ATLAS

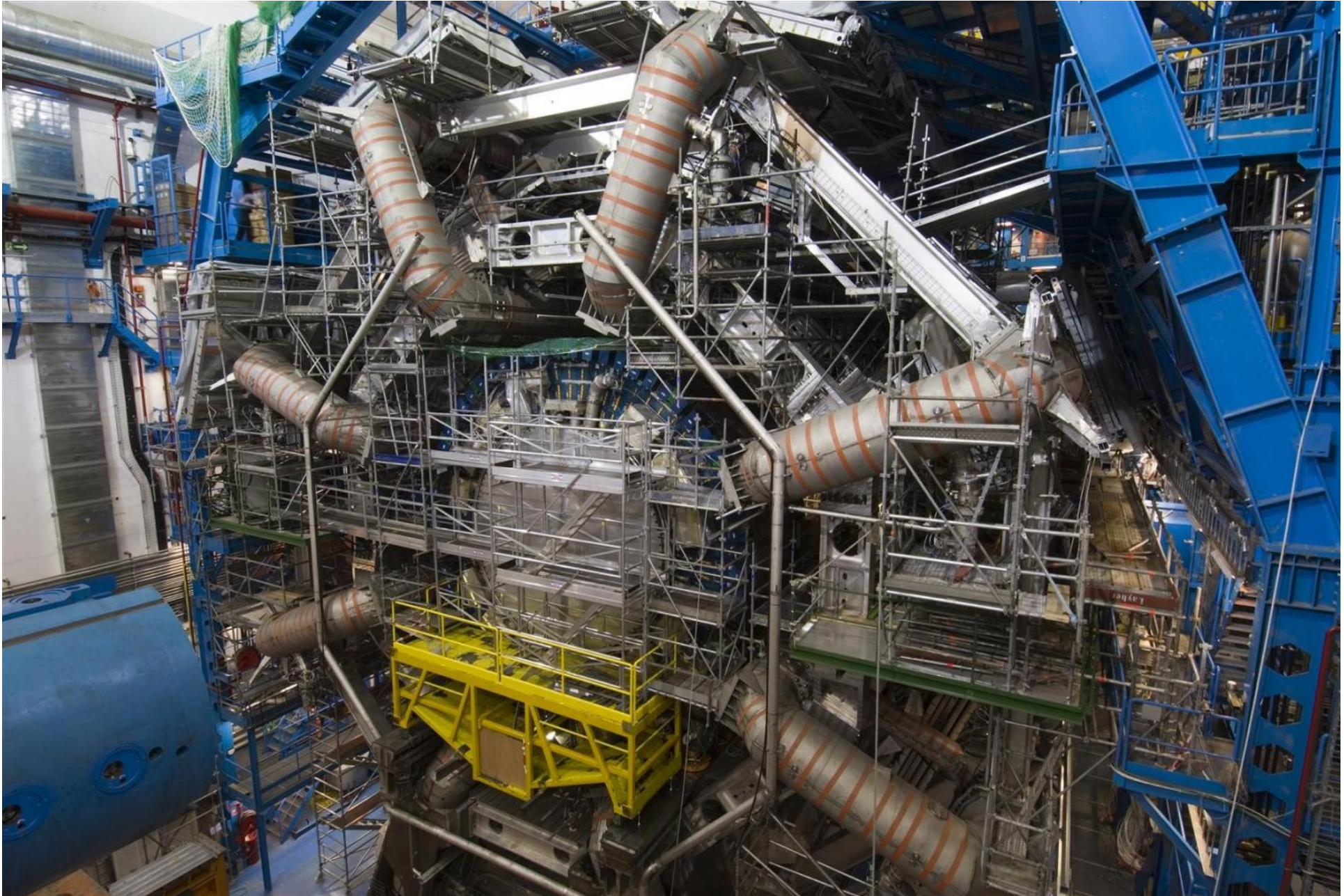



# CMS

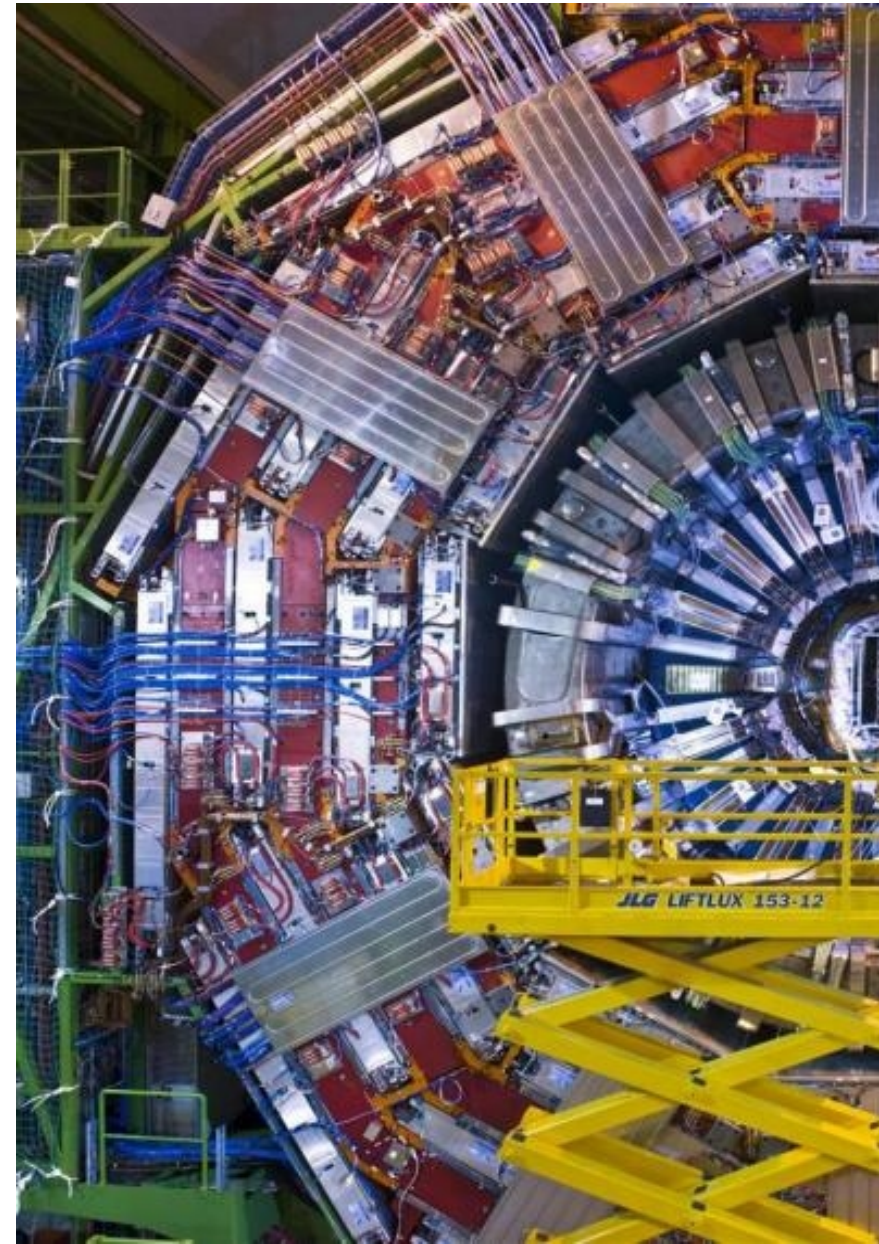



# ION BEAMS FOR HADRON-THERAPY

*AKA,*

***3-D CONFORMAL  
RADIATION-THERAPY***

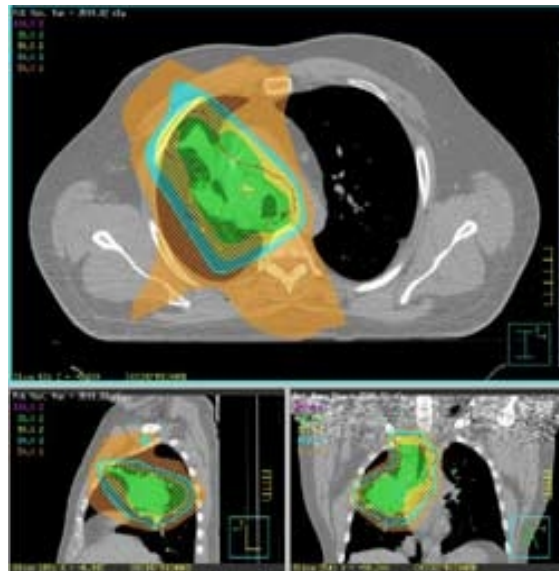



The accelerator in this application is,

proton-therapy :

- generally a cyclotron
- in some treatment centers a  
synchrotron

carbon-therapy :

a synchrotron

# The maths-physics behind

- Linear energy transfer

$$dE/dx \sim Z^2$$

$$\text{e.g., } dE_{dx\_C}/dE_{dx\_p} = 6^2 = 36$$

- The Bragg peak ballistics

$$\text{range} \sim A/Z^2$$

$$\text{e.g., } R_C/R_p = A_C Z_p^2 / A_p Z_C^2 = 12/36 = 1/3,$$

for the same energy (MeV/u), p penetrates 3 times deeper

# Advantages of the bragg-peak ballistic

- this is by comparison with X-ray therapy -

- Better sparing of healthy tissues - competitive with IMRT

## On the other hand

- big investment, e.g., of the order of EU150M for a turn-key carbon-therapy hospital,
- High cost of a session : of the order of EU600 per session, ~3x cost of an IMRT session.  
~EU20k per treatment



# FACTORIES

- PHOTON FACTORIES
  - PHI FACTORIES
  - NEUTRINO FACTORIES
  - SUPER-B
  - ETA FACTORIES
- 
- THAT TAKES BACK TO THE ORIGIN OF ACCELERATORS, EARLY 20TH CENTURY: PRODUCE COLLIMATED BEAMS OF PARTICLES OTHERWISE TO BE CATCHED, SCARCELY, FROM COSMIC RADIATION

# IN CONCLUSION

## THIS RUSH TOWARD ACCELERATOR SCIENCE AND TECHNOLOGY KEEPS RAMPING UP ! SEEMS TO NEVER BE WILLING TO STOP !

- CORNELL LABORATORY FOR ACCELERATOR-BASED SCIENCES AND EDUCATION — CLASSE
- [Home / NewsAndEvents / IEBWorkshop](#)
- Registration will close on May 31, 2015.
- With the advent of high power photoinjectors and high performance superconducting RF acceleration, there is the potential for low energy electron beams with **currents up to 10 times higher than those generally available today**. This workshop will explore the physics opportunities that will be opened up by such beams, focusing on **parity violation, the search for dark photons, and electromagnetic nuclear physics**, as well as the accelerator, detector, target and polarimetry technologies that make them possible. Discussion will focus on electron beams with energies up to 500 MeV and electron current of up to 100 mA (unpolarized) and 10 mA (polarized) with energy recovery, with the goal of answering:
  - What is the **potential reach of experiments using very intense low energy electron beams**?
  - What **technical challenges** need to be overcome to reach those goals?