

# CYCLOTRON

- ORIGINS
- BASIC PRINCIPLES
- CYCLOTRONS TODAY

In real life...

# 184 inch cyclotron at Berkeley, ~1940

(would later evolve to 730MeV synchrocyclotron, 1946 )



# A model of TRIUMF 520 MeV H- cyclotron (the largest)

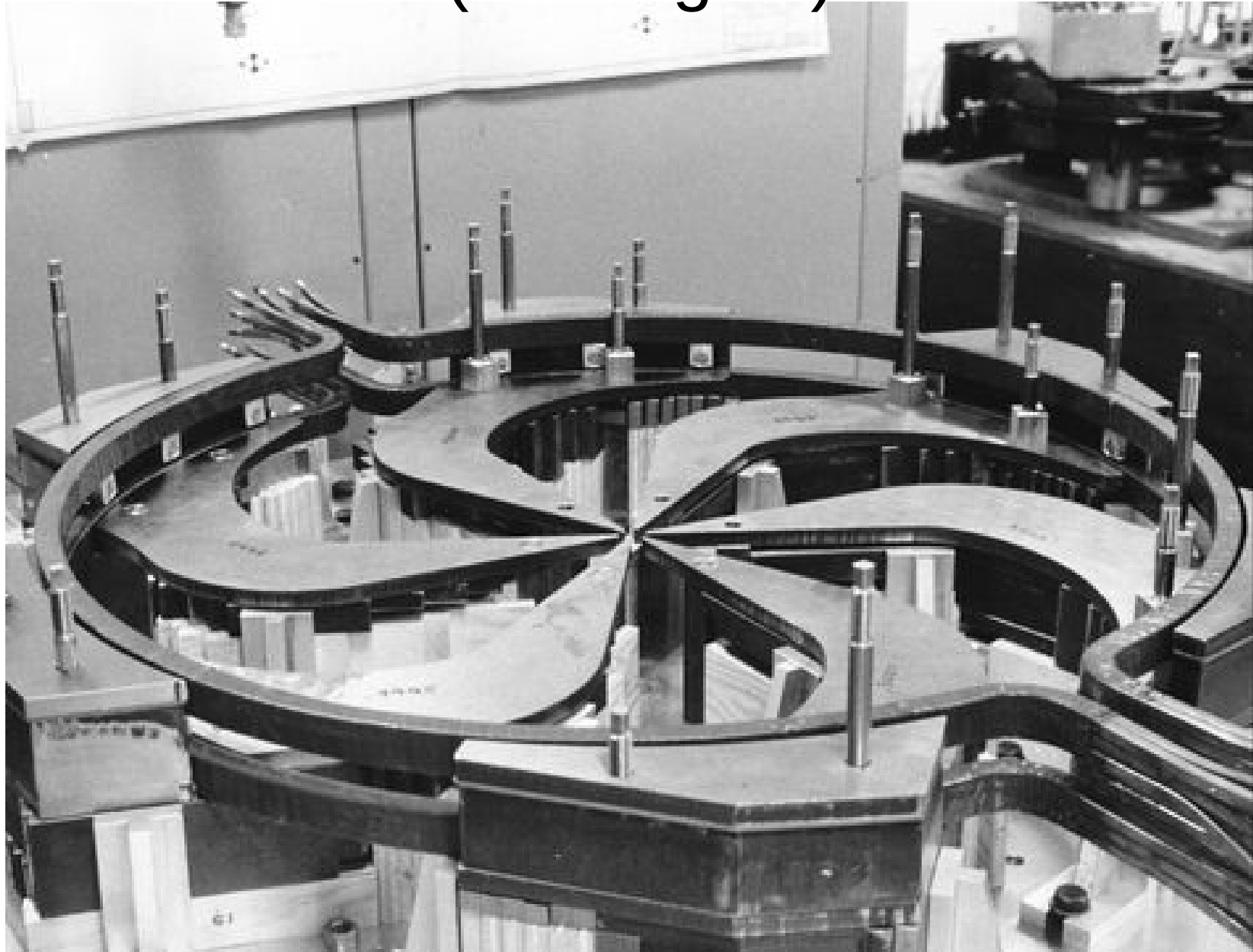

...and for real !



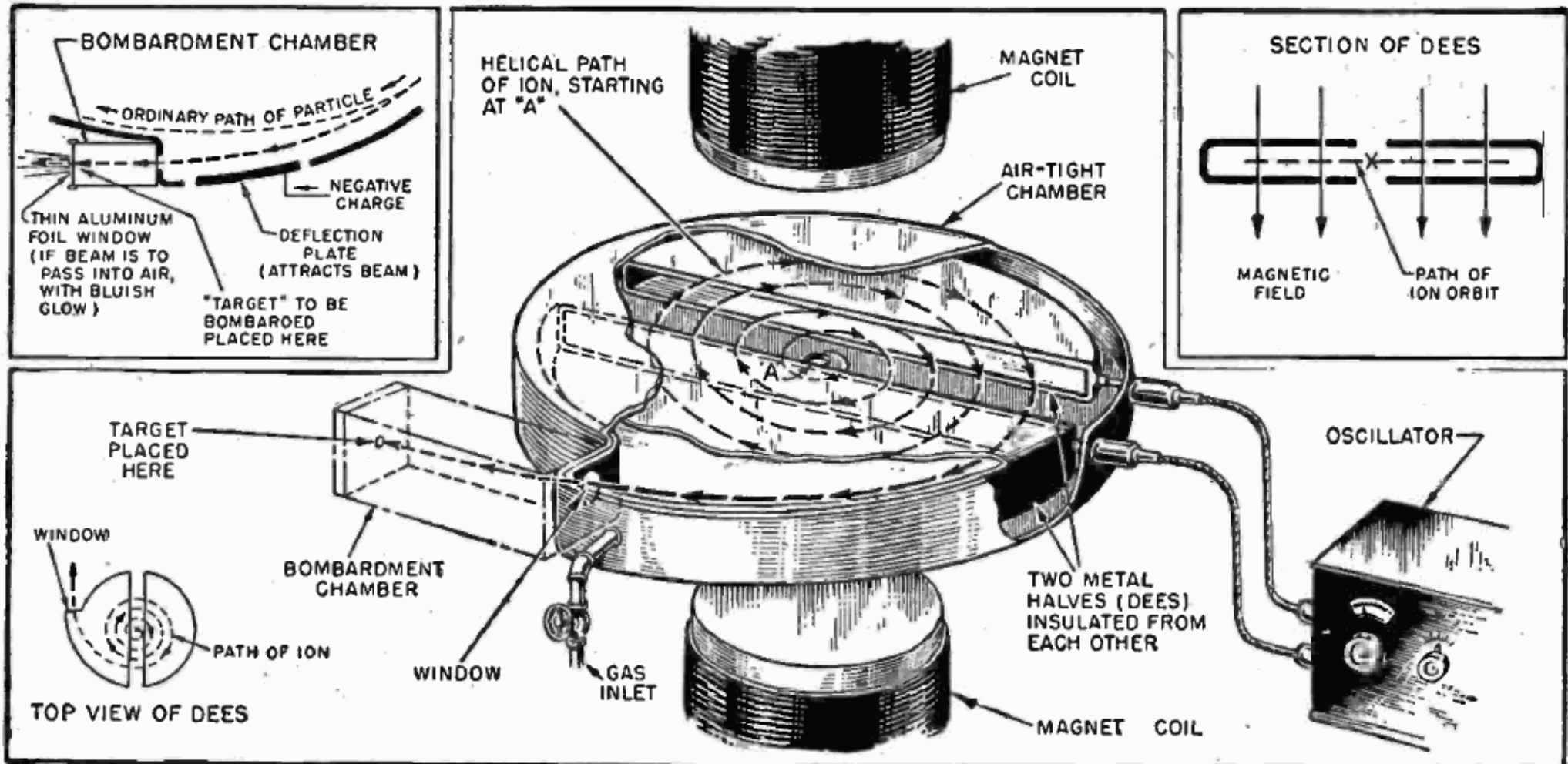

- The idea and theory of the cyclotron goes back to Max Steenbeck, PhD, Kiel, 1927. Leo Szilard patented the concept of bending+RF acceleration in 1929 [A.Sessler,E.Wilson].

## Cyclotron (1/5)

- 1929-1930, Ernest O. Lawrence inspired by Wideroe & Ising ideas invents (the principle of) the cyclotron : having read Wideroe's paper, he speculated on the use of a magnetic field to bring the particle back to a *single* accelerating gap next to acceleration.

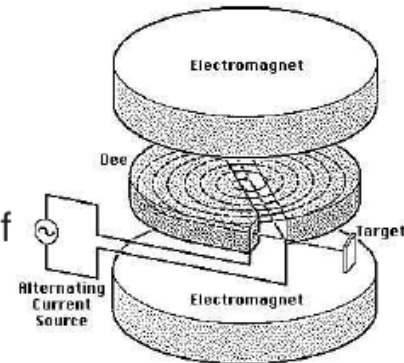

- Doing so he found that the revolution frequency in uniform B is constant : the “cyclotron angular frequency”,  $\omega_0 = qB/m$
- That allows RF gap voltage at constant frequency,  $f_{RF} = qB / 2\pi m$ .

- 1931, Stanley Livingston, Berkeley, demonstration with 5-inch cyclotron by acceleration of hydrogen ions up to 80 KeV (about 40 turns up to  $r \approx 4.5$  cm).
- 1932,  $\phi 30$  cm cyclotron built by Lawrence produces protons at 1.25 MeV and breaks atoms *a few weeks after Cockcroft-Walton's Li + p*
- 1934, Berkeley, E.O. Lawrence builds a 27-inch cyclotron, accelerates protons to 3 MeV and D to 5 MeV
- 1939, E. O. Lawrence receives the Nobel Prize “for the invention and development of the cyclotron and for results obtained with it, especially with regard to artificial radioactive elements”.

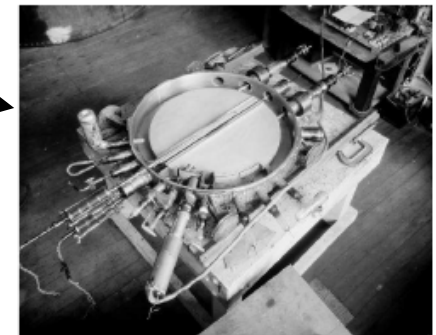
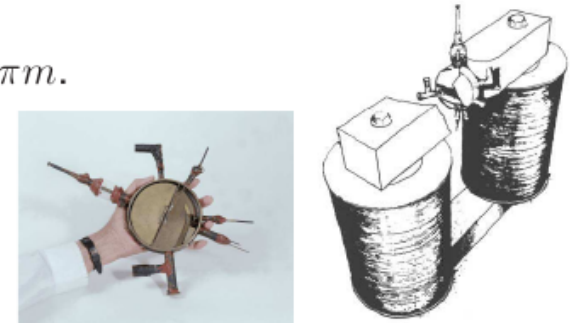

- That was just the beginning of a lasting story, yet...

The device is inserted in the gap of an electromagnet.

*Ref.:*  
*wikipedia*

- E.O. Lawrence 27 inch cyclotron, 1932.
- The ensemble on the photo is plunged in the gap of an electromagnet
- 13,000 V RF accelerating potential at about 27 MHz is applied to the dees by the two feedlines visible at top right.
- Beam emerges from the dees and strikes the target in the chamber at bottom.

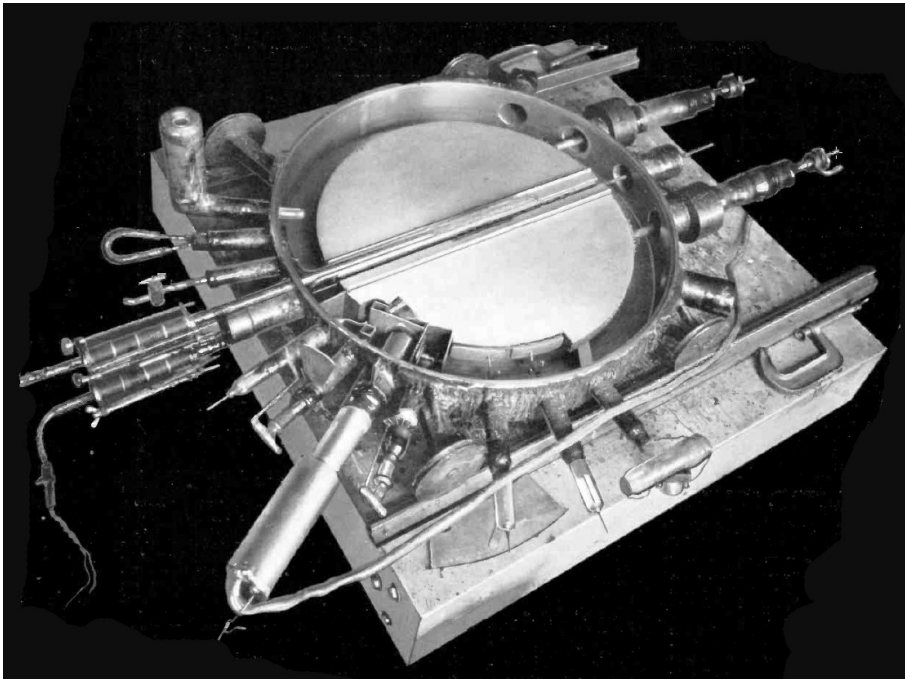

- 60-inch cyclotron, ~1939
- Exiting beam of accelerated ions ionize the air.

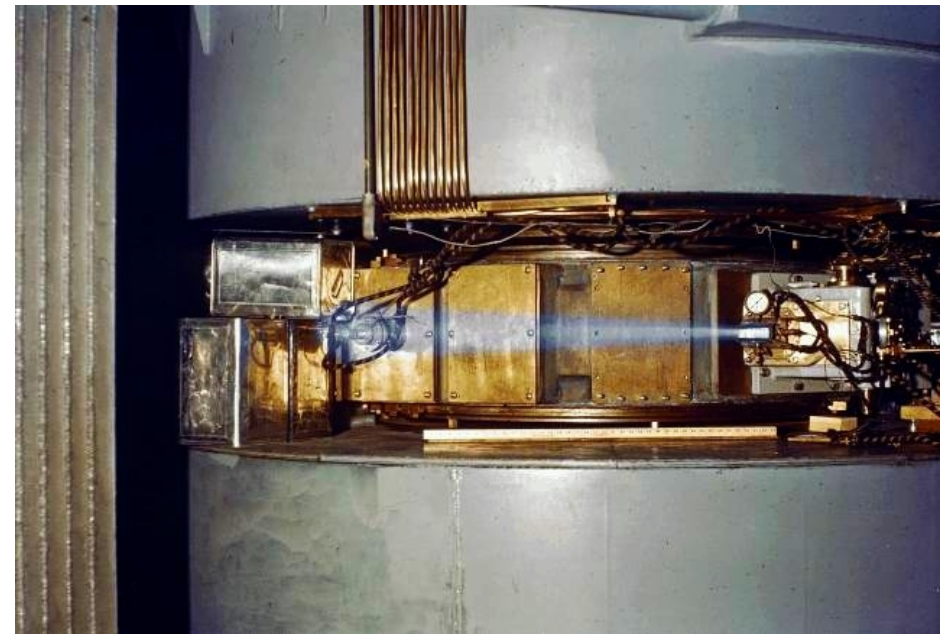

# CLASSICAL CYCLOTRON

## Cyclotron (2/5) - classical

- Non-relativistic cyclotron

- orbit :  $r = v/\omega_0 = mv/qB$

- focusing (1) :

$$F_z = qvB_r \approx qv \frac{\partial B_r}{\partial z} \equiv qv \frac{\partial B_z}{\partial r}$$

$$\ddot{z} - \frac{qv}{m} \frac{\partial B_z}{\partial r} = 0 \rightarrow \omega_z^2/\omega_0^2 = \nu_z^2 = -\frac{r}{B_z} \frac{\partial B_z}{\partial r} = -k, \quad \nu_z = \sqrt{-k}$$

hence the field index  $k$  needs be negative :  $B_z$  is slowly decreased with radius.

Similarly,  $\nu_r = 1 + k$ . This sets the requirement  $-1 < k < 0$

- focusing (2) : is also ensured at lower energy by the electric field.

- isochronism :

The condition for vertical focusing,  $-1 < k < 0$  ( $B$  is not constant), spoils the isochronism.

As a consequence, the phase is not constant (ABCDE path)

- bunching : particle beam injected into the cyclotron necessarily gets bunched, at the frequency of the RF (the time interval between two bunches is an RF period)

- The classical limit ( $\gamma \approx 1$ ) is  $\sim 25$  MeV for protons, 50 MeV for D and  $\alpha$ , (about 2 – 3% increase in mass), GANIL in Caen accelerates Carbon to about 100 MeV/u...

- That was enough energy to transmute all nuclei... The classical cyclotron allowed discovering oodles of nuclear reactions and isotopes.

Yet, let's keep in mind : transmutation was not the all story

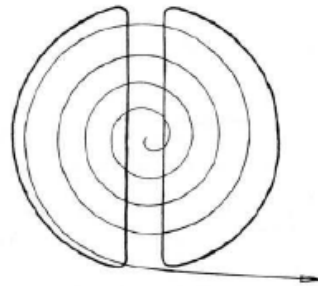

With  $B$  constant in time and uniform in space, as particles gain energy from the rf system, they stay in synchronism, but spiral outward in  $r$ .

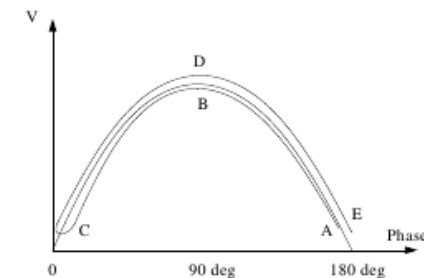
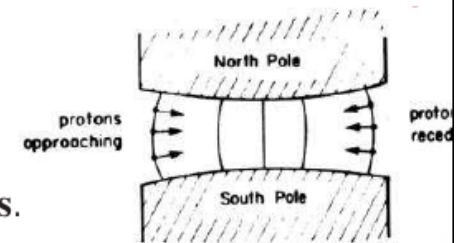

Ecole accélérateurs,

protons



# THE END OF THE STORY...

## Cyclotron (3/5) - classical

- Relativistic energies, the bad news :

- The cyclotron resonance  $\omega_0 = qB/\gamma m$ , with  $r = \beta c/\omega_0$  yields  $k = \frac{\beta}{\gamma} \frac{\partial \gamma}{\partial \beta} = \beta^2 \gamma^2$

- so  $k$  cannot satisfy  $-1 < k < 0$ ,

isochronism requires that  $B(r) \propto \gamma$ , which yields vertical defocusing...

- That was the end of the story,  $\sim 25$  MeV protons, etc... :

Hans Bethe (1937) :

“... it seems useless to build cyclotrons of larger proportions than the existing ones... an accelerating chamber of 37 cm radius will suffice to produce deuterons of 11 MeV energy which is the highest possible...”

Frank Cole : “If you went to graduate school in the 1940s, this inequality ( $1 < k < 0$ ) was the end of the discussion of accelerator theory.”

- Until...

# ISOCHRONOUS CYCLOTRON

## Cyclotron (4/5) - Thomas focusing

- 1938, L.H. Thomas, "The Paths of Ions in the Cyclotron", introduces the "Thomas focusing", based on separate sector bending, namely, "edge-focusing",
- 1954, Kerst, spiral edges increase vertical focusing further  

$$\nu_z = \sqrt{-k + F^2(1 + 2 \tan^2 \xi)}$$

$$F = \text{Flutter } 8.13 \frac{\langle B^2 \rangle - \langle B \rangle^2}{\langle B \rangle^2}$$
- That allowed having  $B(r)$  increase in proportion to  $\gamma$ , so to ensure constant RF frequency ( $\omega_0 = qB/\gamma m$ ), while *preserving vertical focusing*.
- Modern cyclotrons still rely on these principles

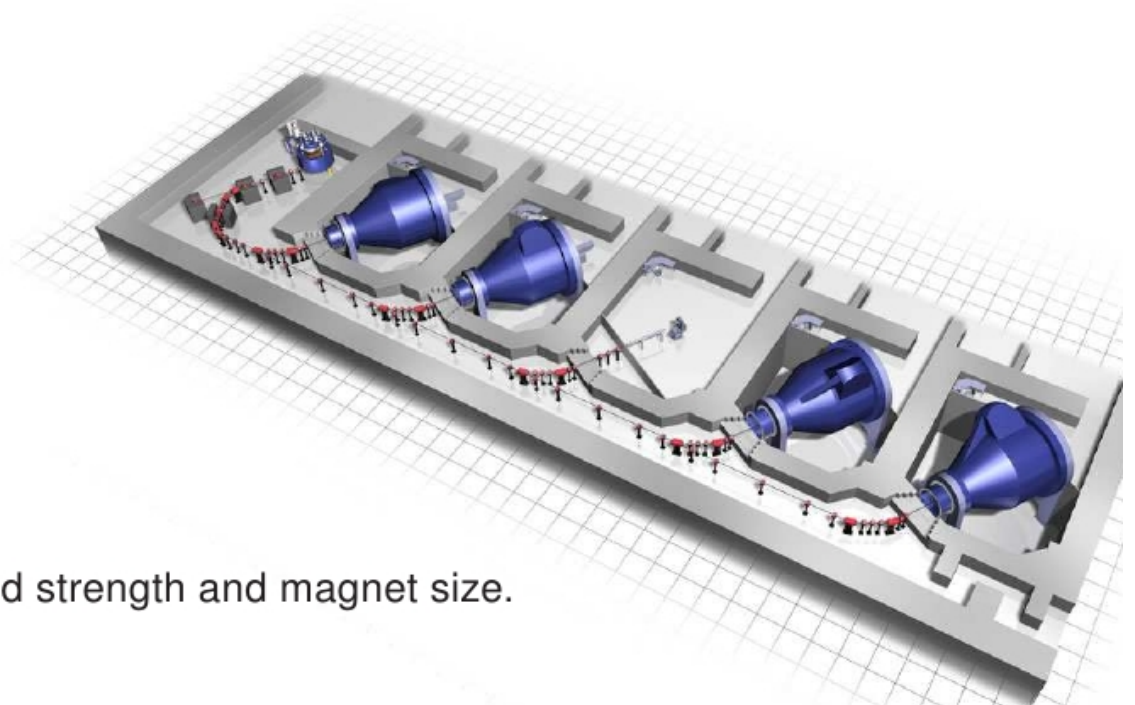
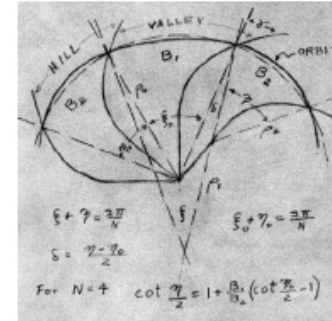
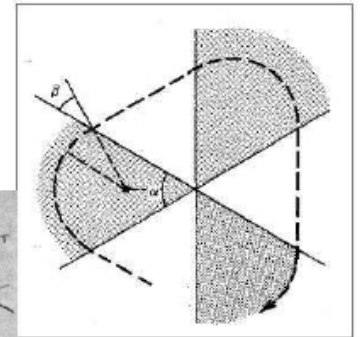

- Cyclotron is limited in energy by its field strength and magnet size.

# NOWADAYS

**Cyclotrons are everywhere in science, research, medicine.**

**Over 200.**

**In increasing number in hadrontherapy application.**

**They are an easy and “economic” way to get ion beams.**

**Some famous specimen:**

- **PSI, highest power, 1.4 MW – 590 MeV**
- **RIBs at RIKEN: highest  $K=1600$**
- **Meson factory, TRIUMF – 540 MeV**
- **Proton-therapy application – 250 MeV**
- **Radio-isotope, industrial production – a few 10s of MeV**
- **Education – small size, low energy (see Cyclo Conference/JaCOW)**



# HIGH POWER

this is where we are today,  
PSI, 590 MeV, 1.2 MW, CW

1973

- 1 Hans Willax
- 2 Miguel Olivo
- 3 Thomas Stammbach
- 4 Werner Joho
- 5 Christa Markovits



# 1966: SIN early Design – Feb. 1974:1st 100 $\mu$ A beam

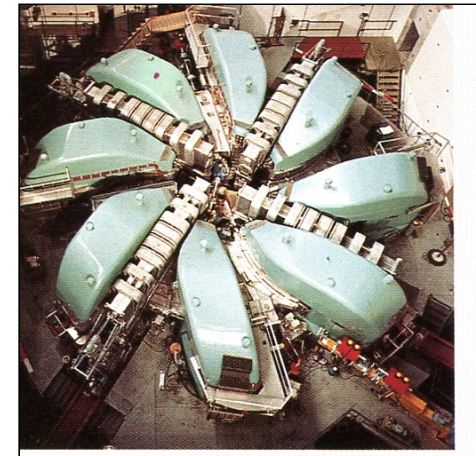
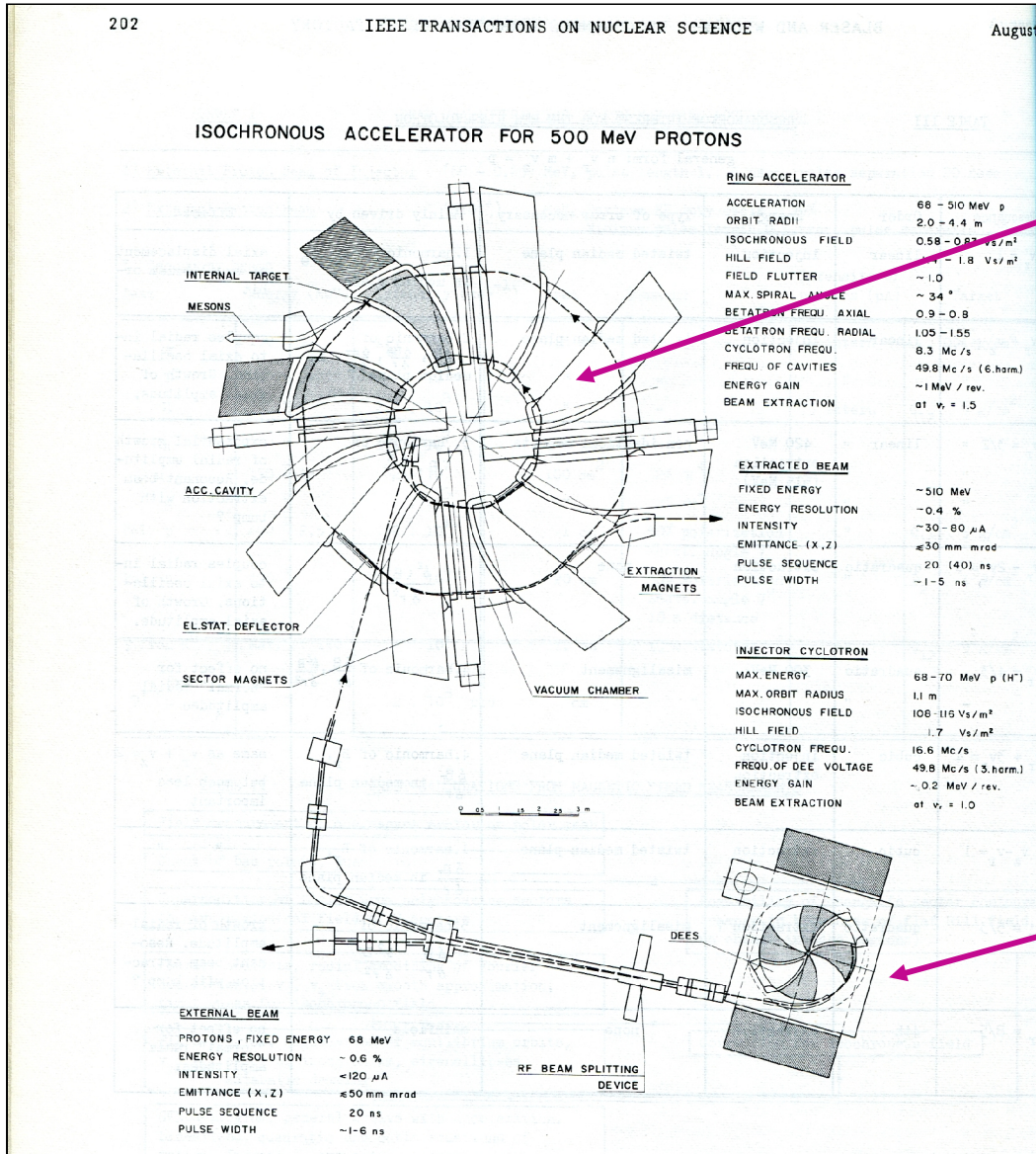

The 590 MeV Ring Cyclotron

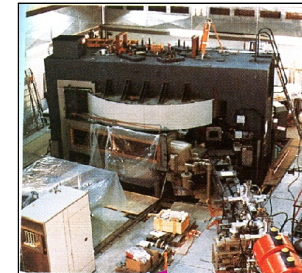

The old 72 MeV Philips injector

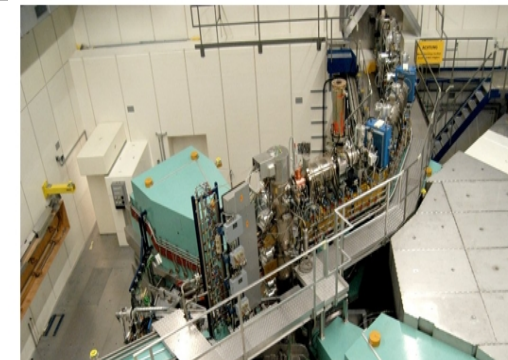

Nowadays 72 MeV injector

# Towards Higher intensities: Today 30 times more Intensity

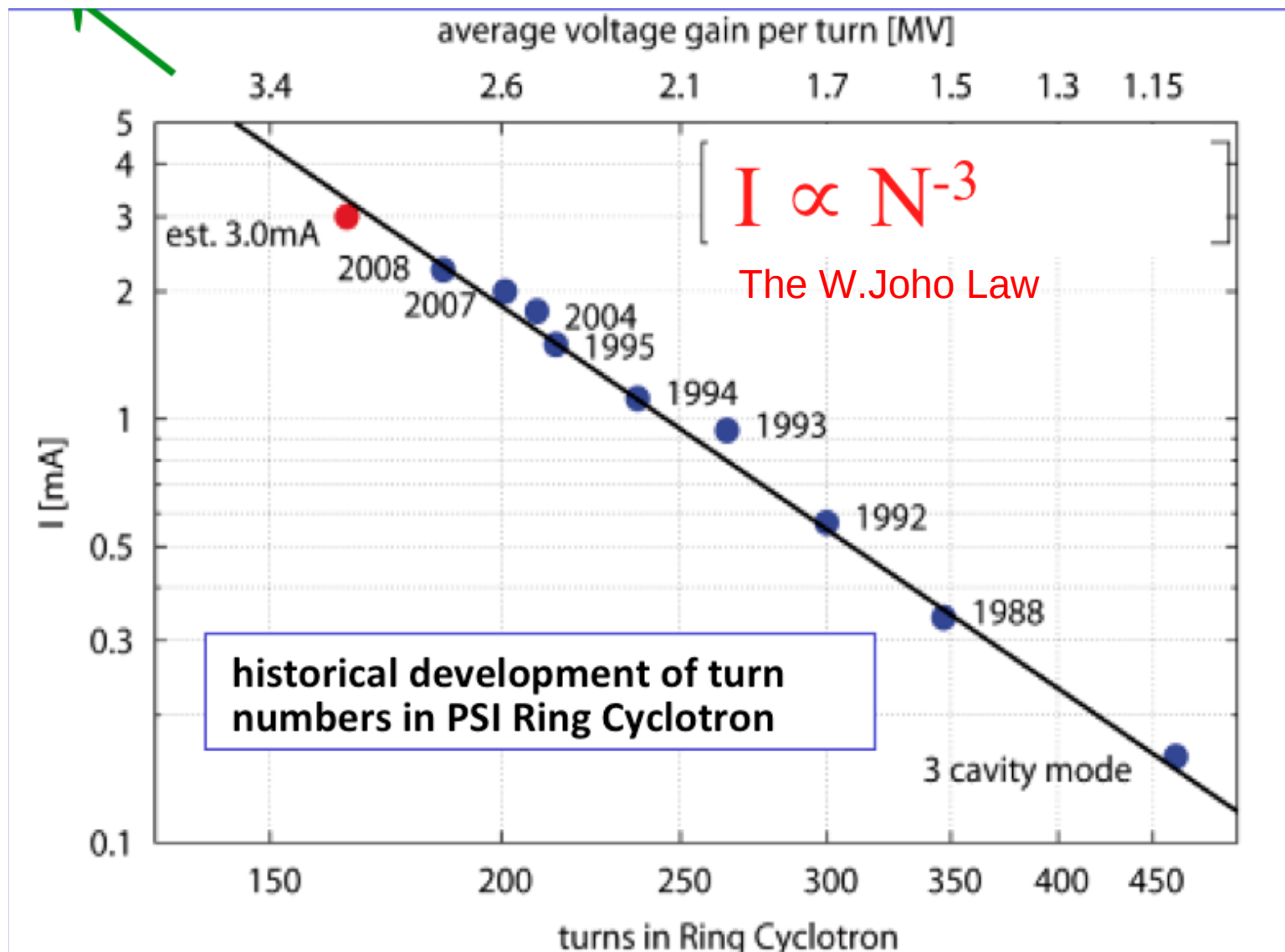

# SINQ NEUTRON SOURCE @ PSI

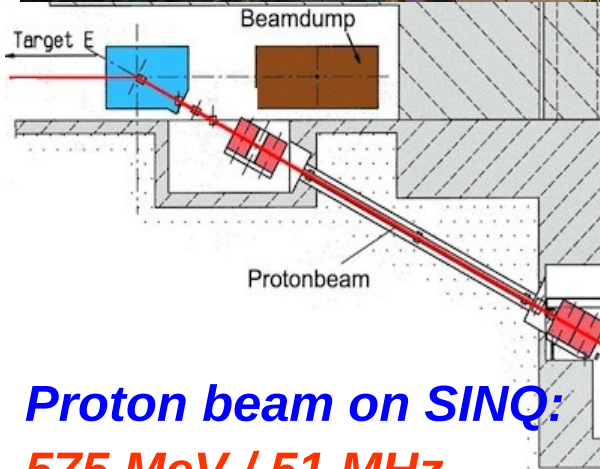
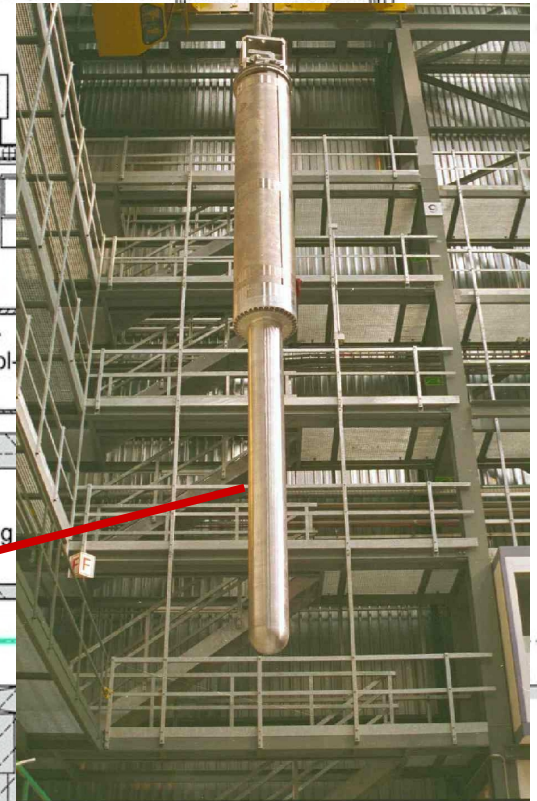
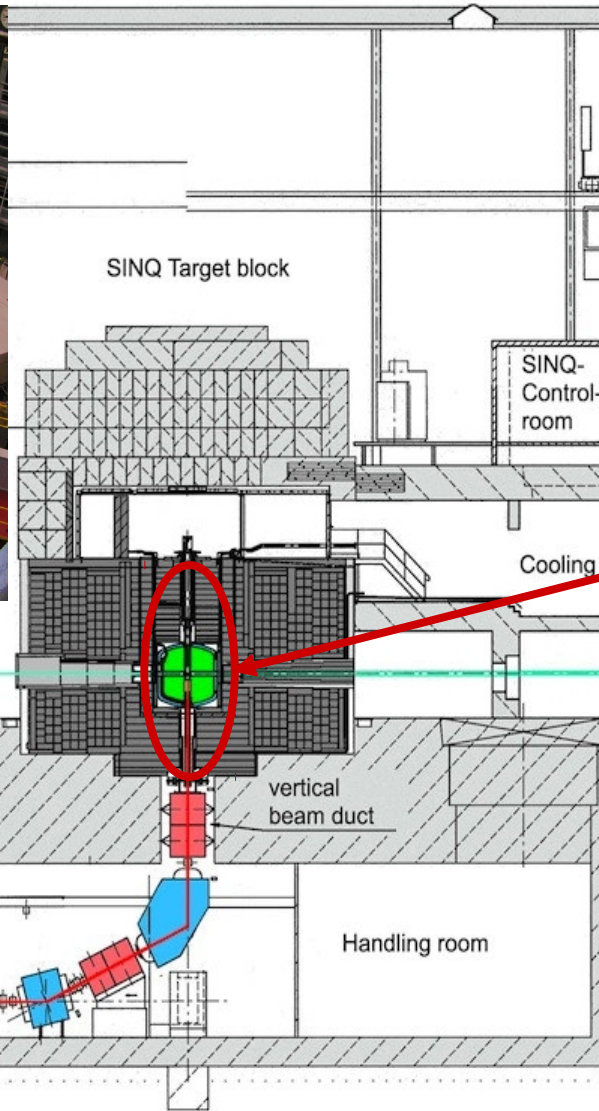

**Proton beam on SINQ:**  
**575 MeV / 51 MHz**  
**p-Current: 1.5 / 1.6 mA**  
**Power: 0.8 - 0.9 MW**

**Total Power Deposition  
in Target Assembly  
~ 575 – 610 kW**

# HIGH POWER CAPABILITIES PLACE CYCLOTRON AS STRONG COMPETITOR IN THE LANDSCAPE

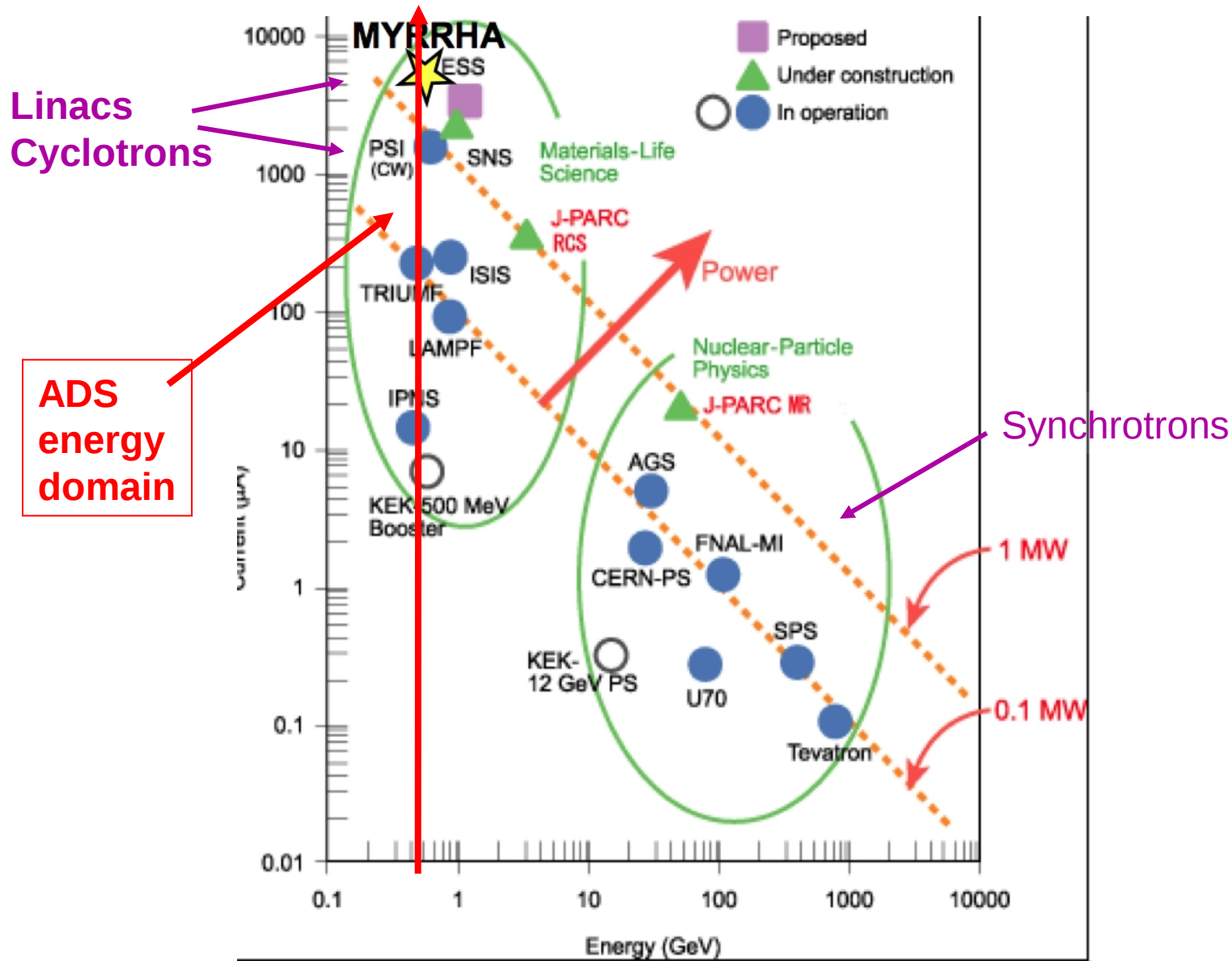



# \* ACCELERATOR-DRIVEN SUBCRITICAL REACTOR \*

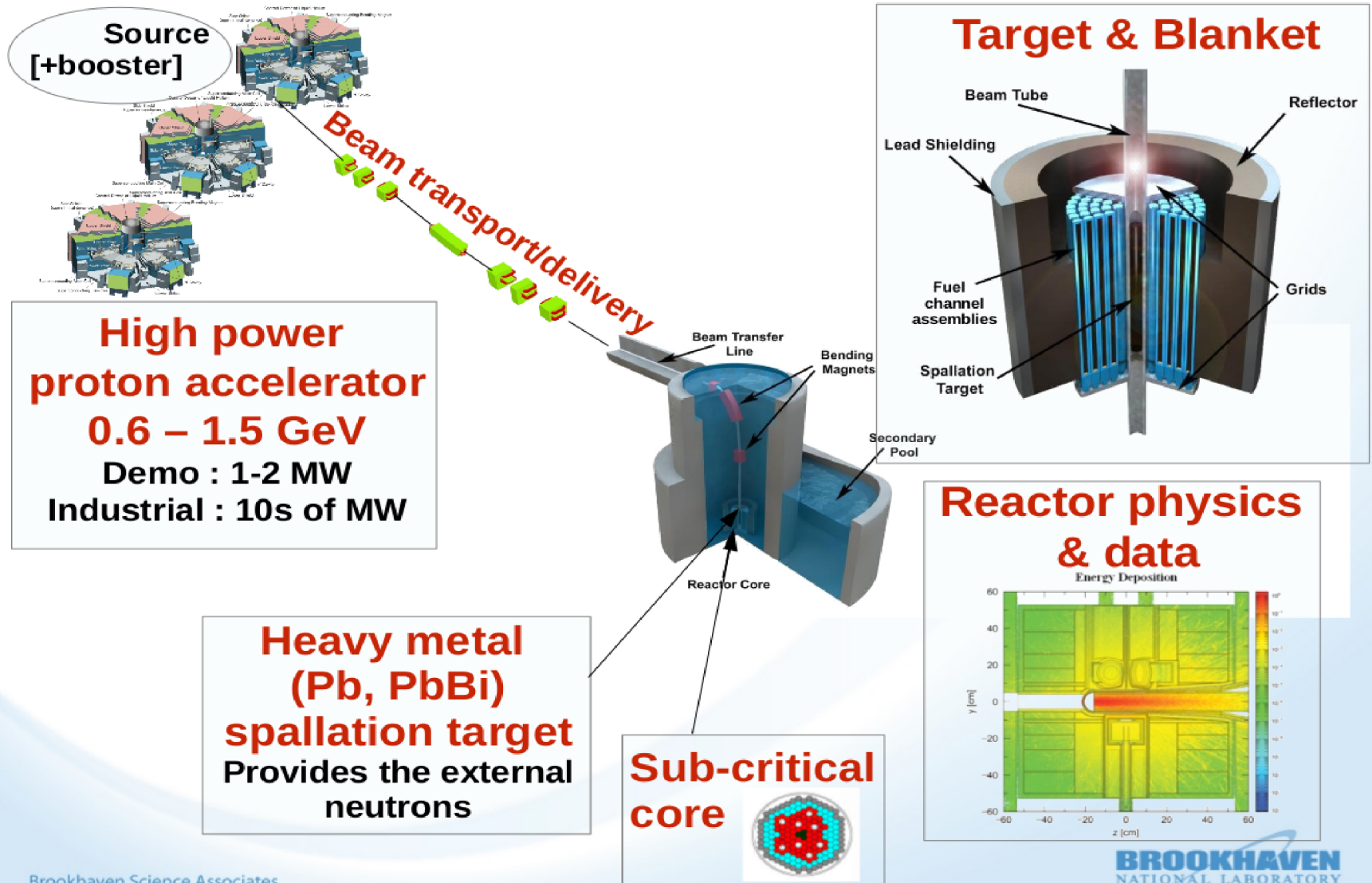

# Big discussion on-going ! which technology is optimal for ADS-R application?

Reference : US ADS White Paper (2010)

- Separate sector cyclotron

Paul Scherrer Institute,  
590 MeV, 1.3 MW CW beam  
First beam 1973



- Normal conducting proton linear accelerator

LANSCE 800 MeV n science center linac, first beam 1972.  
Ran in 1 mA / MW range in the 1980s,  
120 Hz repetition rate, DC 7.5%.

- Superconducting linear accelerator

SNS 1 GeV n science linac at ORNL,  
beam power 1.2~1.4 MW.  
Pulsed, DC ~6%. Accelerates H- for  
stripping injection into accumulator ring,  
First beam 2006

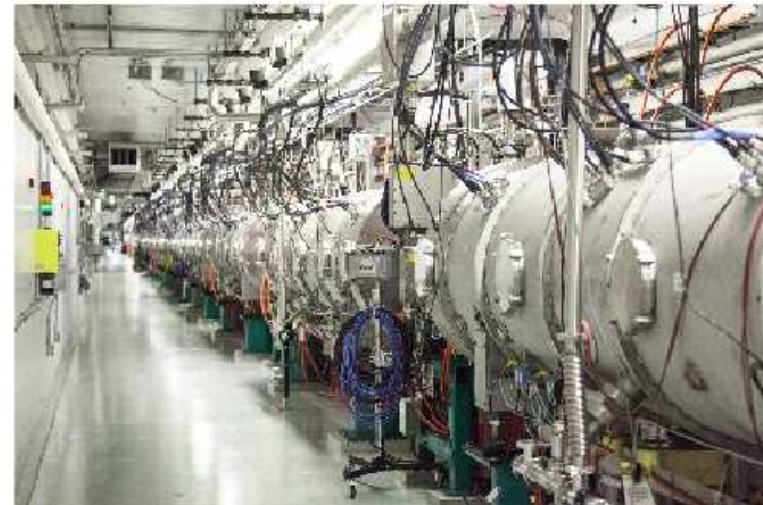

# CRYOGENY: TAKES IT TO HIGHER RIGIDITY

Riken SRC based RIBF



**Highest K cyclotron,  
8 T.m beam rigidity:  
corresponds to  
1.64 GeV proton !**

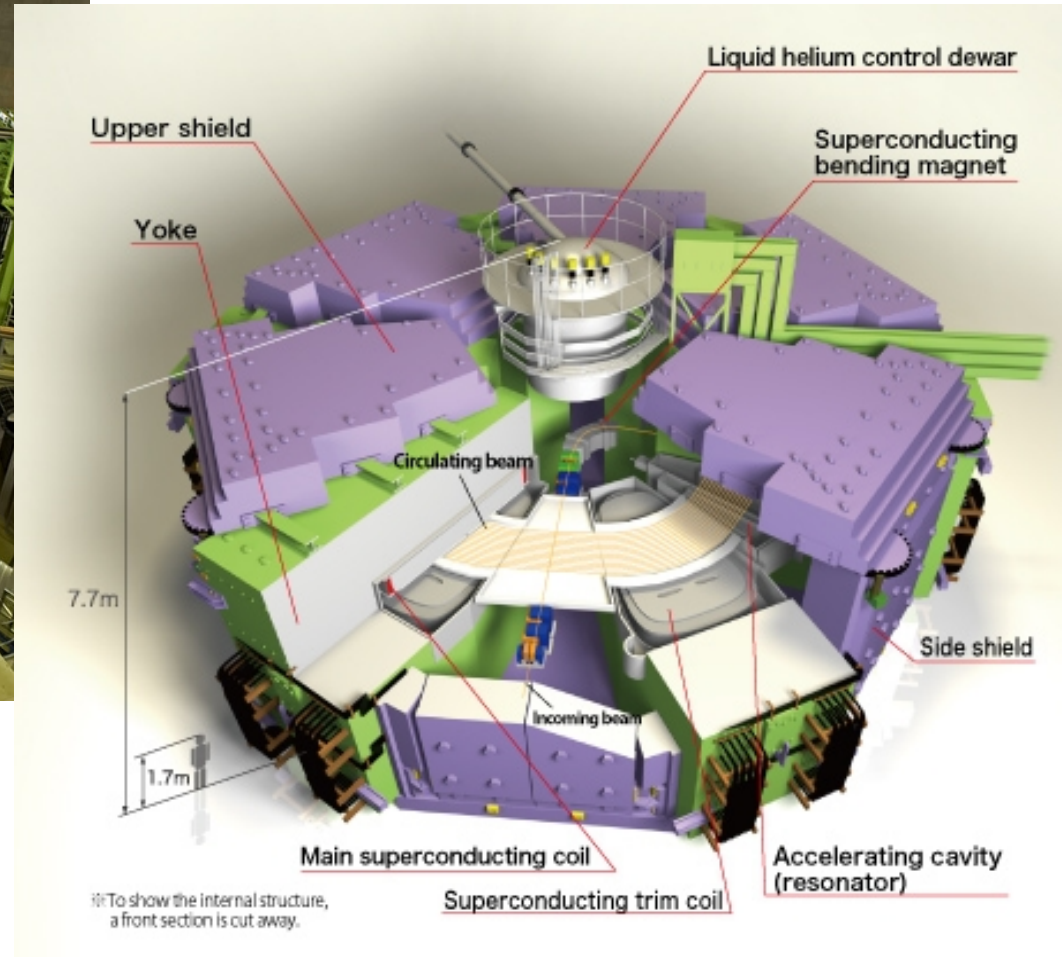

# ION BEAMS FOR HADRON-THERAPY

*AKA,*

***3-D CONFORMAL  
RADIATION-THERAPY***

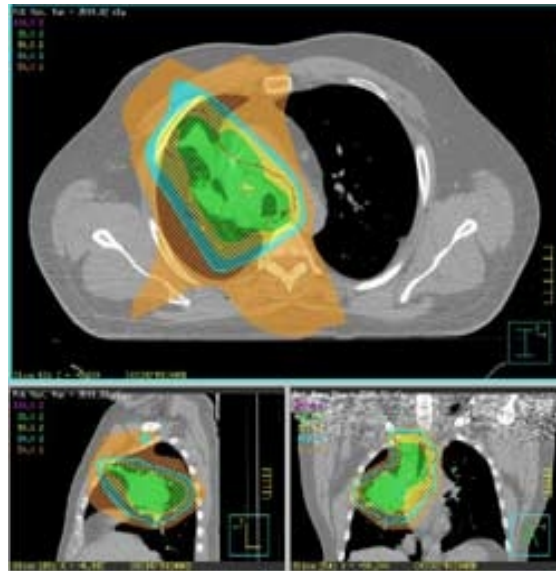

# Advantages of the bragg-peak ballistic: 3D conformal irradiation

- Better sparing of healthy tissues
- competitive with IMRT

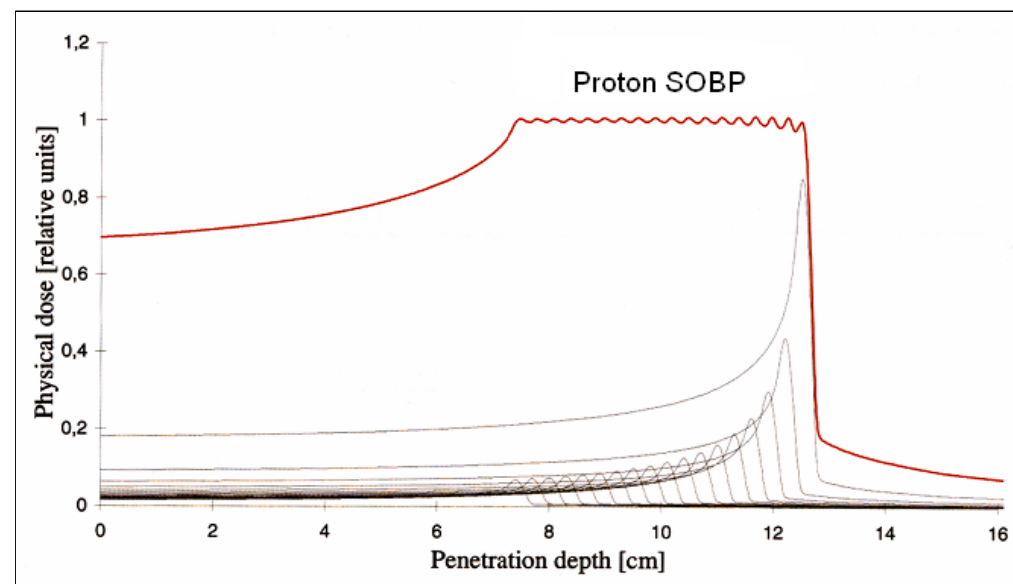
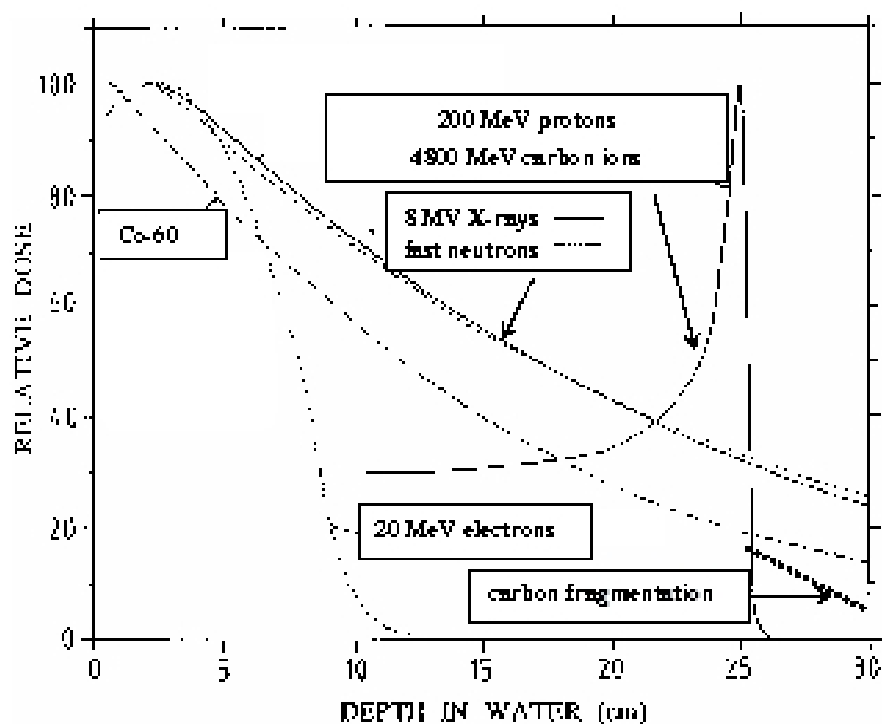
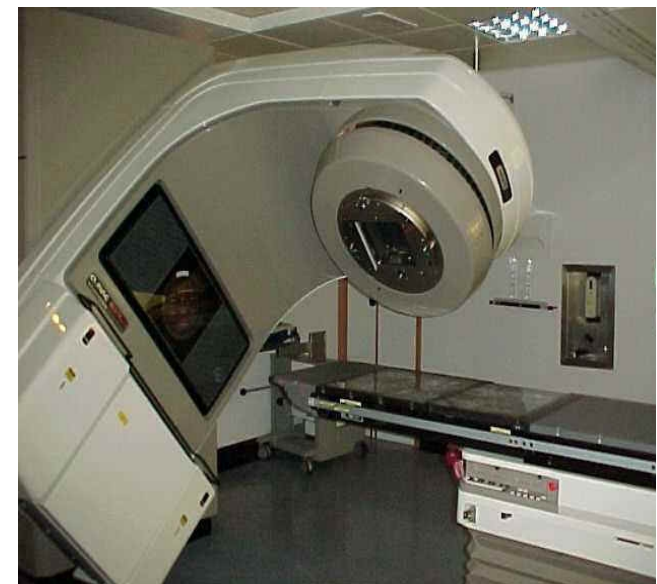
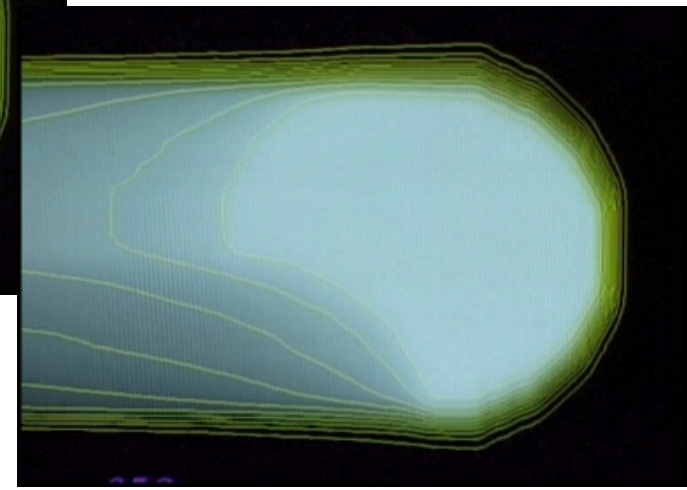
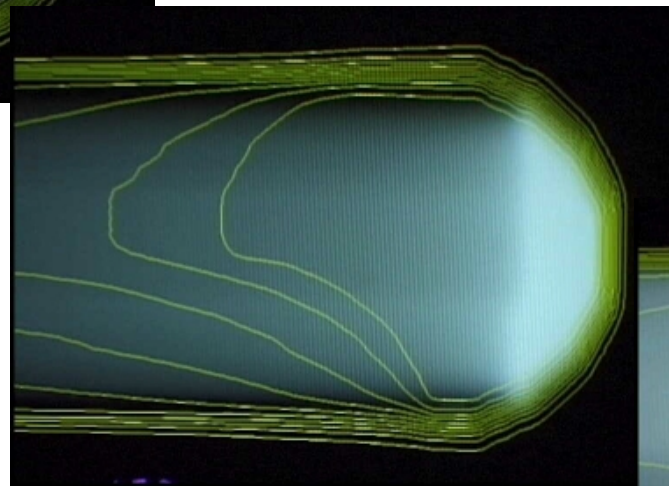
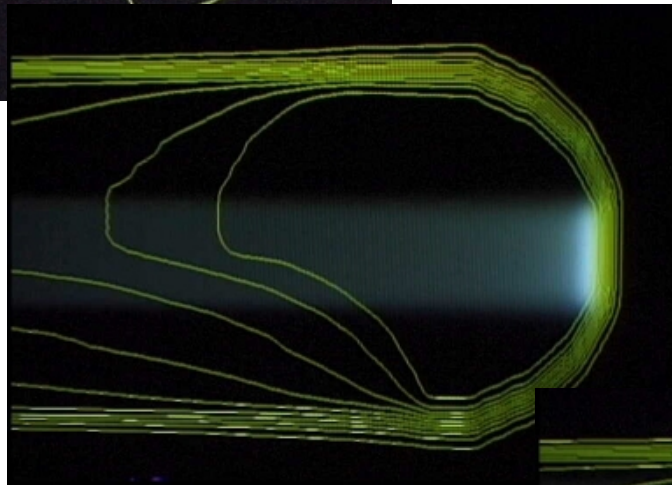
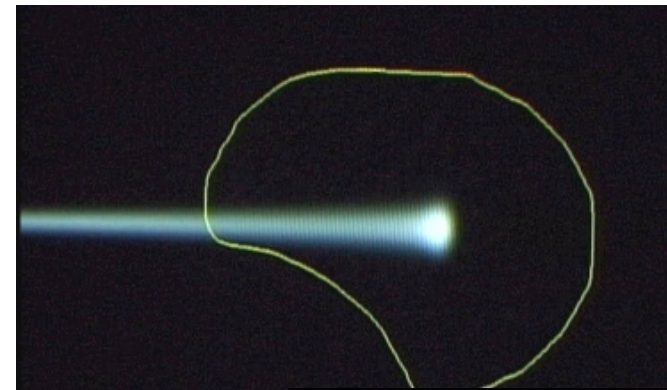
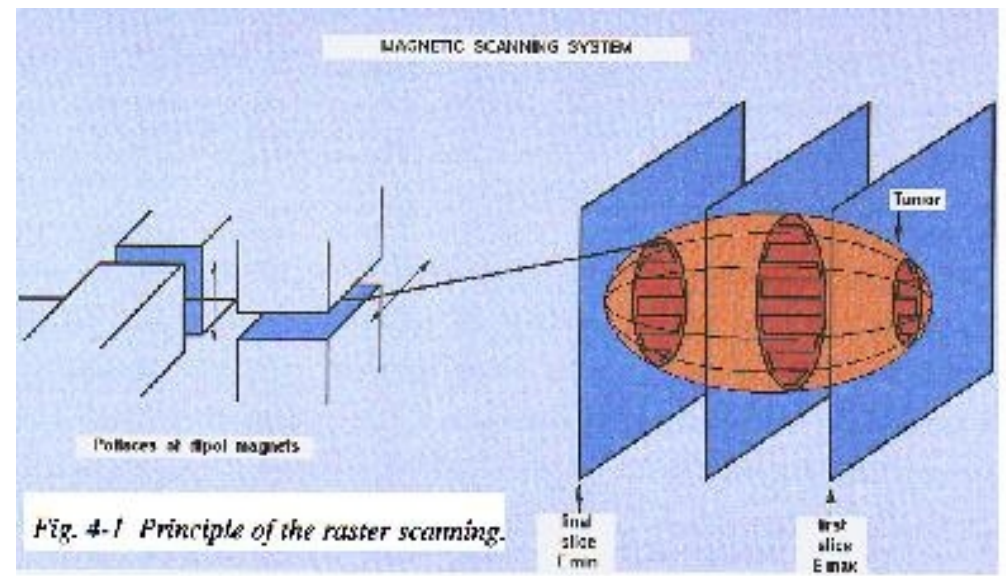

Figure 1. Depth dependence of the deposited dose for different radiations. Because of the Bragg peak it is said that the dose distribution is 'inverted' with respect to the almost exponential, and much less favourable, behaviour produced by a beam of high-energy photons.

# Active scanning



# Proton-therapy is a predilection domain in the application of the cyclotron

Yet, in passing, *and on our way to the “Synchrotron”*  
*in this ACCELERATOR course :*

- in some proton-therapy centers: a synchrotron  
instead, *weak focusing possibly* ← *Dedicated chapter*
- and in any case, **carbon-therapy, energy 70~400MeV/u,**  
**rigidity 2~6T.m:** *strong focusing, separated function*  
*synchrotron* ← *Dedicated chapter*

# On the other hand

- **An hadron (proton, carbon) accelerator is a big investment, e.g., of the order of EU150M for a turn-key carbon-therapy hospital,**
- **High cost of a session : of the order of EU600 per session, ~3x cost of an IMRT session.**

**A complete treatment requires up to 30 sessions → ~EU20k per treatment**

- **Need to find ways to scale costs down...**



# ...MEDICYC's S2C2

250 MeV protontherapy synchrocyclotron  
at Nice, France

First beam 2015

Developed with, and first  
implemented at, the  
anti-cancer  
protontherapy center  
MEDICYC, Nice.

compact gantry,  
attached to the S2C2

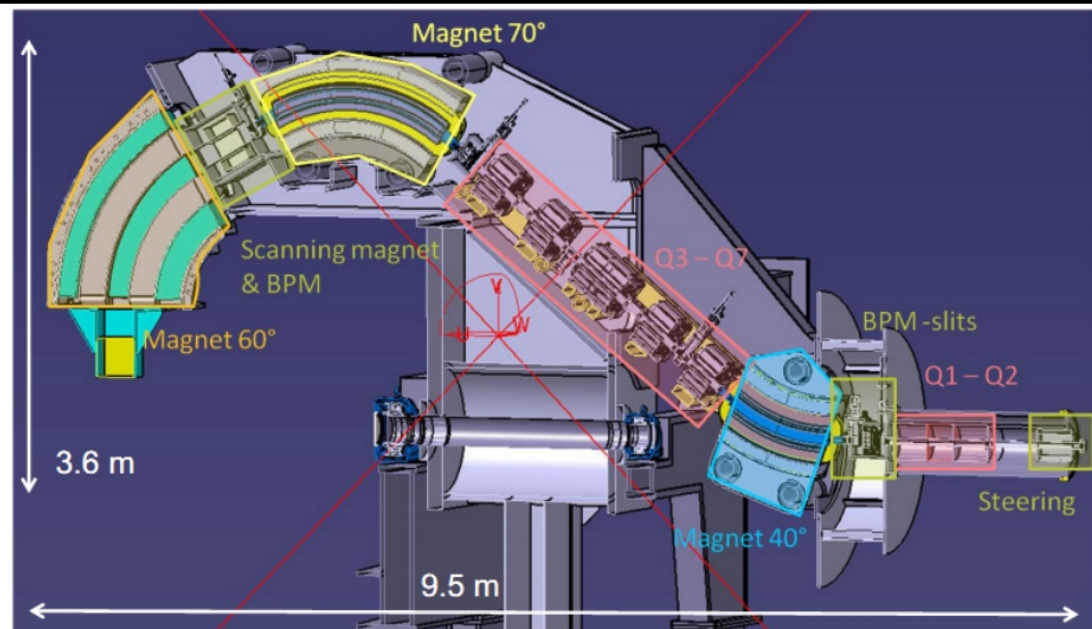

# Bibliography

- A. Sessler, E. Wilson, Engines of Discovery, World Scientific (2007)
- M.S.~Livingston, The Development of High-Energy Accelerators, Dover Pub. Inc., NY (1966).
- CERN Accelerator School archives
- JACoW <http://www.jacow.org/>
- Joint Universities Accelerator School lectures  
<http://www.esi-archamps.eu/Thematic-Schools/Discover-JUAS>
- USPAS archives
- National Lab sites, US, EU
- CERN documentation web sites
- BNL's Flickr photo gallery
- Wikipedia
- G.~Leleux, Circular accelerators, INSTN lectures, SATURNE Laboratory, CEA Saclay (Juin 1978).