

PHY 554

Fundamentals of Accelerator Physics

Mon, Wed 5:30-6:50PM Soc. Behavior N115

As needed: in person Office Open Hour, Physics, D102



Vladimir
Litvinenko



Yichao
Jing



Gang
Wang



Kai
Shih



Jun
Ma



Navid
Vafaei-Najafabadi

Vladimir N. Litvinenko, Yichao Jing, Jun Ma, Gang Wang and Kai Shih
Class on Plasma Accelerators will be taught by Navid Vafaei-Najafabadi

http://case.physics.stonybrook.edu/index.php/PHY554_Fall_2023

Center for Accelerator Science and Education
Department of Physics & Astronomy, Stony Brook University
Collider-Accelerator Department, Brookhaven National Laboratory

Logistics I: the course

The course focuses on the fundamental physics and key concepts of modern particle accelerators.

The course is intended for graduate students and advanced undergraduate students:
Goal is to familiarize yourselves with principles of accelerating charged particles and to gain knowledge about particle accelerators and their applications.

It will cover the following :

- a) History of accelerators and basic principles
- b) Radio frequency cavities, normal and Super-Conducting linear accelerators
- c) Magnets, transverse motion, strong focusing, non-linearities and resonances
- d) Circulating beams, longitudinal dynamics, synchrotron radiation, beam cooling
- e) Applications of accelerators and advanced concepts

Mon, Wed 5:30-6:50PM SOCBEHAV SCI N115

Logistics II: Goals

- a) To understand how various types of accelerators work and difference between them
- b) To understand transverse and longitudinal beam dynamics in accelerators
- c) To have a general understanding of accelerating structures
- d) To learn about major applications of accelerators
- e) To learn standard accelerator physics lingo such as betatron and synchrotron tunes, β -and η/D -functions, chromaticity, resonances, instabilities..... list going on and on
- f) To learn what are so-called advanced accelerator concepts

Your final grade will be based on the following:

class participation - 20%;

home-works – 40%;

final presentation of a research paper / project – 40%.

Logistics III: materials

- a) Recommended text books:
 - An Introduction to the Physics of High Energy Accelerators, by D. A. Edwards and M. J. Syphers
 - Introduction To The Physics Of Particle Accelerators, by M. Conte and W.W. Mackay
- b) Nevertheless, all material will be provided in lecture notes, and it is your choice to buy a book or two
- c) PDF copy of our lectures will be on the course website, typically before class starts;
- d) We will give you HW problems (exception is today's class), which you can solve yourself or in collaboration with your class-mates (which will be appropriate to acknowledge);
- e) You have to return HWs within one week (the same class week later or by email) – in the case of the holidays coinciding with our class: return it two classes after the HW was handled to you
- e) We will give you a list of accelerator projects, but you also can suggest us your own project if it is related to accelerators. *Important: Students supported by ECT US Department of Energy grant should choose research topic related to one of DOE areas of interest: Physics of large accelerators and systems engineering; Superconducting radiofrequency accelerator physics and engineering; Radiofrequency power system engineering and Cryogenic systems engineering (especially liquid helium systems).* We will help you with locating appropriate reading materials and papers.

Syllabus

1. Visiting BNL accelerators

2. Introduction to accelerator physics - You will have a glance into the history of accelerators and will learn about a variety of accelerators from electrostatic TV-tubes to gigantic atom and nuclear smashers. Basic figures of merit will be introduced (center of mass energy, luminosity, accelerating gradient, etc.) You will learn general principles behind linear accelerators and circular accelerators, their relative advantages and disadvantages.

2. Radio frequency cavities, linacs, superconducting RF accelerators - This part of the course will be dedicated to physics and technology of accelerating structures. You will learn basic principles of using radio frequency electromagnetic fields to accelerate particles to very high energies. Different types of accelerating structures will be introduced. You will also learn about brand new direction in linear accelerators – so-called energy recovery linacs. As many modern accelerators are based on superconducting RF (SRF) technology, you will learn fundamentals of the SRF accelerators and their advantages over conventional (normal conducting) RF accelerators.

3. Linear transverse beam dynamics - This part of the course will be dedicated to detailed description of linear dynamics of particles in accelerators. You will learn about similarity of particles motion to an oscillator with time-dependent rigidity, matrix optics of various elements in accelerators, equation for beam envelopes and stability of periodic (circular) motion of the particles. Here you find a number of analogies with planetary motion, including oscillation of Earth's moon. You will learn some “standards” of the accelerator physics – betatron tunes and beta-function and their importance in circular accelerators.

4. Nonlinear transverse beam dynamics - This lecture will open door in fascinating and never-ending elegance and complexity on nonlinear beam dynamics. You will learn about non-linear resonances, which may affect stability of the particles and about their location on the tune diagram. You will learn about chromatic (energy dependent) effects, use of non-linear elements to compensate them, and about problems created by introducing them. Some of traditional perturbation theory methods will be introduced during this lecture.

5. Longitudinal beam dynamics - If you were ever wondering why Saturn rings do not collapse into one large ball of rock under gravitational attraction – this where you will learn of the negative mass effect in longitudinal motion of particles. You will also learn about so-called synchrotron oscillations, which are have a lot of similarity with a pendulum motion. One more “tunes” to remember about - synchrotron tune.

6. Radiation effects - Charged particles going around an accelerator do radiate when their trajectory is bent – hence, there is entire range of topics arising from this fact. It goes from such effect as radiation damping of the particle oscillations, quantum excitation of such oscillation to the use of this extraordinary radiation as cutting-edge research tool. We will look both into positive (usefulness of synchrotron and FEL radiation) and negative (limiting the energy of electron storage rings) aspects of this natural phenomenon.

7. Plasma accelerators – This new and rapidly expanding area of accelerator science promises major – orders of magnitude – increase in accelerating gradient, which could result in both miniaturizing accelerators as well as in reaching new energy frontiers in colliders.

8. Accelerator application - We will devote this part of the course to the discussion of variety of accelerator application, among which are accelerators for nuclear and particle physics, X-ray light sources, accelerators for medical uses, etc. You will also learn about future accelerators at the energy and intensity frontiers as well as about new methods of particle acceleration.

We have some questions to understand what is your math and physics background?

Knowing it will help us shaping our classes to have maximum impact and, when necessary, add a background material

- Calculus
 - Differential equations: ordinary, partial?
 - Integrals – 1D? Multi-dimensional?
 - Vector analysis – 3D?
 - Matrix analysis? Tensors?
 - Complex analysis? theory of functions of a complex variable?
- Physics
 - Classical mechanics: harmonic oscillator?
 - E&M: Maxwell equations? Lorentz force? EM waves?
 - Special relativity? Energy & momentum? Lorentz transformations? 4-vectors?
 - Hamiltonian mechanics: Lagrangian & Hamiltonian equations
- Important note : If and when necessary, we will introduce the background information needed for the classes

Questions?

Lecture 1

Modern Accelerators

Accelerators evolve from a tiny devices to structures easily observed from the space

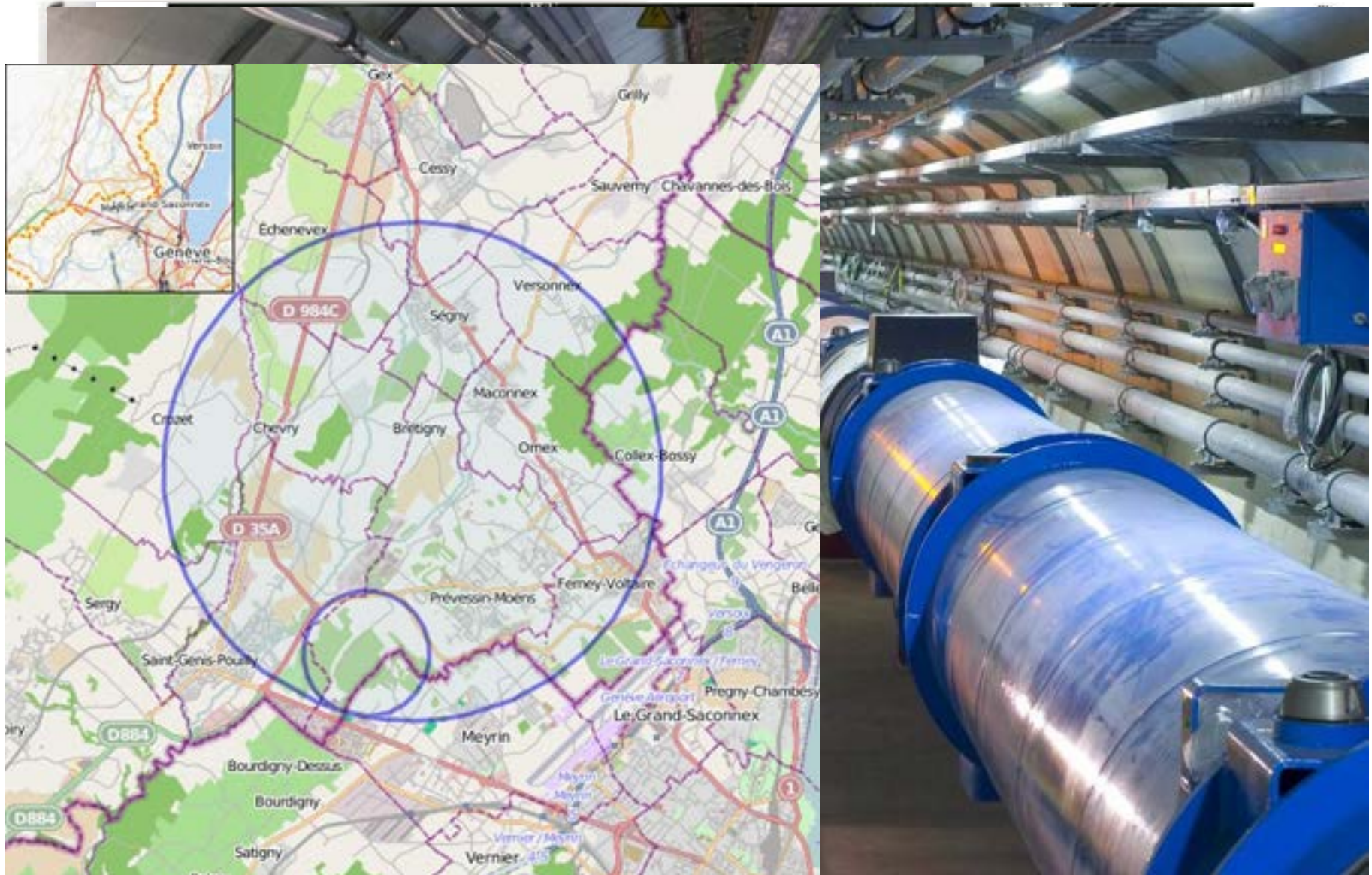

What Accelerators Are Good For

- High Energy Physics & Nuclear Physics
 - Explore the electro-weak bosons Z , W
 - Find and exploit “new“ and heavy quarks
 - Higgs physics and physics beyond standard model
 - Create new states of matter such as quark gluon plasma or colour-glass condensate
 - In short: search for answers of the most fundamental questions
- Chemistry, Biology, Medicine, Material Sciences
 - Find the structure of molecules, proteins, cells... with ultimate goal of determining structure of a single organic molecule as complex as a protein!
 - Determine structure of material and create new materials
 - To answer if people could survive interstellar travel?
 - Resolved structural changes at a natural - femtosecond and attosecond - time scales
- Civil, Industrial and Military Applications
 - Treat cancers, produce isotopes for medical imaging, sterilize products... implant ions into the semiconductor chips...
 - Scan containers in ports for undesirable content (n's?)
 - High power free electron lasers as weapons for a ship defence or for producing new generation of chips for your computers
- Well, this list will never be complete

Accelerator allowed us to discover the entire Zoo of elementary particles and their combinations (states)

Standard Model of Elementary Particles

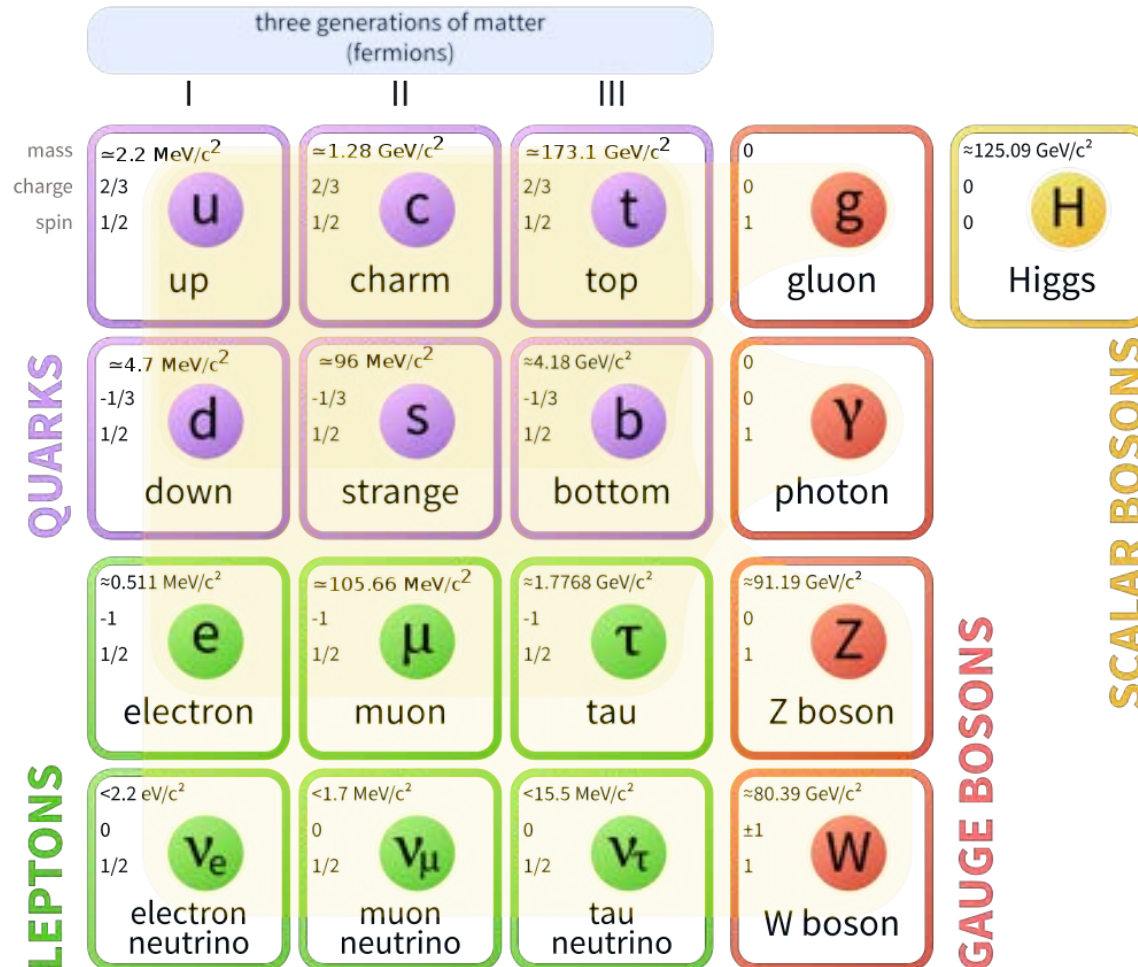

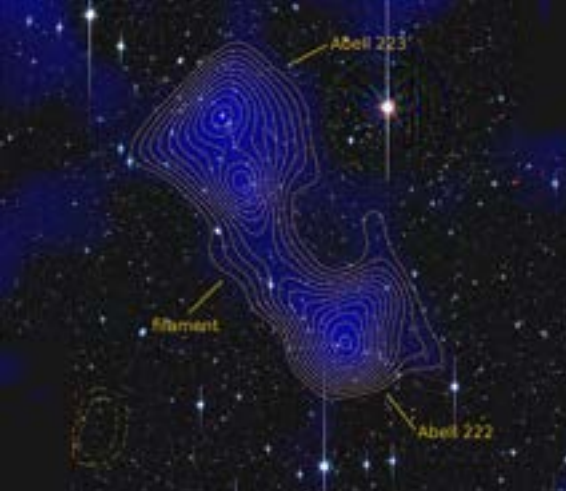
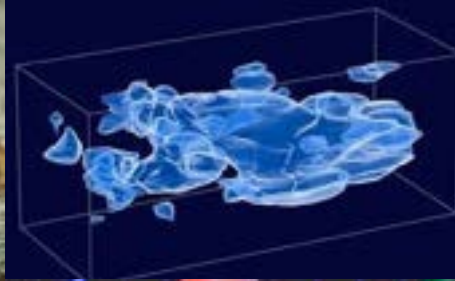

**FAR
BEYOND**

What Do We Accelerate?

- We use electric field to accelerate particles
 - hence, particles must be charged to be accelerated!
- Most common of accelerators use electrons, protons, or ions
- Few accelerators use positrons or antiprotons
 - which are created by smashing accelerated electron or protons into a target
- Usually we accelerate stable particles
 - again electrons, protons, their antiparticles and stable ions
- A few dedicated facilities accelerate unstable ions
 - radioactive ion facilities (FRIB at MSU)
- Finally, there is a discussion and developments towards a more exotic collider using unstable muon beams
 - with 2 microsecond lifetime in the rest frame

Few numbers and units

Particle	Charge	Charge, C	Rest mass, kg	Rest mass, eV/c ²
Electron, e ⁻	-e	$-1.602 \cdot 10^{-19}$	$9.11 \cdot 10^{-31}$	$0.511 \cdot 10^6$
Positron, e ⁺	+e	$+1.602 \cdot 10^{-19}$	$9.11 \cdot 10^{-31}$	$0.511 \cdot 10^6$
Proton, p	+e	$+1.602 \cdot 10^{-19}$	$1.6726 \cdot 10^{-27}$	$938.27 \cdot 10^6$
Antiproton	-e	$-1.602 \cdot 10^{-19}$	$1.6726 \cdot 10^{-27}$	$938.27 \cdot 10^6$
Ion, Z_A	Ze		$\sim A \cdot u$	$\sim A \cdot u$
Atomic mass unit, u			$1.6605 \cdot 10^{-27}$	$931.49 \cdot 10^6$

Speed of the light, c

$2.99792 \cdot 10^8$ m/sec

$$1eV = 1.602 \cdot 10^{-19} J$$

1 eV – energy gained by an electron passing through a 1 V potential differential

Thermionic electron source

❖ Heated metals

- Some electrons have energies above potential barrier

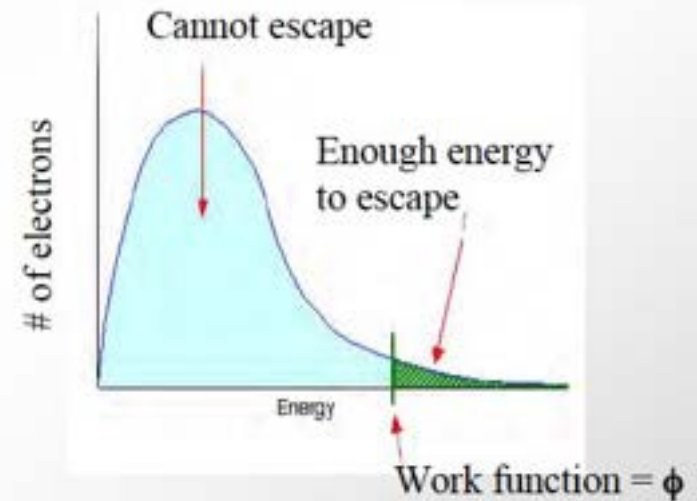
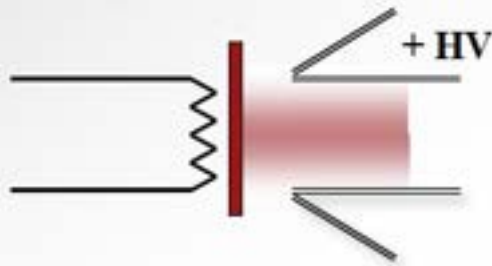

Electrons in a metal obey Fermi statistics

$$\frac{dn(E)}{dE} = A\sqrt{E} \frac{1}{\left[e^{(E-E_F)/kT} + 1 \right]}$$

Courtesy of W. Barletta

Photo-emission electron source

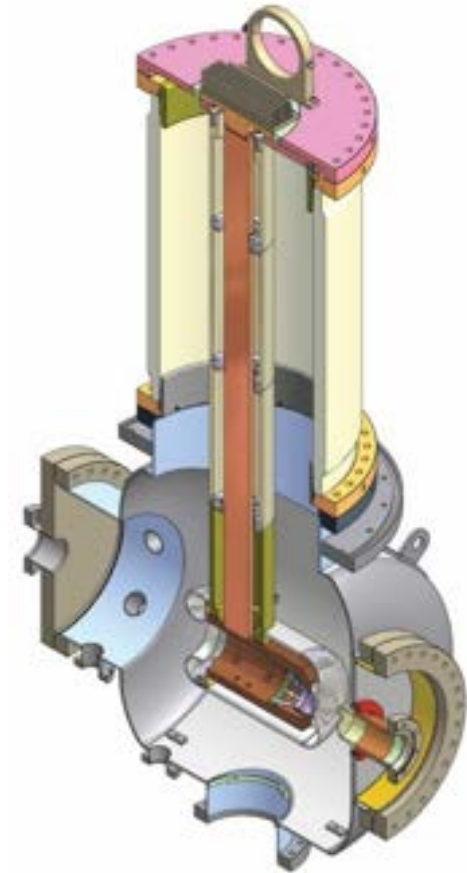
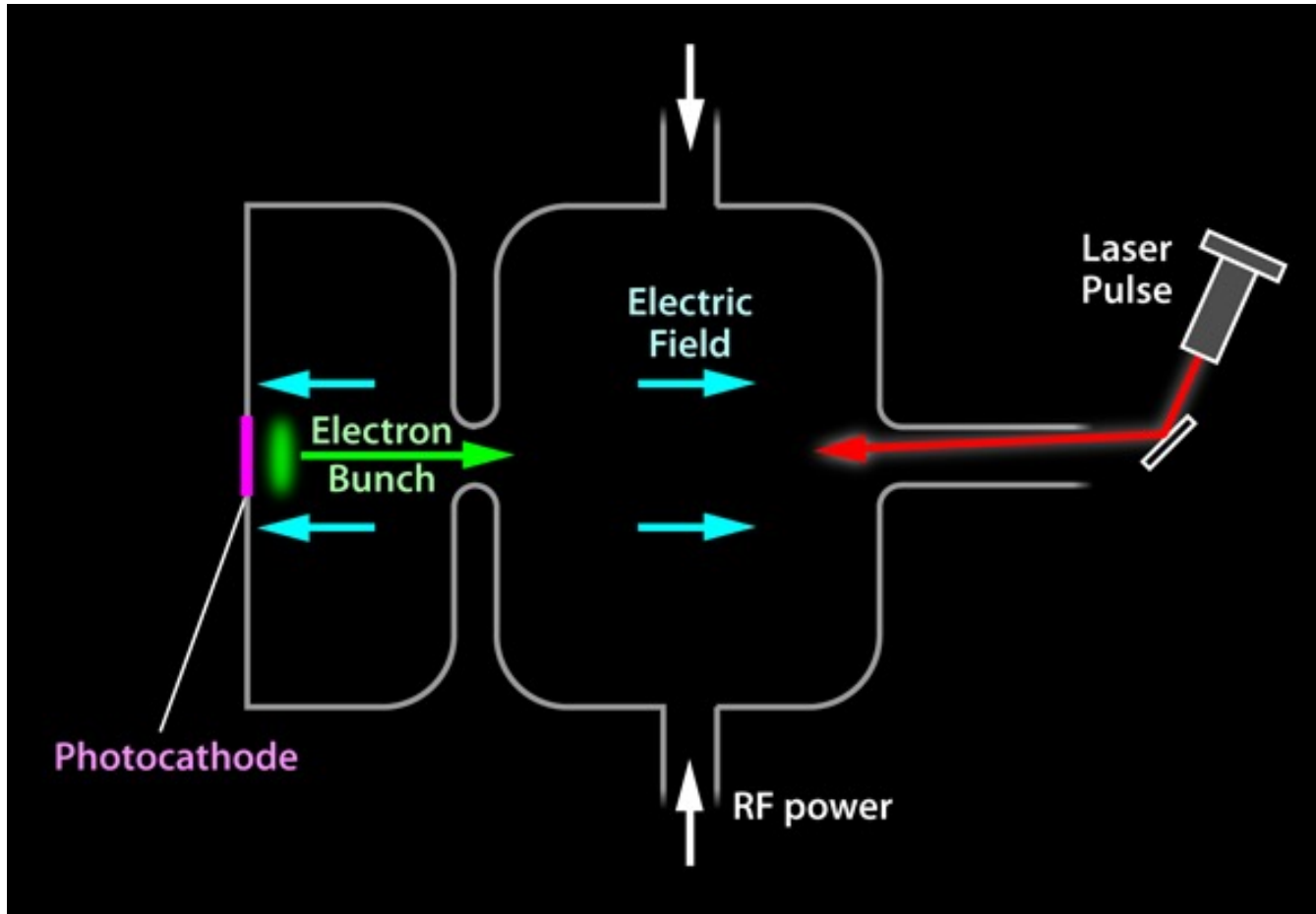

Typical ion source

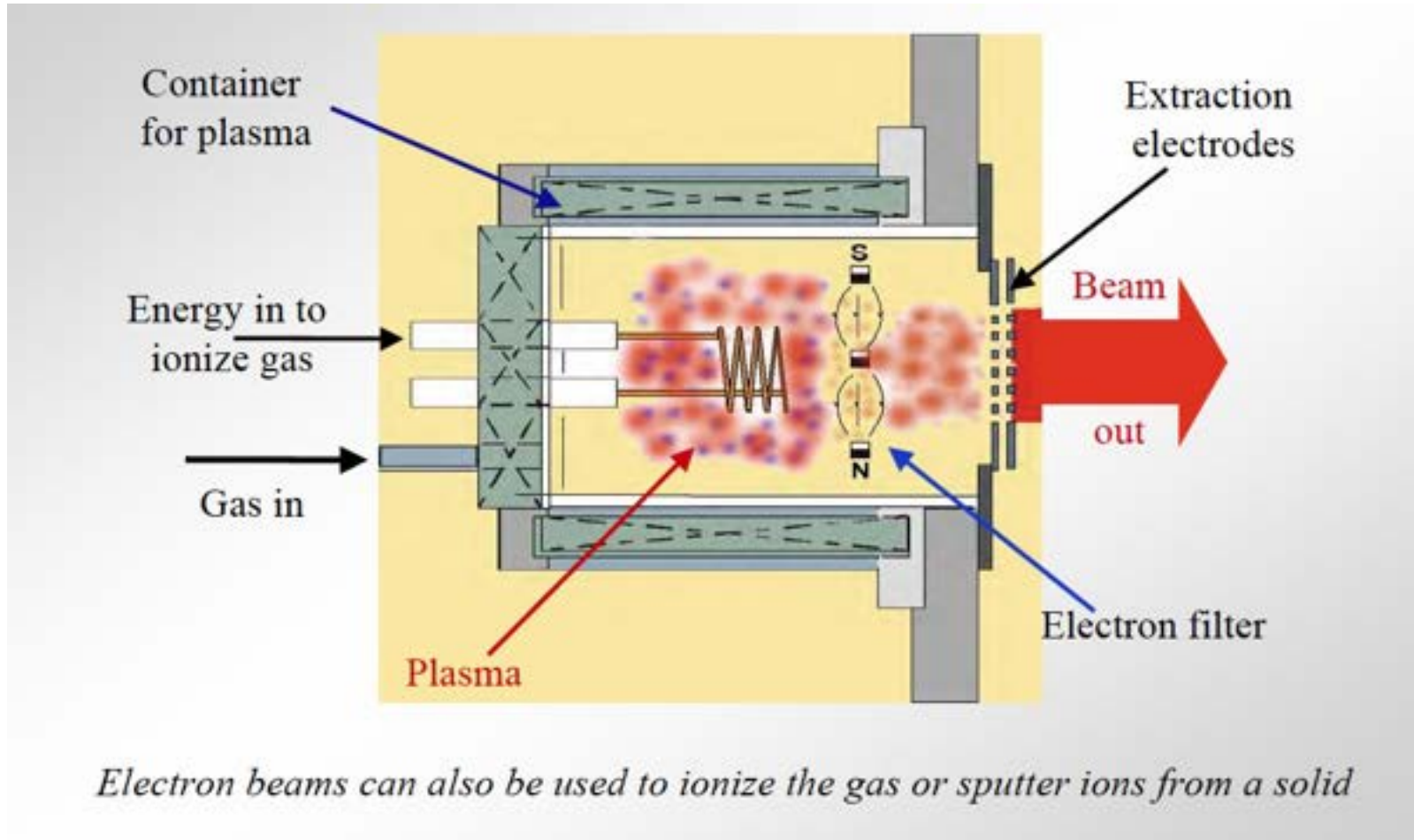

Courtesy of W. Barletta

Novel methods: example, ATF at BNL

$$E_{\max} (\text{MeV}) \sim I$$

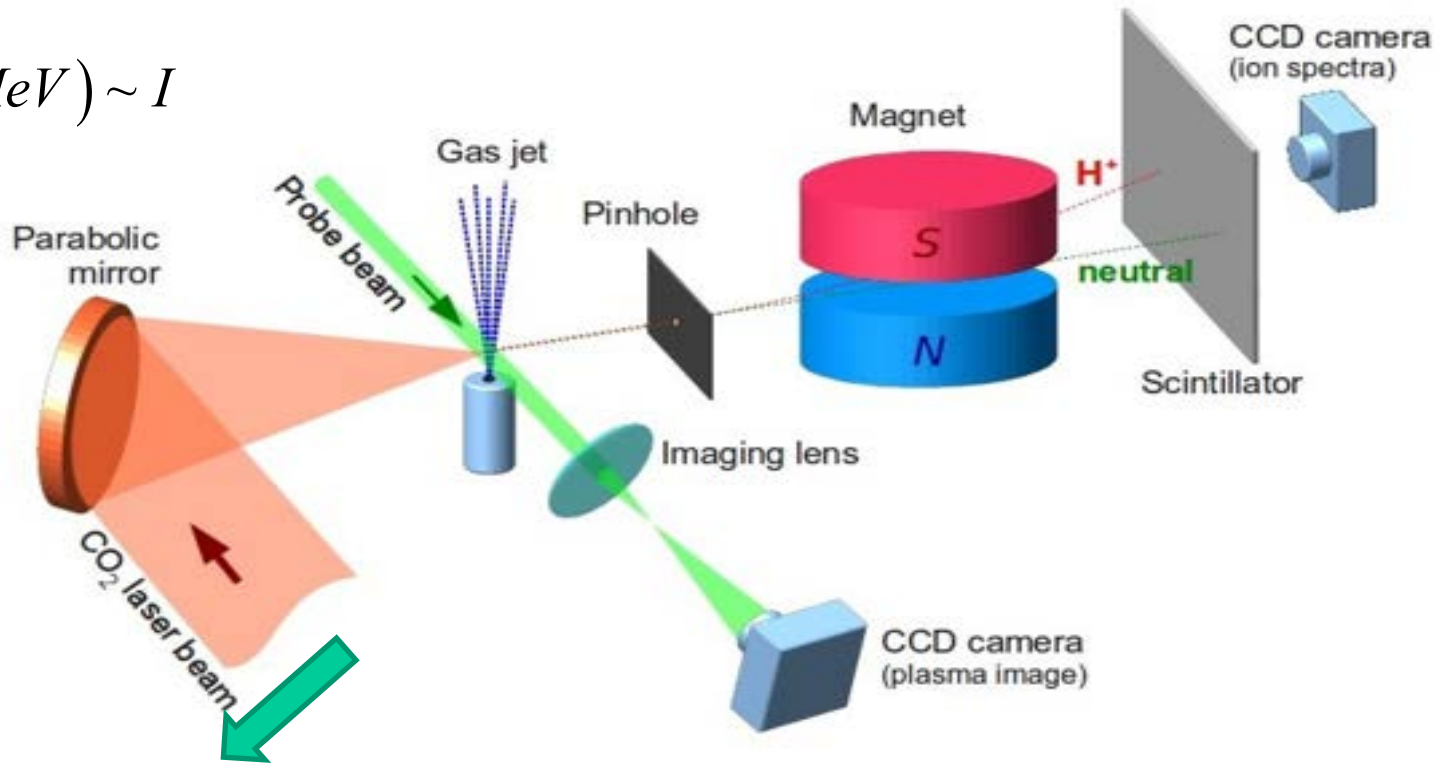

A monoenergetic proton beam is observed from the interaction of a short-pulse infrared laser with a gas jet target. Electrons are pushed out of the gas jet (or metal foil) by high laser pulse, then pull out ions and accelerate them.

Positron/Antiproton sources are very complex and expensive

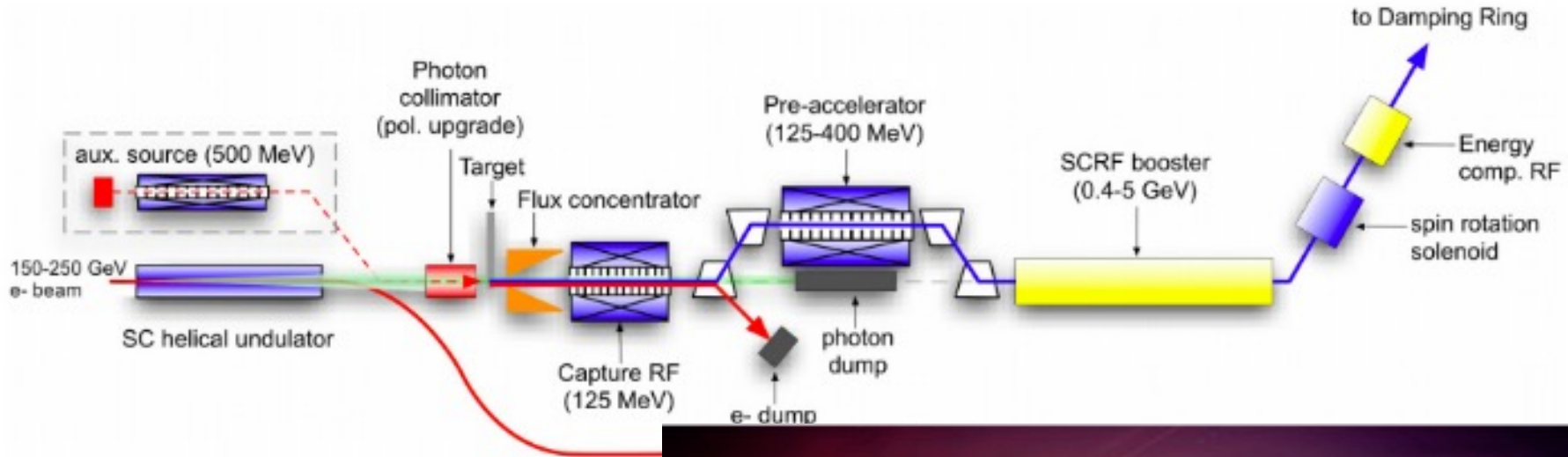

Welcome to the Relativistic World

- With rare exception particles in accelerators traveling with speed approaching the speed of light
- Speed of particles is not a good figure of merit for an accelerator – instead, we are using the particle's energy, frequently expressed in eV, keV, MeV, GeV and TeV
- Hence, let's just remind ourselves the basics of the special relativity

Special Relativity

- Space and time coordinates transform according to the Lorentz transformation

$$x = \frac{x' + \frac{v}{c}(ct')}{\sqrt{1 - \frac{v^2}{c^2}}}; \quad ct = \frac{ct' + \frac{v}{c}x'}{\sqrt{1 - \frac{v^2}{c^2}}}; \quad y = y'; \quad z = z'; \quad x^\mu = (ct, x, y, z)$$

- The interval is preserved under Lorentz transformation (e.g. it is invariant)

$$s = \left(c(t_1 - t_2) \right)^2 - \left(\vec{r}_1 - \vec{r}_2 \right)^2 = \text{inv}$$

Special Relativity

- Relativistic energy and momentum of a moving particle is given by

$$E = \gamma mc^2; \vec{p} = \gamma m\vec{v}; \quad \gamma = \frac{1}{\sqrt{1 - \vec{v}^2/c^2}}; \quad p^\mu = (E/c, \vec{p})$$

- Difference between the squares of the energy and the momentum squared multiplied by c^2 is invariant of the motion and is defined by the rest mass of the particle

$$(p^0)^2 - \vec{p}^2 = inv \Leftrightarrow E^2 - \vec{p}^2 c^2 = m^2 c^4$$

How fast are our particles

- It is a common place to say that in modern accelerators particles move nearly the speed of light. It is true that

$$\gamma \gg 1; v = c \sqrt{1 - \frac{1}{2\gamma^2}} \cong c \left(1 - \frac{1}{2\gamma^2} \right)$$

- And $\gamma \propto 10^2 - 10^4$ for a typical light source or a typical collider
- Hence, the question is how many 9's one want to keep

	Electrons		Protons	
	K Energy, eV	v/c	K Energy, eV	v/c
1 eV	1.00E+00	0.0020	1.00E+00	0.00005
10 eV	1.00E+01	0.0063	1.00E+01	0.00015
100 eV	1.00E+02	0.0198	1.00E+02	0.00046
1 keV	1.00E+03	0.0625	1.00E+03	0.00146
10 KeV	1.00E+04	0.1950	1.00E+04	0.00462
100 KeV	1.00E+05	0.5482	1.00E+05	0.01460
1 MeV	1.00E+06	0.9411	1.00E+06	0.04614
10 MeV	1.00E+07	0.998818	1.00E+07	0.14486
100 MeV	1.00E+08	0.999987	1.00E+08	0.42825
1 GeV	1.00E+09	0.9999999	1.00E+09	0.87507
10 GeV	1.00E+10	1.0000000	1.00E+10	0.99632
100 GeV	1.00E+11	1.0000000	1.00E+11	0.99996
1 TeV	1.00E+12	1.0000000	1.00E+12	1.0000000

Conservation Laws

- The total energy and momentum of a system are preserved

$$E = \sum_i E_i = \text{const}; \vec{P} = \sum_i \vec{p}_i = \text{const} \Leftrightarrow P^\mu = \sum_i p_i^\mu = \text{const}$$

- And equation of motion for a particle are:

$$\frac{d\vec{p}}{dt} = \vec{F}; \quad \frac{dE}{dt} = (\vec{F} \cdot \vec{v});$$

- With Lorentz force it becomes (in SGS system):

$$\frac{d\vec{p}}{dt} = q \left(\vec{E} + \frac{\vec{v}}{c} \times \vec{B} \right); \quad \frac{dE}{dt} = q (\vec{E} \cdot \vec{v});$$

Every rapidly advancing field has its logarithmic plot: example is the Moore Law Plot

Microprocessor Transistor Counts 1971-2011 & Moore's Law

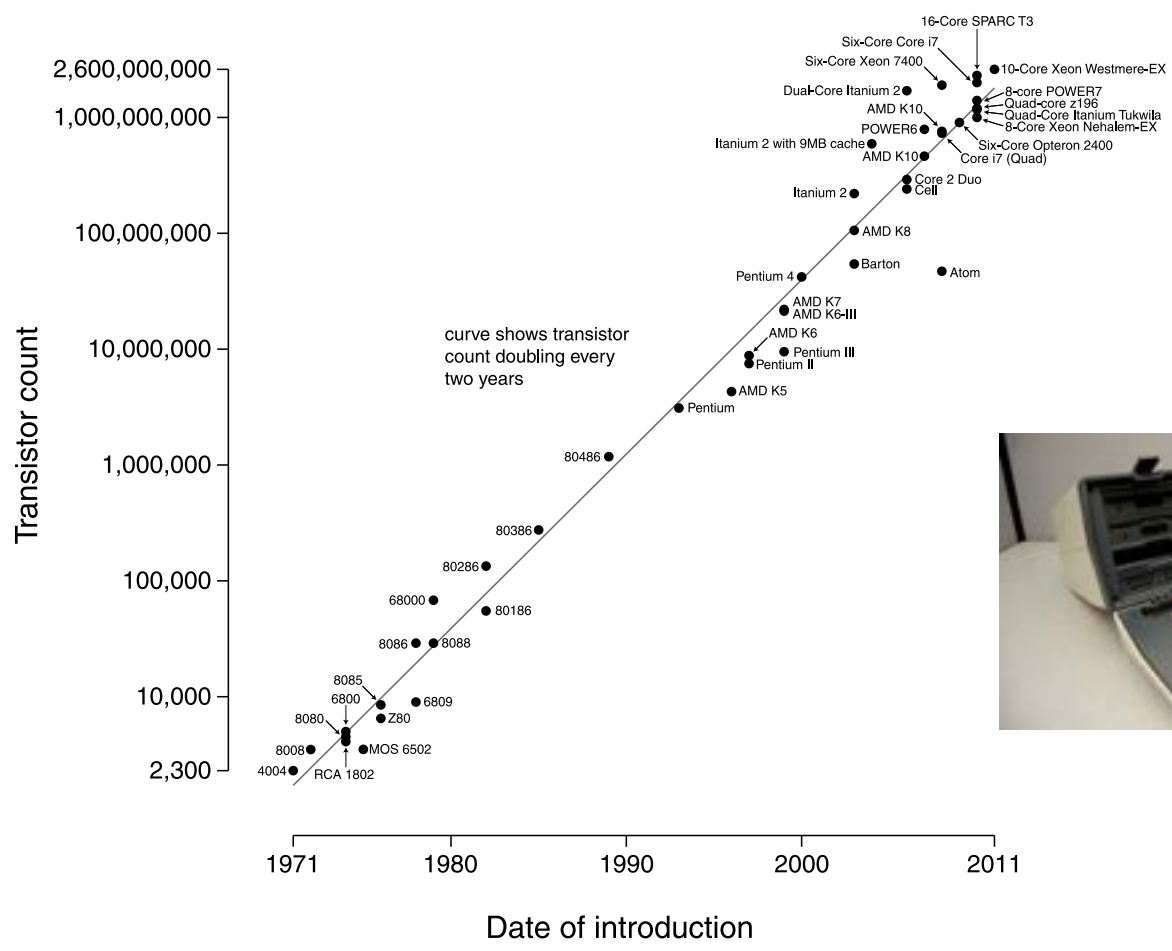

Plot of CPU transistor counts against dates of introduction.
 Note the logarithmic vertical scale; the line corresponds to exponential growth with transistor count doubling every two years.

Two Moors laws for accelerator plots: Livingston plot for C.M. energy and peak brightness plot for light sources

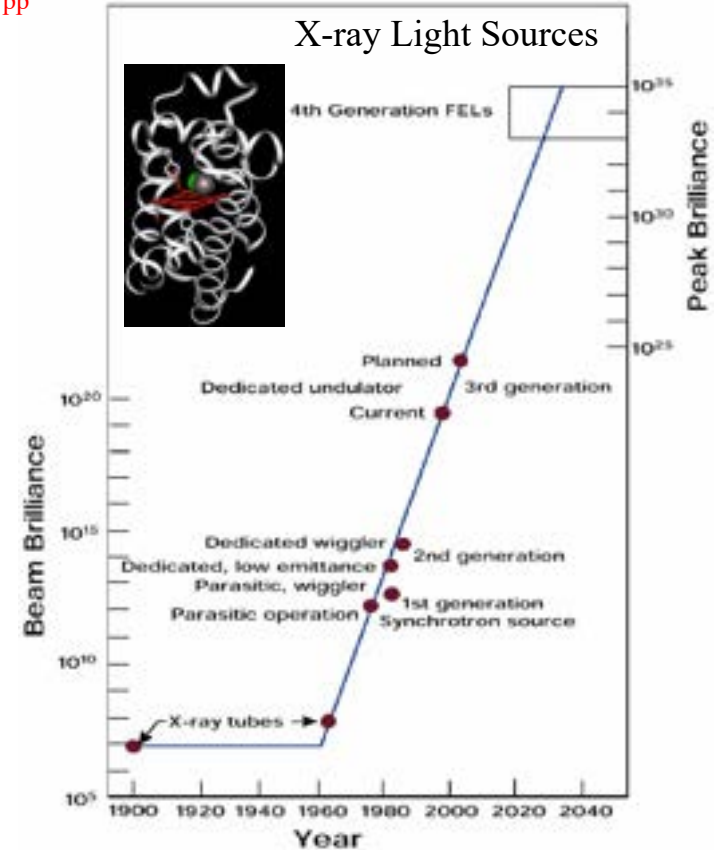
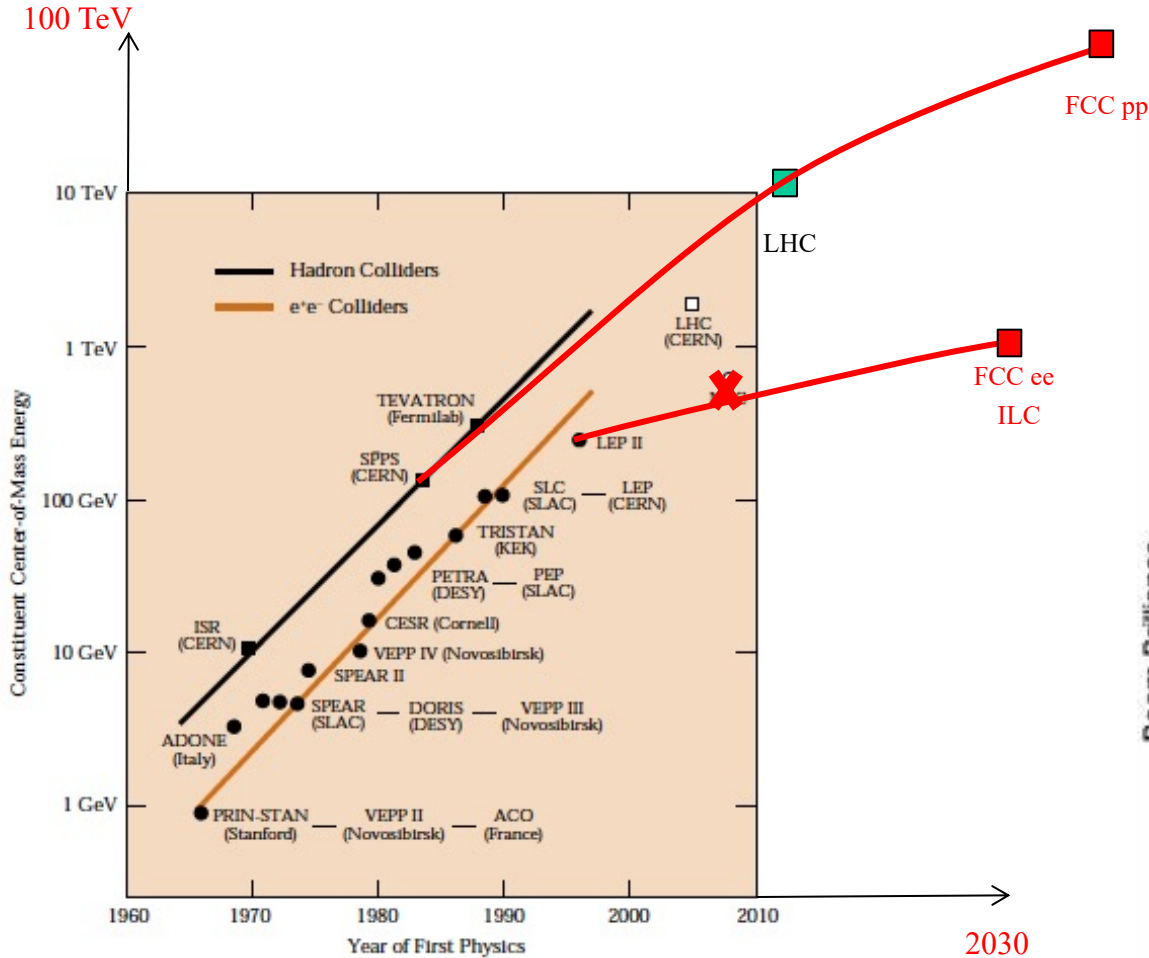

by WOLFGANG K. H. PANOFSKY

Why accelerator (particle) energy is a figure of merit²⁷ for fundamental physics ?

First: it allows us to probe matter at smaller and smaller
distances

Probes

$$\Delta p \cdot \Delta x \sim \hbar; \Delta p \sim E / c$$

$$\Delta x \sim \frac{\hbar c}{E} \sim \frac{1 \mu\text{m}}{1 \text{eV}}$$

Radiation	Energy	Wave length	Structures
Terahertz Radiation	10 meV – 100 meV	10 ⁻⁴ m	Human body
Visible light	1 eV – 3 eV	10 ⁻⁶ m	Cells
X-rays, electron microscope	- 10 keV	10 ⁻¹⁰ m	Crystals, Atoms
Medium-energy accelerator	- 100 MeV	10 ⁻¹⁴ m	Atomic nucleus
High-energy accelerator	- 100 GeV	10 ⁻¹⁷ m	Nucleons, hadrons

Resolution

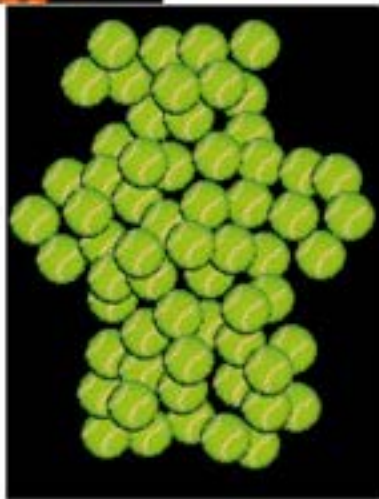
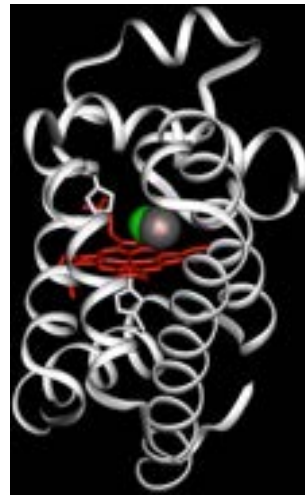
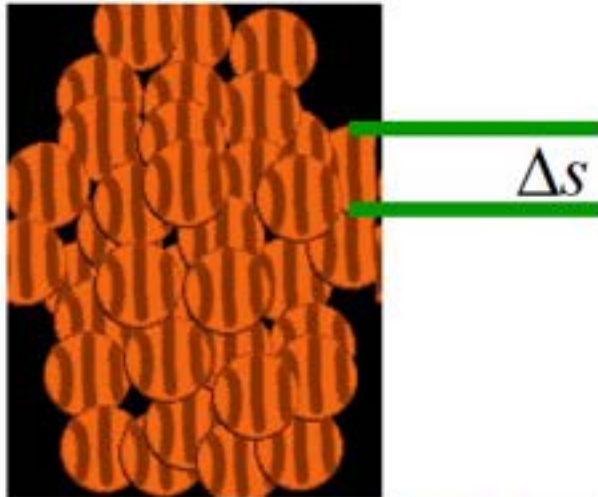

$$E = h\nu = h \cdot \frac{c}{\lambda} = 2\pi \frac{\hbar c}{\lambda}$$

$$\Delta s \geq \lambda = \frac{\hbar c}{E}$$

Massless particles:

The resolution is inversely proportional to the radiation energy.

Massive particles:

de-Broglie wavelength.

$$\lambda = \frac{h}{p}$$

$$\Delta s \geq \lambda = \frac{h}{p} = \frac{h}{\gamma m v} = \frac{h}{\gamma m v}$$

$$\lambda = 2\pi \frac{\hbar c}{pc} = 2\pi \frac{197 \text{ MeV fm}}{pc}$$

Why accelerator (particle) energy is a figure of merit for fundamental physics ?

Second: it allows us to create new heavy particles.

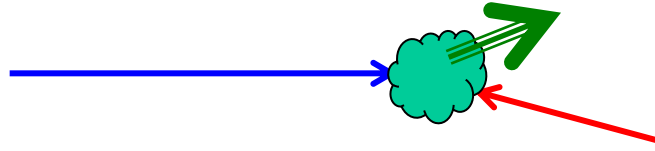

The minimum energy required to create a particle (or group of particle) with total mass M is:

$$E_{\min} = Mc^2; \quad M = \sum m_i$$

In practice the energy of colliding particles must be higher, both to allow the created particles to separate and, in some geometry, to have energy for their common motion.

Fixed target experiments

A particle from an accelerator is directed towards a stationary particle:

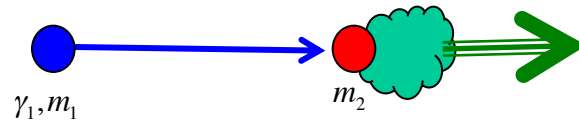

In the co-moving frame of created particles the energy is equal to (or exceeds) Mc^2

The conservation of the energy states that

$$E = \gamma_1 m_1 c^2 + m_2 c^2; \quad \vec{P} = \gamma_1 m_1 \vec{v}_1; \quad \gamma_1 = 1 / \sqrt{1 - \vec{v}_1^2 / c^2}$$

and the available energy for creating particles is

$$M_{\text{eff}}^2 c^4 = E^2 - \vec{P}^2 c^2 = (m_1 c^2)^2 + 2\gamma_1 m_1 c^2 m_2 c^2 + (m_2 c^2)^2$$

$$\gamma_1 \gg 1 \Rightarrow 2\gamma_1 m_1 c^2 m_2 c^2 \gg (m_1 c^2)^2 + (m_2 c^2)^2 \Rightarrow M_{\text{eff}} c^2 \cong \sqrt{2E_1 m_2 c^2}$$

with most of the energy lost for the common motion of the products of the reaction

Collider experiments

A particle from an accelerator is directed towards a stationary particle:

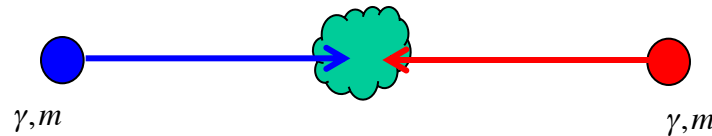

The conservation of the energy states that

$$E = 2\gamma mc^2; \quad \vec{P} = \gamma m\vec{v} - \gamma m\vec{v} = 0;$$

and the available energy for creating particles is maximized

$$\left(M_{eff}c^2\right)^2 = \left(2\gamma mc^2\right)^2 - 0 \Rightarrow E_{CM} = M_{eff}c^2 = 2\gamma mc^2 = E_1 + E_2$$

Achieved: e^+e^- - 200 GeV; $p\bar{p}$ - 2 TeV; pp - 13 TeV

Colliders and their effective energy

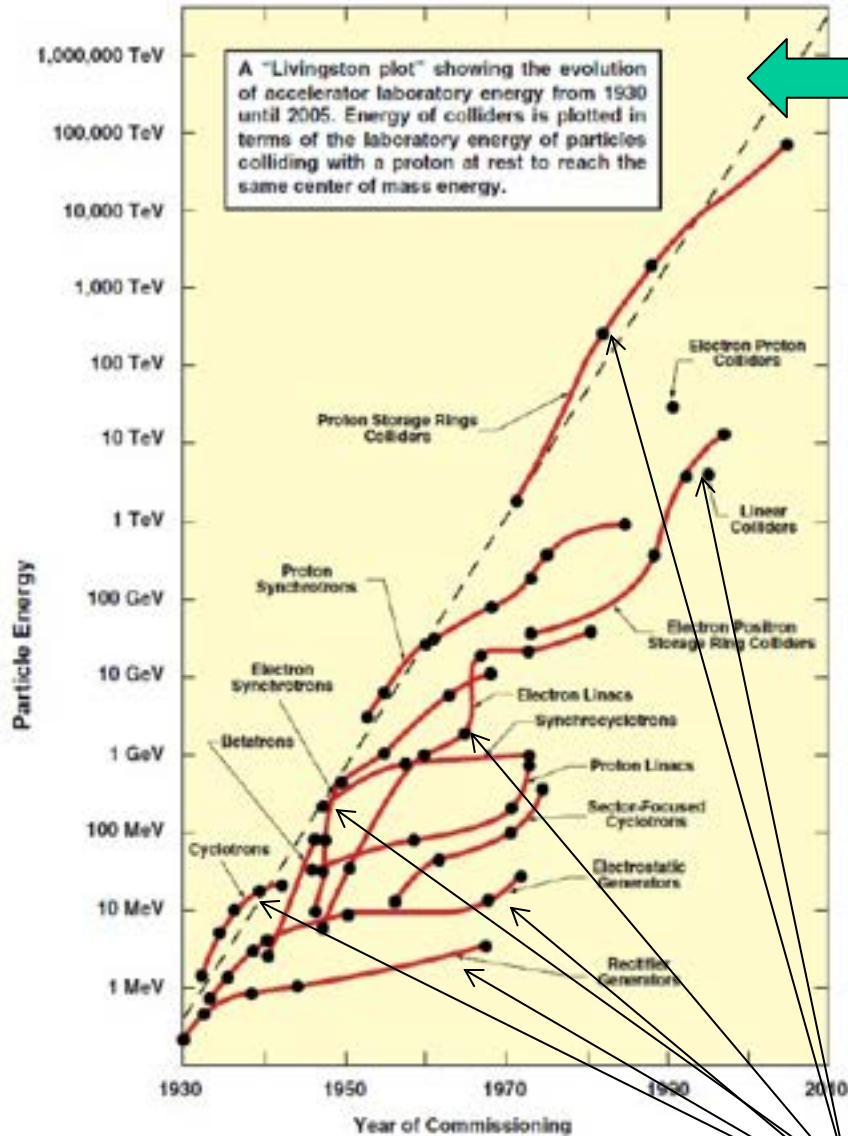

Courtesy: Stanley Livingston

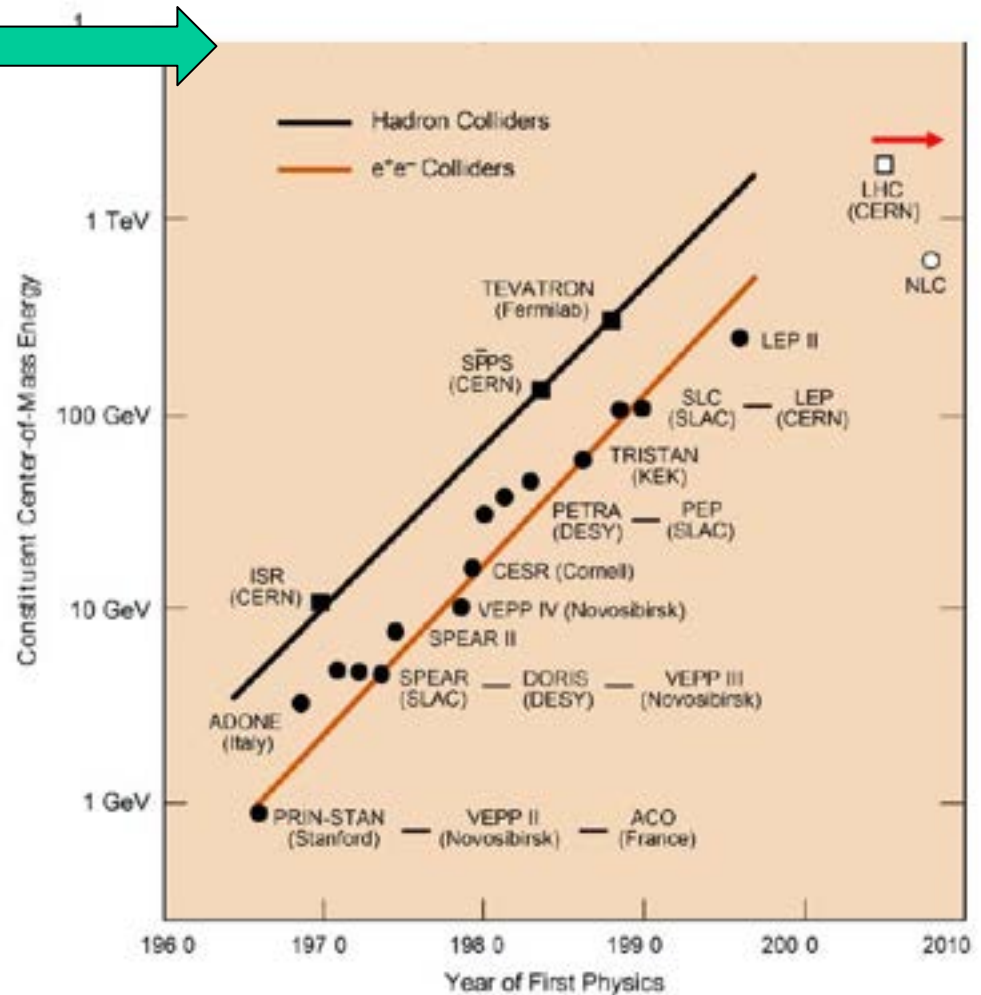

Courtesy: Stanley Livingston

We will discuss some (but not all!) of these branches

There is hope that new techniques will flourish in 21st century

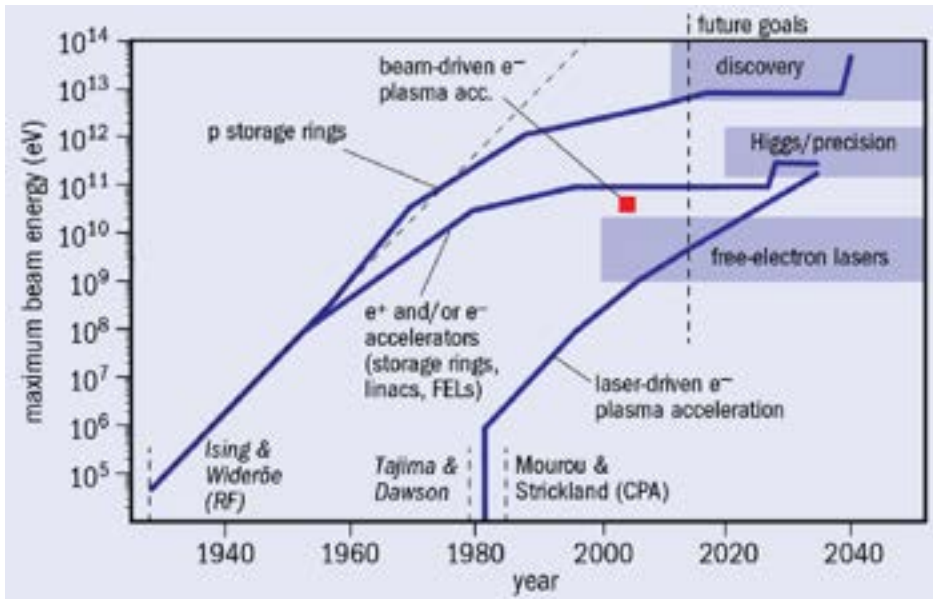

Plasma-based (PWA) accelerators rapidly progressing in the attainable energy

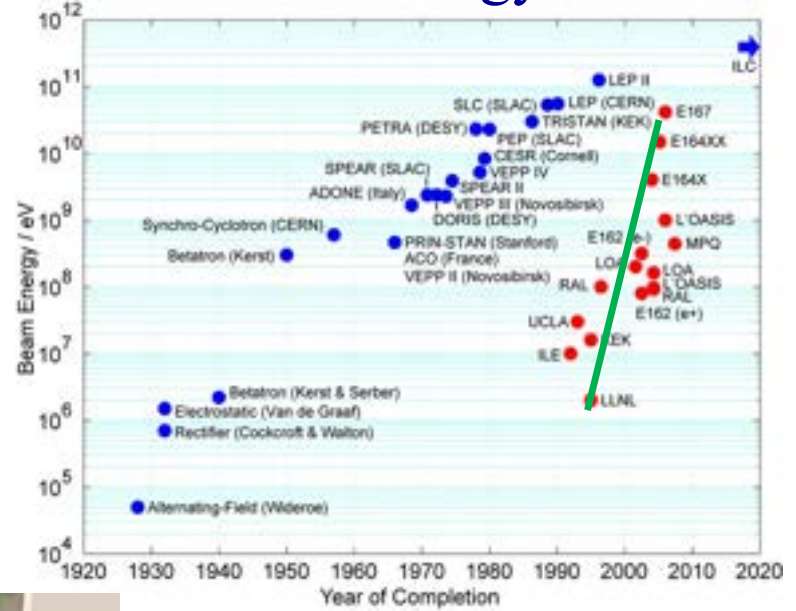

Both laser- and beam- driven PWA have problem of producing reliable high-quality beams. But this is the current focus of accelerator

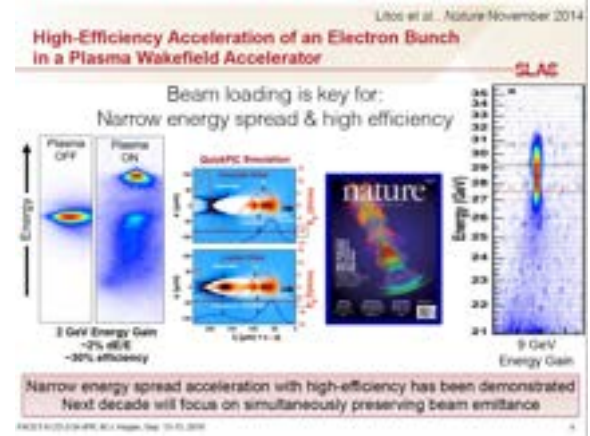
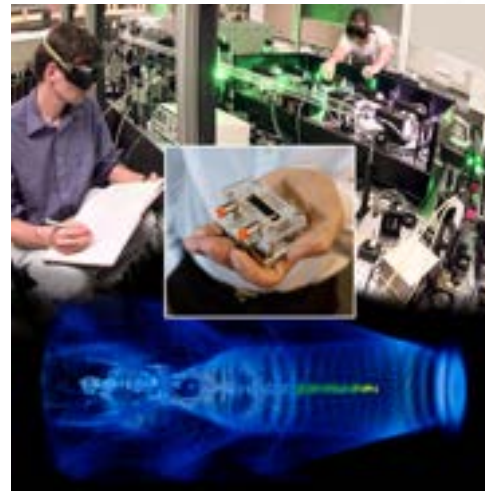

Topics for next class

- Why people do not use colliders all the time?
- Why CEBAF (12 GeV electron accelerator at JLab) will slam the beam in to a “solid brick”?
- What figures of merit beyond accessible CM energy are important for high energy and nuclear physics?
- What is the figure of merit of accelerators as light sources?

Summary

- We accelerate – most of the time – stable charged particles
- Accelerators are intrinsically relativistic devices: electrons start moving with relativistic velocities after accelerating to few kV, while 2,000-fold heavier protons need MeV scale energy boost to move to a portion of the speed of the light
- Collider geometry provides access to significantly higher CM energy compared with colliding accelerated beam with a stationary target
- Accelerators followed Moor's Law for many decades in 20th century, but now we are reaching technology, geometry (confined to the Earth) and financial limits
- **Following best PHY 554 traditions – no HWs during first class**