

# PHY 554

## Fundamentals of Accelerator Physics

### ▫ Lectures 2 & 3: History of Accelerators

Vladimir N. Litvinenko

We are discussing development of accelerators and learning “accelerator slang”. The main goal of this brief overview is to introduce you to inventive nature of the accelerator physics and engineering: each time there is a “dead-end”, accelerator community finds way of going further.

It never was an easy path, but so far we were very successful.

It is for your generation to figure out the next breakthrough.

*There are books and long articles written about the history of accelerators. Here we are recall some elements of the history as it fit the purpose of our course: without any attempt to follow neither the historical order of events nor the importance of the new inventions.*

# 19<sup>th</sup> century

**First man-made accelerators** were naturally electrostatic and accelerated electrons— e.g. were both generated and accelerated by applying high voltage. First were cathode tubes, which generated so-called cathode rays (see more on [http://www.brooklyn.cuny.edu/bc/ahp/LAD/C3/C3\\_Electrons.html](http://www.brooklyn.cuny.edu/bc/ahp/LAD/C3/C3_Electrons.html)). What is probably most remarkable that initially people used batteries for this experiments – AC current was not yet readily available

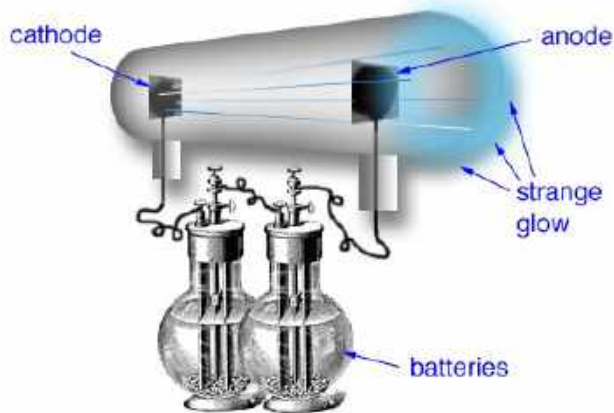

*German glass blower's - Heinrich Geissler - apparatus consisted of a glass tube in which an anode (the positive pole, or plate) was at one end, and the cathode (the negative pole, or plate) was at the other end. His superior vacuum pump removed all the air from the tube, and he connected the anode and the cathode to the appropriate ends of a powerful battery. At high enough voltages electricity certainly seemed to be able to leap across the vacuum between the oppositely charged plates, but that was not all. On the wall opposite to the negative cathode, the glass glowed a strange, greenish color*

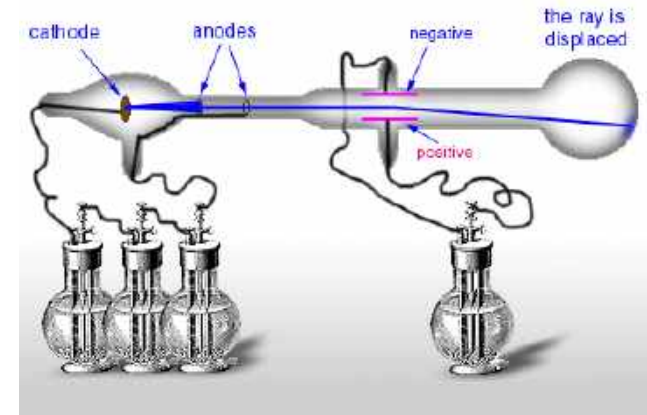

- William Crookes, among several others showed that **bringing a magnet next to the sides of the tube caused the cathode rays to bend** in a way that strongly suggested that they were made up of electrically charged particles - not waves.
- English physicist Joseph John Thomson carried out a series of experiments using tube that incorporated two small plates, between which the rays had to travel. By connecting these plates to a battery, an electric field was generated and the rays were bent! **In 1897 J.J. Thomson** announced that the cathode rays consisted of negatively charged particles (which he called "corpuscles") that were only less than 1/1000th of the mass of a hydrogen atom. This was something very new. **Thomson was awarded the Nobel Prize in 1906** for his "discovery" of the first sub-atomic particle; **the electron**.
- **Thus, 19<sup>th</sup> century reached energies in accelerators ~ 10 KeV, e.g. ~1e4 eV.**
- Next century had to increase it to ~few TeV. e.g. > 1e12 eV, a 100,000,000 increase.

## 1<sup>st</sup> half-of-20<sup>th</sup> century: from electrostatic cans to synchrotrons



*Billions of these tubes were made in 20<sup>th</sup> century – now most of them are in the landfills*



- Usually the development of accelerators is seen through a looking glass of their users – high-energy or nuclear physicists, synchrotron radiation users or material scientists. Here I present it from point of view of the accelerator science.

# 1<sup>st</sup> half-of-20<sup>th</sup> century: from electrostatic cans to synchrotrons

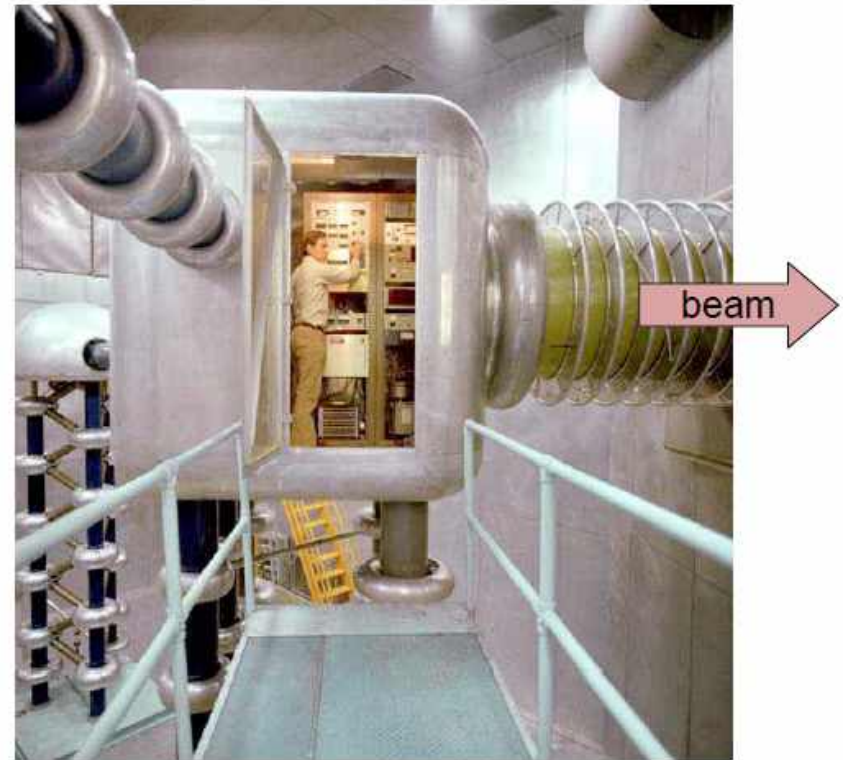
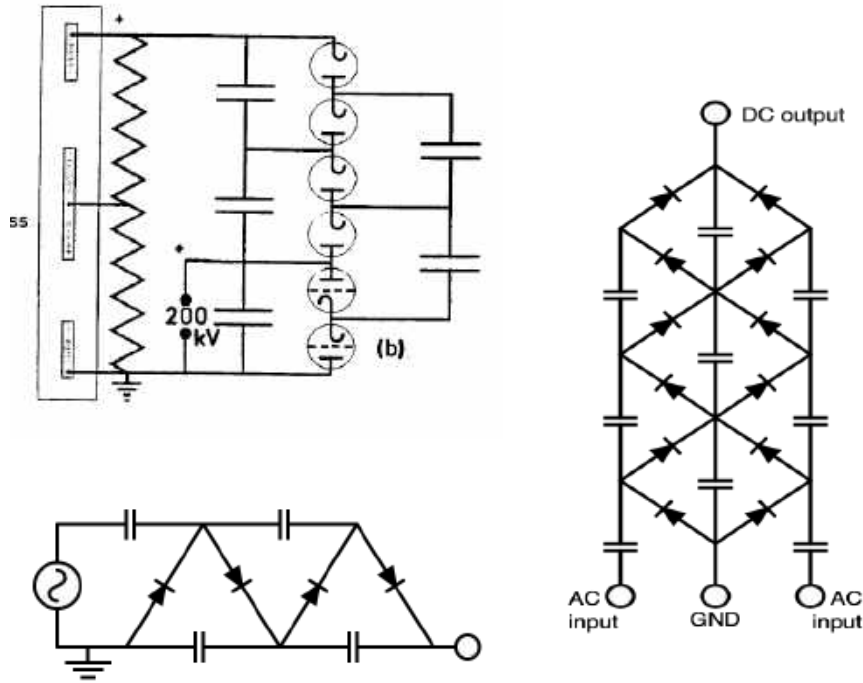

Crockcroft-Walton at FNAL accelerates  $H^-$  to 750keV

In 1928 Cockcroft & Walton propose an AC connected DC rectifier accelerator which multiplied applied voltage (later wide use of AC current made it even simpler) and in 1932 reached voltage of 700 kV where they accelerate protons and split Li atoms. *At about the same time Van de Graaff invented an electrostatic generator, which reached a potential of 1.5 MV*

# 1<sup>st</sup> half-of-20<sup>th</sup> century: from electrostatic cans to synchrotrons

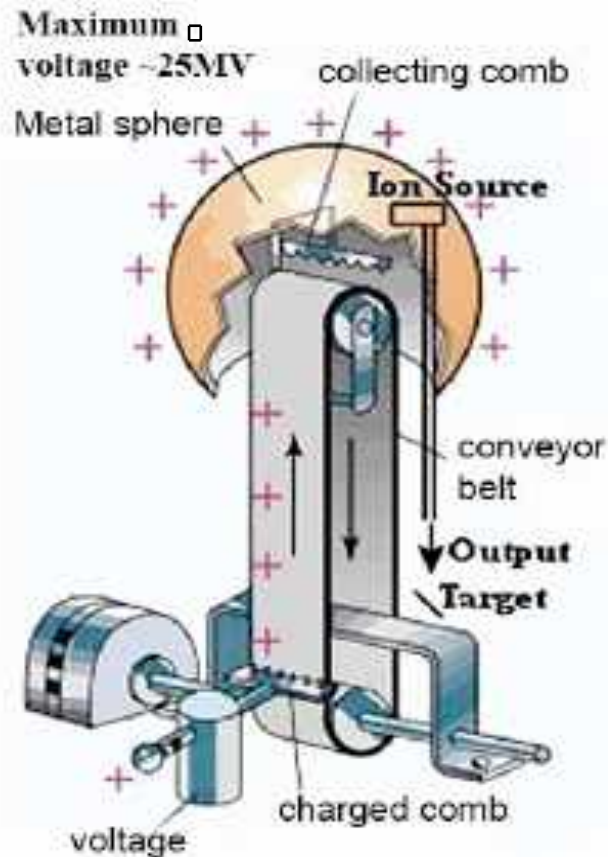

(Photo: CCLRC).



*Left: Van de Graaff invented an electrostatic generator*

*Middle and right: one of the biggest tandem accelerators at Daresbury (UK) with 42 m (14 stories high) 20 MV acceleration tube, placed vertically*

# Hitting the roof!

What's wrong with this picture?

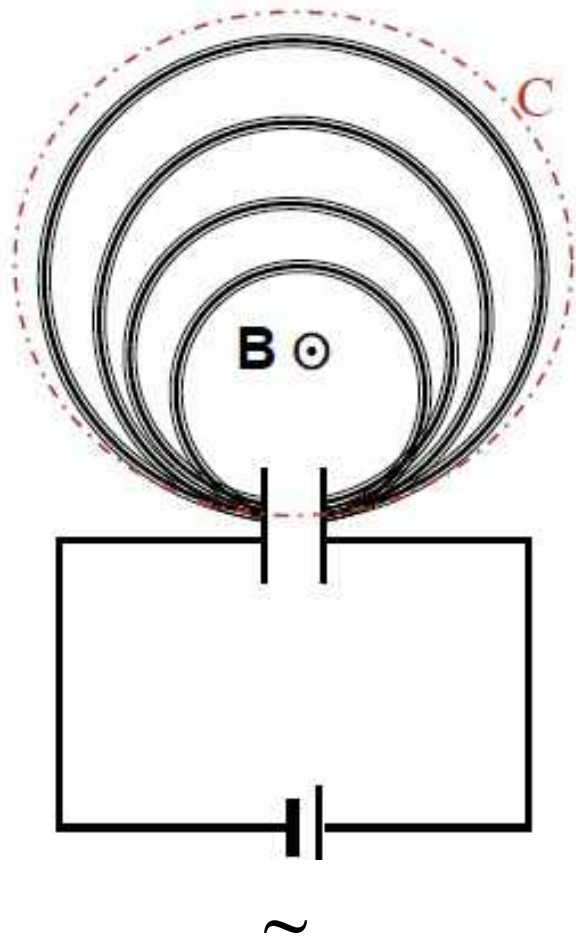

The limits of the electrostatic accelerator – otherwise very powerful and technologically simple – comes from a simple fact that one can not accelerate twice (or multiple times) a charged particle in the same DC accelerating gap – e.g. it requires to have full accelerating voltage applied to the terminal – thus the dimensions in all directions scale with its voltage. Maximum electric field is usually limited by electric break-down  $\sim 10$  kV/cm - e.g. one needs at least 20 m for a 20 MeV accelerator.

- *In addition, one should just observe a lightning to understand how dangerous such devices could be for a decent conductors, like human bodies*

# Hitting the roof!

One unusual exception is idea of a tandem, which accelerate a negatively charge ions (like H<sup>-</sup>) from the ground to the positively charged terminal, strip the electrons from the ions using a thin foil and accelerating positively charged ion (like H<sup>+</sup>) to the twice the total voltage, just proved the rule. One of the simplest Maxwell equations forbids this option with a rigor close to the non-existence of Perpetuum mobile



$$\Delta E = e \oint \vec{E} \cdot d\vec{l} = -\frac{e}{c} \frac{\partial}{\partial t} \left( \int \vec{H} \cdot d\vec{s} \right) \quad (2.1)$$

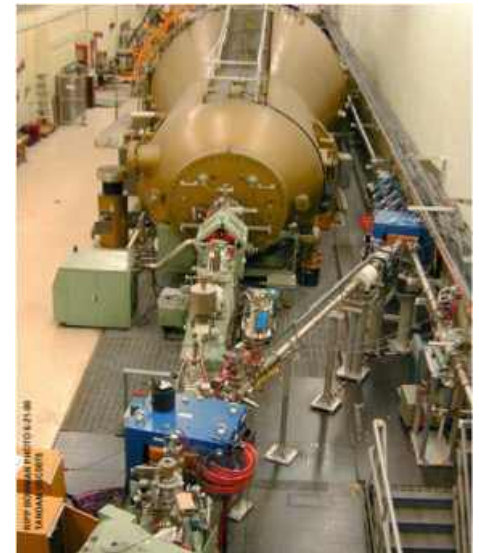

- *Does not matter how much fun is electrostatic and how many good electrostatic “dinosaurs” are in basements of our universities, Maxwell equation prohibits multiple acceleration in any DC EM field with  $\vec{E} = \text{const}; \vec{B} = \text{const}$*

# 1<sup>st</sup> half-of-20<sup>th</sup> century: from electrostatic cans to synchrotrons

Naturally – as the history of accelerator science proves now and again – there are physicists who find a solution for accelerating particles without creating “total voltage problem”. What is also remarkable that these developments were parallel to that of electrostatic accelerators.

In 1924 Ising proposed using time-varying fields, which later got name of RF linacs (Radio Frequency linear accelerators, or simply: linacs).

In 1928 Wideröe demonstrates first RF linac using a 1 MHz, 25 kV oscillator for 50 keV linac accelerating potassium ions.

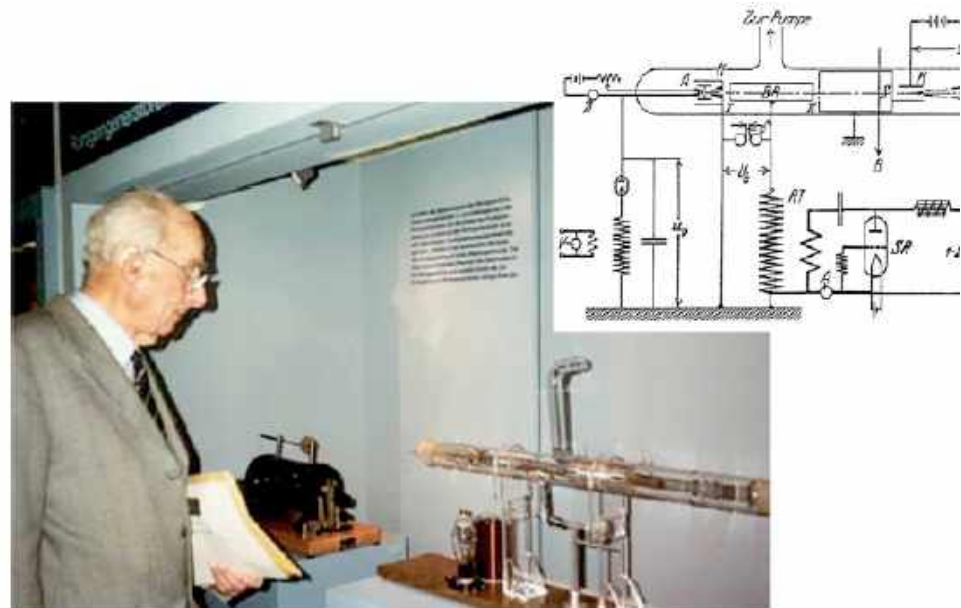
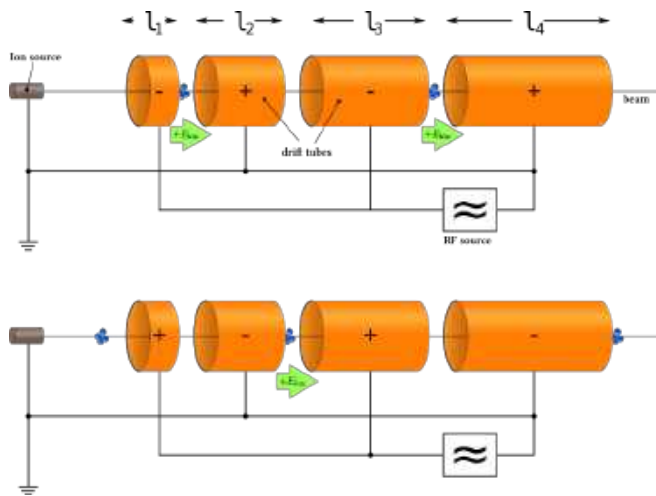

- *Wideröe's linac for slow particles – the particles are shielded from the reverse field by a conducting tubes (which are a part of the RF resonant circuit!) and see only accelerating voltage. Thus, with total “applied” voltage  $V$  per of  $N$  cell, particle with charge  $q$  get  $N \cdot q \cdot V$  energy boost.*



## 2<sup>nd</sup> half-of-20<sup>th</sup> century: from electrostatic cans to synchrotrons

Alvarez followed up by suggesting linac with drift tubes, which were not grounded, and many more advanced schemes emerged later – needless to say, all using the non-zero value of  $\text{curl}\vec{E}$ . The RF linac technology grew-up dramatically through 20th century - benefiting heavily from powerful RF transmitters developed for military radar applications - and modern pulse linear accelerator reaching accelerating gradient exceeding 150 MeV per meter

### ➤ Compare it with 1 MV/m in DC accelerators



SLAC 2-mile linear accelerator

- This "resonant acceleration" becomes easier when particles getting to relativistic velocities, which happens in electron linacs. Many radiation treatments facilities in hospitals treating cancer patients have so-called medical linacs generating bremsstrahlung gamma-ray beam by slamming  $\sim 15$  MeV electron beam into a metal target. In 1960<sup>th</sup> SLAC built 2-mile (3.2 km) linear accelerator (above), which reached energy up to 50 GeV in a single pass of electrons and positrons.

## 2<sup>nd</sup> half-of-20<sup>th</sup> century: from electrostatic cans to synchrotrons

CW accelerators have more modest – but still impressive – accelerating gradients  $\sim 20$  MeV per meter. Because of the energetics, such accelerators usually operate with Super-conducting RF (SRF) structures, which have very low losses (good super-conducting Nb has  $\sim 1,000,000$  lower losses than a very good Cu). European X-ray FEL (free-electron laser) in Germany facilities uses SRF linacs – US followed the trend by building CW X-ray FEL driven by SRF linac. SRF even more popular with re-circulating accelerators.

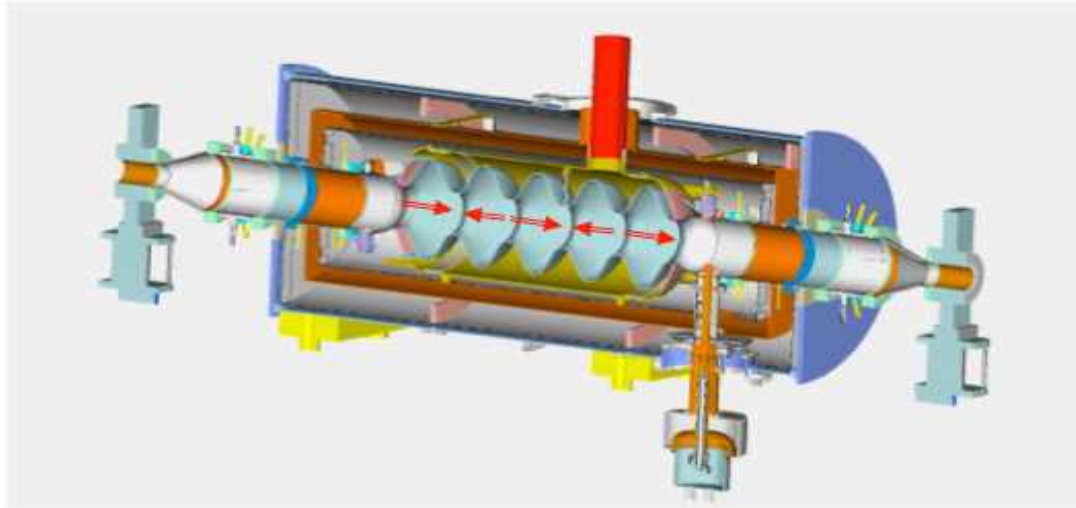

*A 20 MeV Super-conducting RF (SRF) linac at BNL. Electric field had a standing wave pattern oscillating with RF frequency – when electron propagates from one cell to another, electric field changes its direction and electron continues accelerating in each cell.*

- Protons and ions are much more stubborn – they are moving slowly for quite awhile and hadron linacs are much longer and more complicated than that for electrons (or positrons). Still, there is 1 GeV proton SRF linac was built at Oakridge National Laboratory for a neutron spallation source. You will learn a lot about linear accelerators in next few weeks – hence, the end of this introduction into linear accelerators.

# 1<sup>st</sup> half-of-20<sup>th</sup> century: from electrostatic cans to synchrotrons

Success of Wideröe inspired Lawrence to conceive the cyclotron – a cyclic accelerator where particles are passing through the accelerating RF gap many-many times

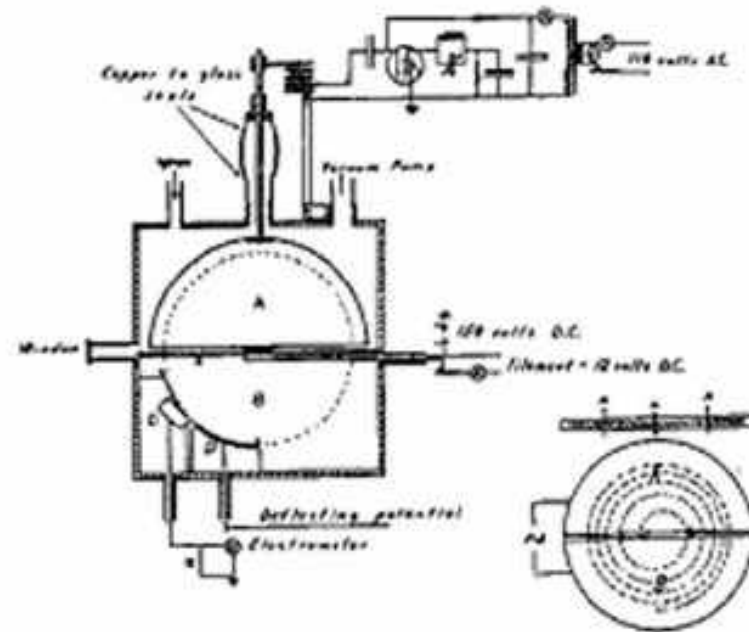
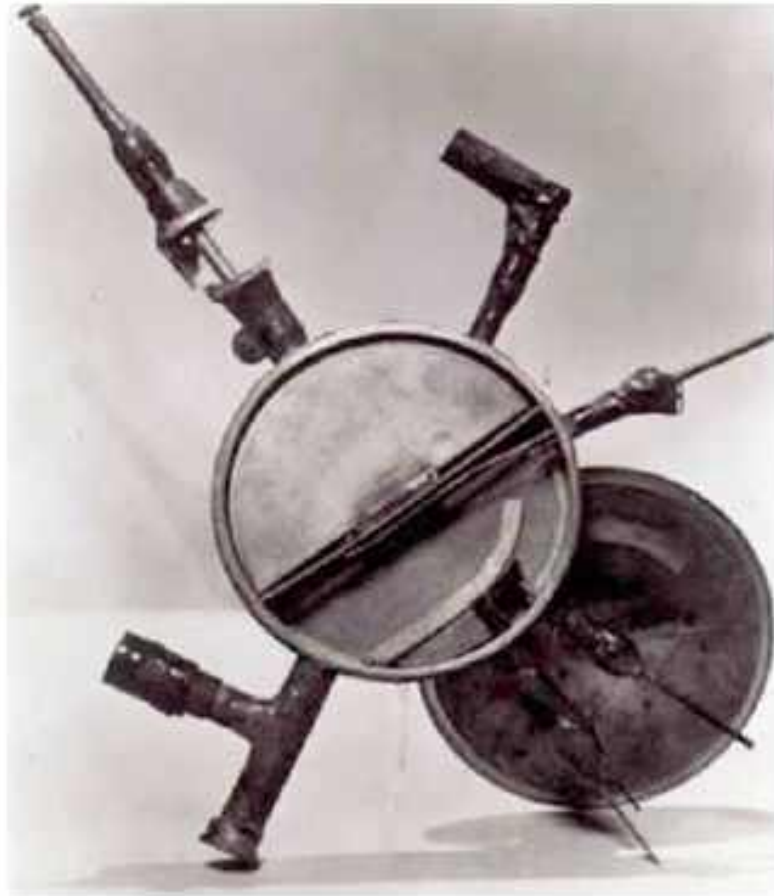

Lawrence, E.O. and Sloan, D.: Proc. Nat. Ac. Sc.,  
17, 64 (1931)

Lawrence, E.O. & Livingstone M.S.: Phys. Rev 37,  
1707 (1931).

*First proof-of-principle cyclotron built by Lawrence and the hand-drawing of the machine*

## Cyclotrons are resonant accelerators, initially designed for a non-relativistic particles

e.g. for ions and protons at modest sub-GeV energies. The main idea of Lawrence was based on following – the Larmor precession frequency in a uniform magnetic field for non-relativistic limit does not depend on the particle velocity. Let's derive it for a relativistic particle and then use  $\gamma \rightarrow 1$  limit.

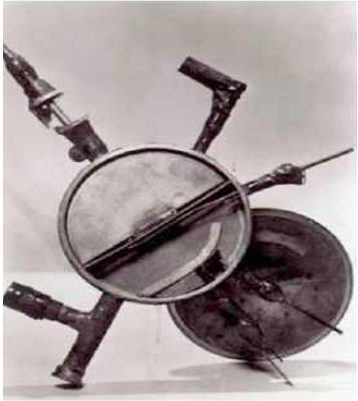

$$\frac{d\vec{p}}{dt} \equiv [\vec{\omega} \times \vec{p}] = -\frac{e}{c} [\vec{v} \times \vec{B}]; \vec{p} = \gamma m \vec{v} \Rightarrow \vec{\omega} = \frac{e\vec{B}}{\gamma mc} \quad (2.2)$$

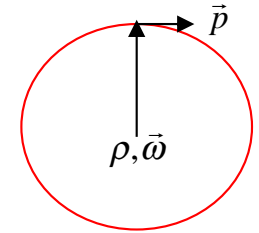

It is a good place to introduce beam rigidity frequently used in accelerator physics books and papers. From eq. (2.2) we can easily find the radius of the trajectory  $\rho$ :

$$\omega = \frac{eB}{\gamma mc} = \frac{v}{\rho} \Leftrightarrow \rho = \frac{pc}{eB}; \quad p = \gamma mv, \quad (2.3)$$

and to define the easy-to-remember **beam (particle) rigidity**:

$$B\rho = \frac{pc}{e} \Leftrightarrow \left\{ \begin{array}{l} B\rho [kGs \cdot cm] = \frac{pc [MeV]}{0.299792458} \cong \frac{pc [MeV]}{0.3} \\ B\rho [T \cdot m] = \frac{pc [GeV]}{0.299792458} \cong \frac{pc [GeV]}{0.3} \\ B\rho [T \cdot km] = \frac{pc [TeV]}{0.299792458} \cong \frac{pc [TeV]}{0.3} \end{array} \right\} \quad (2.4)$$

Just to remind you, the energy measured in eV (SI units) is engineering preference – physicists will be <sup>13</sup> very happy with Gs·cm (SGS units) or even with Heaviside e=m=c=1. But eV are used and we can transferred into J (1J =10<sup>7</sup> erg) by remembering the charge of electron to be: e= 1.60217657·10<sup>-19</sup> C and 1J=1C·1V. Hence 1 eV 1.60217657·10<sup>-19</sup> J. Two most important rest mass energies are:

$$\begin{aligned}
 m_e c^2 &= 0.510998910 \text{ MeV} \approx 0.511 \text{ MeV} \\
 m_p c^2 &= 938.272046 \text{ MeV} \approx 0.938 \text{ GeV} \\
 m_p / m_e &= 1836.1526 \approx 1,836
 \end{aligned}
 \tag{2.5}$$

One should note that the top (2.4) equation in the {} mixes units from SGS (Gs, cm, frequently preferred by physicists ) and SI (Volt, preferred by engineers) system, while the middle has only SI units (T, m, V). The coefficient in the denominator is typical for using SI system where the speed of light

$$c = 2.99792458 \cdot 10^8 \text{ m/s}$$

is (artificially!) eliminated in the Lorentz force equations.

1 GeV = 10<sup>9</sup> eV puts 10<sup>9</sup> back into the ratios between the units, leaving us with c/10<sup>9</sup> = 0.299792458 hanging in the balance. Thus, the coefficient in equation (2.4) is easy to remember it is speed of the light measured in 10<sup>9</sup> m/s.... In any case, whatever trick you use, remember these practical units.

$$\vec{\omega} = \frac{e\vec{B}}{\gamma mc}$$

## Back to cyclotrons:

For  $\gamma - 1 \ll 1$  the particles rotate with constant angular velocity. With the RF frequency  $f_{RF} = \frac{\omega}{2\pi} = \frac{eB}{2\pi mc}$ , the particles will go around and at each pass will pick-up energy in the RF gap. This accelerating principle was very successful for heavy particles and with some modest modification serves some of the most powerful hadron accelerators of today – an PSI (Switzerland) 590 MeV cyclotron is one of the most powerful hadron accelerators in the world. Note here that for nonrelativistic or semi-relativistic particles it is conventional to quote particle's kinetic energy, which goes to zero at rest. For ultra-relativistic particle, the total energy is more natural value.

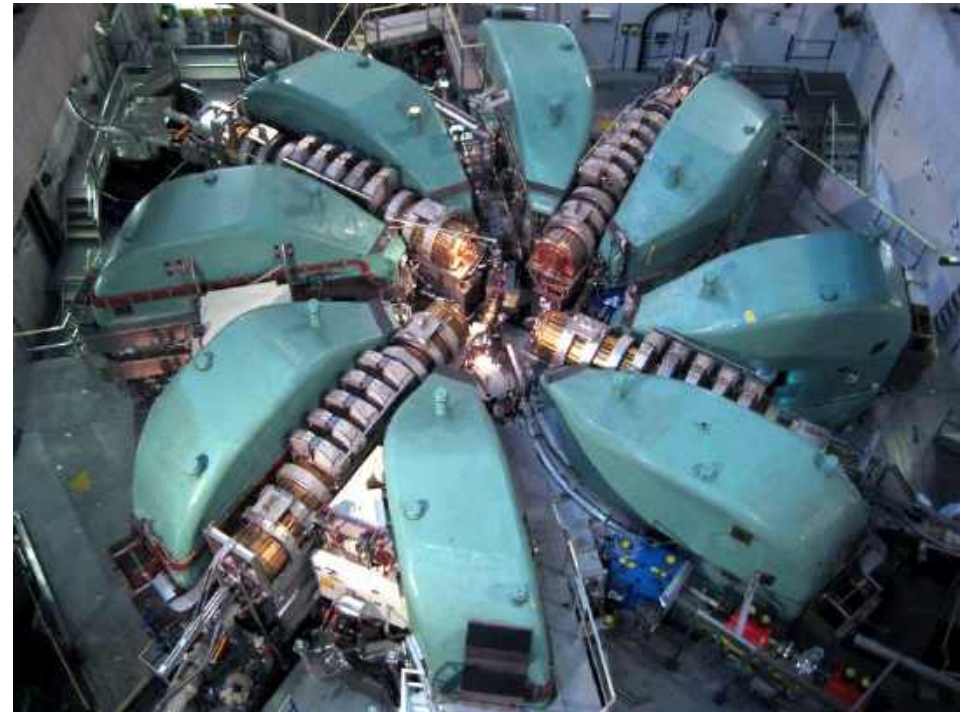
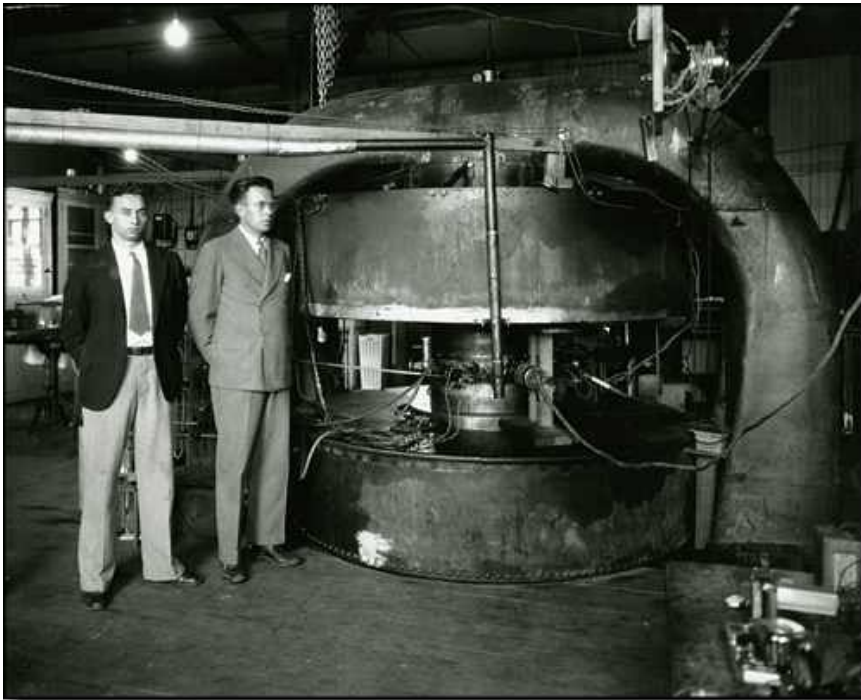

*Lawrence with 27" cyclotron in 1932 (left) and a powerful 590 MeV cyclotron built in early 1970s and still operating in Paul Scherrer Institute (Switzerland) which has a specially shape of magnets to correct for relativistic effects – particle in this cyclotron reach 78.9% of the speed of the light. The later accelerate particles from 72 MeV to 590 in 186 passes (revolutions) – each pass particles gain about 2.8 MeV.*

## Other cyclic accelerators...

Again, not surprisingly, there is a similar resonance scheme, which was created for relativistic electrons – it is called a microtron. The resonance conditions are reached by the following:

$$T_{rev} = \frac{2\pi}{\omega} = \frac{2\pi\gamma_n mc}{eB} = \frac{n}{f_{RF}} \cdot k, \quad n, k \text{ are intergers} \quad (2.6)$$

i.e. the particles gain the same energy per pas in the RF cavity – the change in the energy elongates the travel time by an integer number of the RF period – see figures below

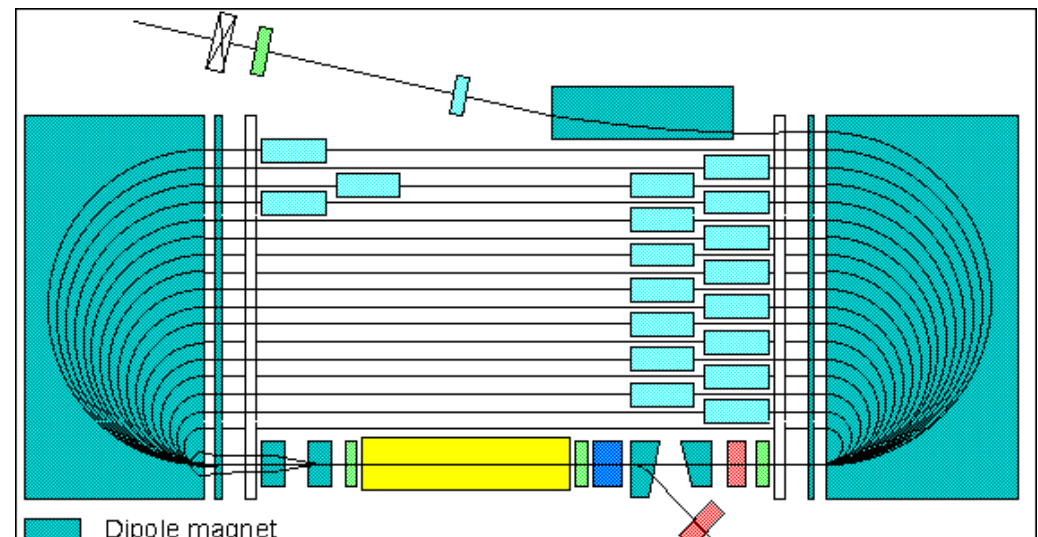
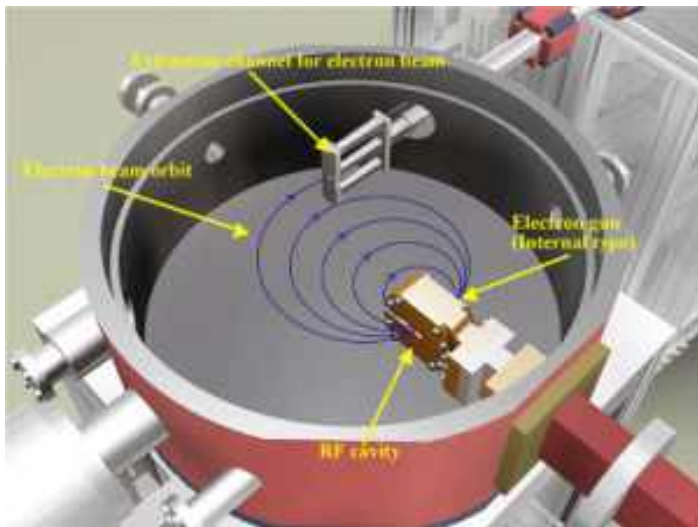

*A classical round (left) and race-track (right) microtrons.*

## Other cyclic accelerators...

Microtrons were predecessors of recirculating linacs. The largest SRF recirculating linac is at Thomas Jefferson Accelerator Facility (JLab, Newport news, Virginia), which will accelerate polarized electron beam to 12 GeV by passing them 5- times through two SRF linear accelerators operating at RF frequency of 1.5 GHz.

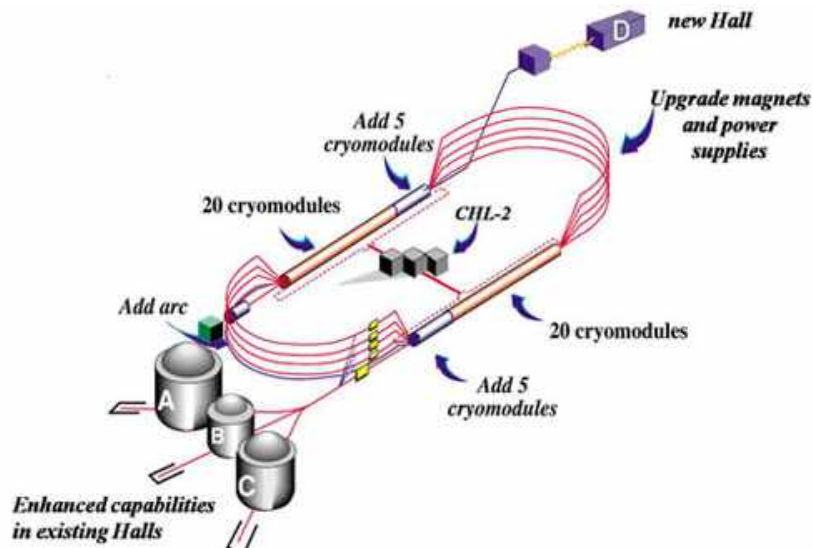

*CEBAF, a 12 GeV recirculating SRF linac at Thomas Jefferson Accelerator Facility. On the right and the bottom – SRF accelerating modules.*





## Other cyclic accelerators... ERLs

Probably most unusual – green and energy efficient – extension of this concept are energy recovery linacs (ERL). The idea – which is very simple in principle, not in implementation! - was suggested by Maury Tigner (Cornell U) in 1965.

It is so simple – since the direction of electric field in linac reverses every half of the RF period, put the accelerated and used particles back into the linac but in the decelerating phase and take the beam energy back. With very low losses in SRF linacs it would turn them into apparent Perpetuum mobile.

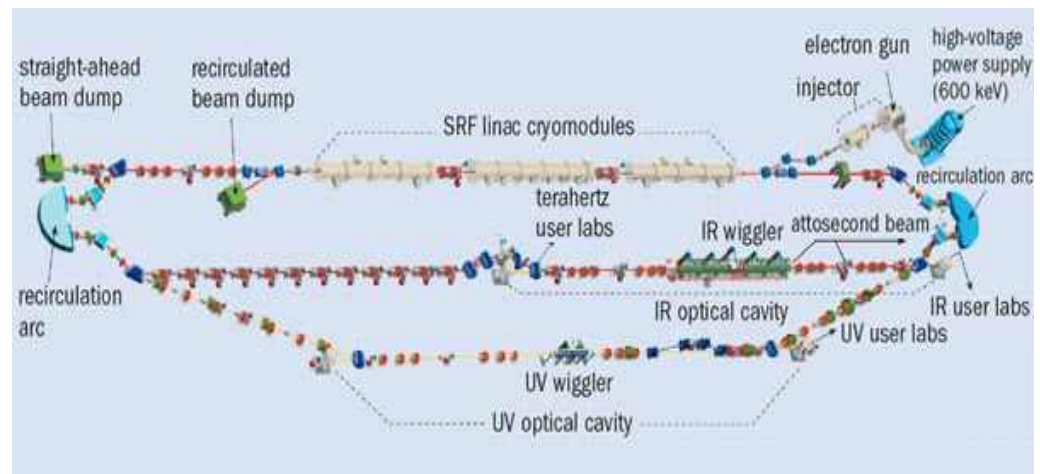
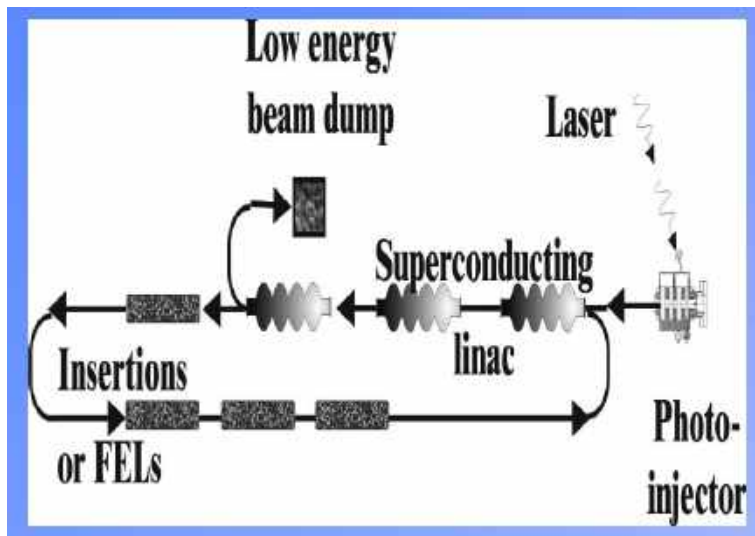

*One of traditional ERL schemes for FELs (left), actual ERL and FEL at Jlab (right)*

It took more than 30 years to implement it in practice with a decent (10 mA) beam current – the problem was that SRF linacs have many high-Q modes which could cause beam instability. Currently there are five ERLs which are operating or were operational – including one at Cornell – and number of them under design or construction.

## ERLs for future colliders

CERN is considering an 60 GeV 3-pass machine for LHeC – an electron-hadron collider at LHC. At CASE we are working on future electron-positrons colliders with energy and particles recycling...

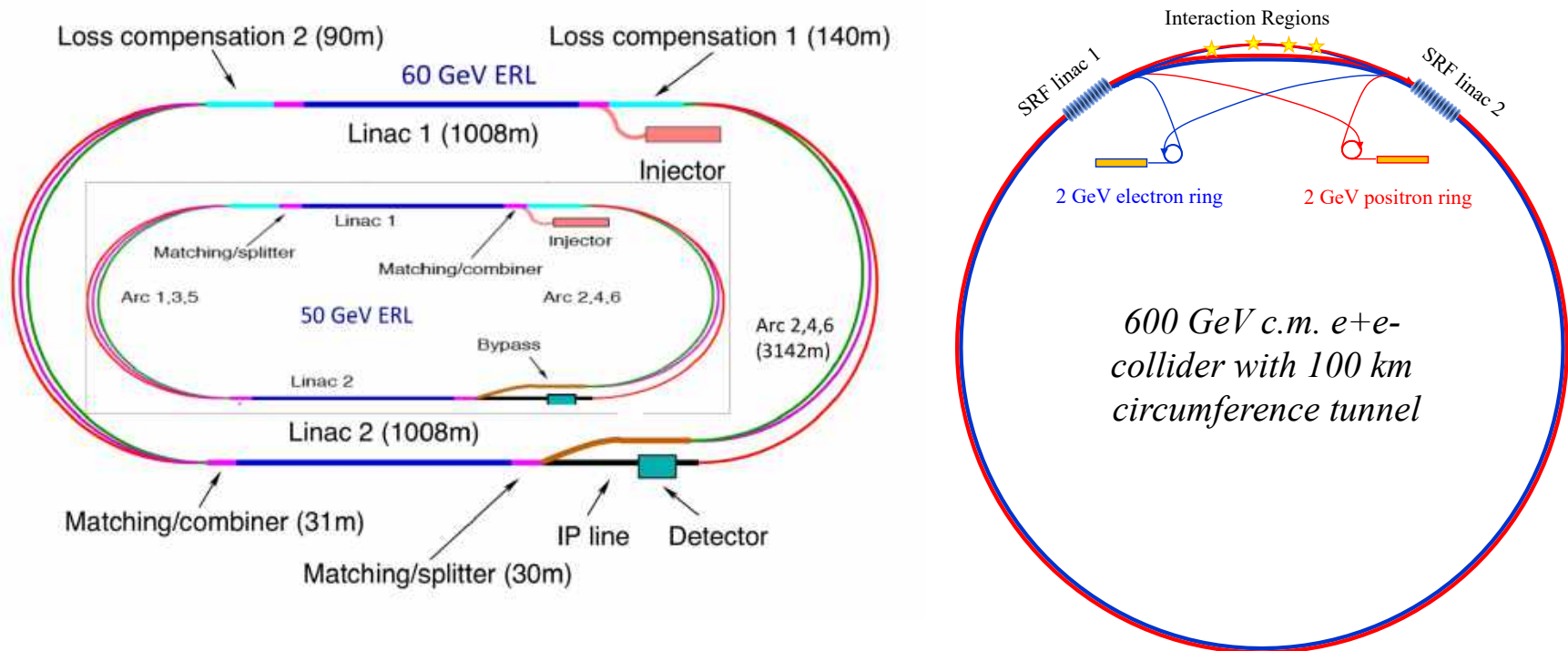

*60 GeV ERL for LHeC (left) and 2x300 ERLs for future electron-positron collider (right)*

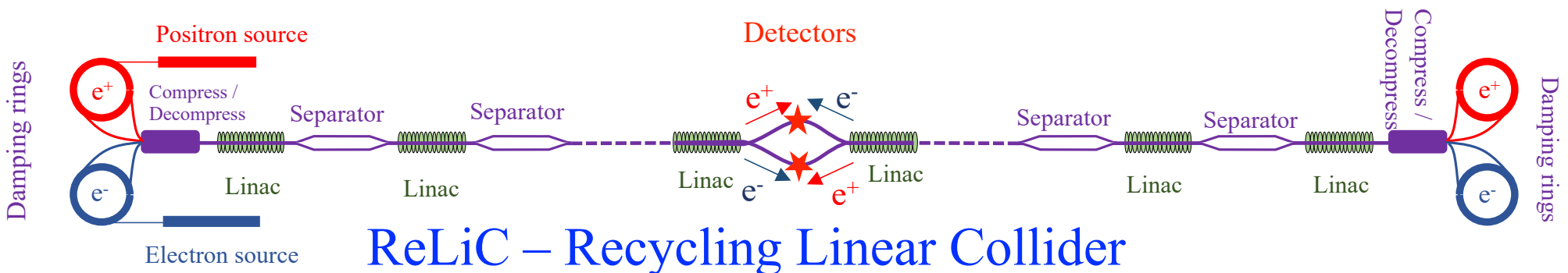

# Bottom line:

In RF cavities, as you will learn in detail in the next classes, the alternating electric and magnetic fields exist naturally in vacuum:

$$\frac{\partial \vec{E}}{c \partial t} = \text{curl} \vec{B}; \quad \frac{\partial \vec{B}}{c \partial t} = -\text{curl} \vec{E}$$

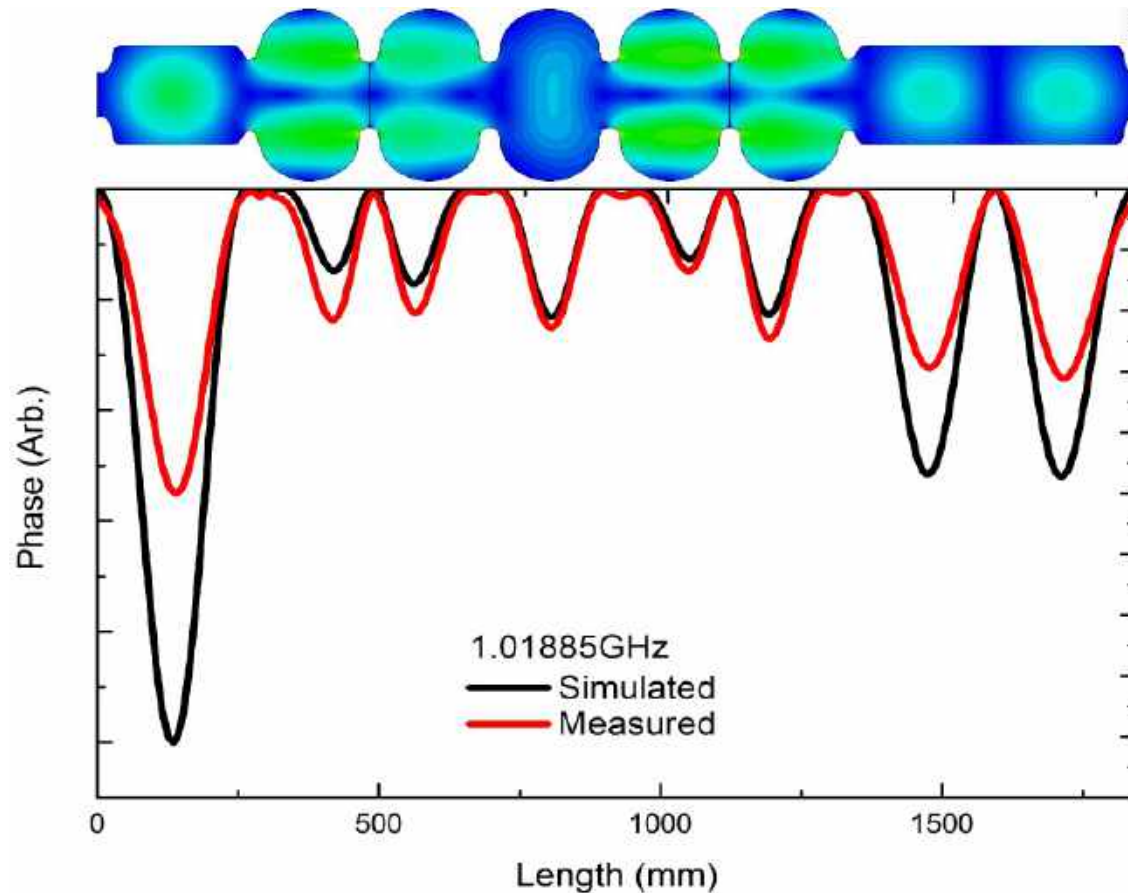

# End of Lecture 2

There is first HW – check it on the course website  
It is due in 2 week

Questions?

# 1<sup>st</sup> half-of-20<sup>th</sup> century: from electrostatic cans to synchrotrons

**Betatron:** (please note that the name is deceptive and this type of accelerator should be called an induction accelerator). There is another way of accelerating particles using induced by alternating magnetic field, e.g. Faraday law

$$e \oint \vec{E} \cdot d\vec{l} = -\frac{e}{c} \frac{d}{dt} \left( \int \vec{H} \cdot d\vec{s} \right)$$

The idea was written in his lab-book by a young Norwegian student, Wideröe, in 1923 but not published. It included 2:1 rule (see next page). Later he added stability criterion. In 1927 he built a model of such betatron but it did not work – and he turned to RF accelerators where he succeeded!

**In 1940 Kerst** re-invented betatron and built a first working 2.2 MeV electron betatron. His largest betatron reached 300 MeV.

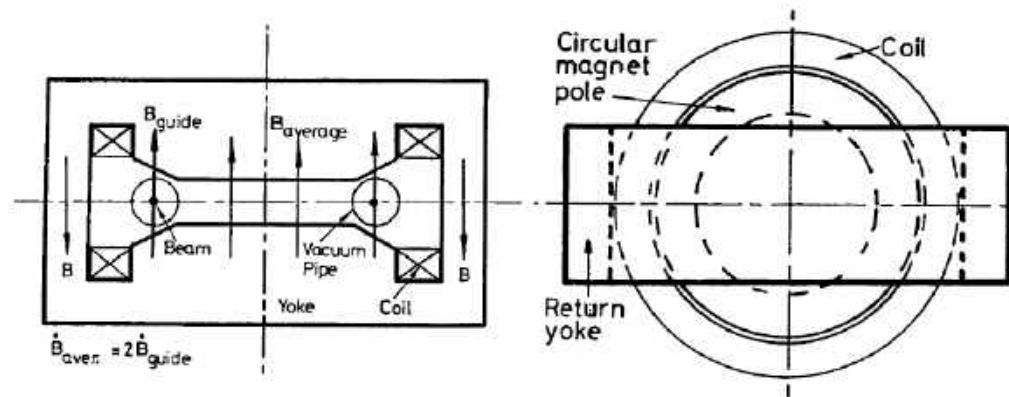

*Schematic of circular betatron (left) and Kerst with his induction (betatron) accelerator (right)*

For an axially symmetric system, the consideration for a constant radius of the particle's orbit are rather simple: an alternating magnetic field induces longitudinal electric field at an radius  $\rho$  :

$$dl = r d\theta; dA = r dr d\theta; \int d\theta = 2\pi; \Phi(\rho) = \oint B_y dA = 2\pi \int_0^\rho B_y(r) r dr$$

$$E_\theta(\rho) = -\frac{1}{2\pi\rho} \frac{1}{c} \frac{d\Phi}{dt} = -\frac{1}{\rho c} \int_0^\rho \frac{dB_y(r)}{dt} \frac{dr^2}{2} = -\frac{\rho}{2c} \frac{d\bar{B}_y}{dt} \quad (2.8)$$

$$\bar{B}_y = \frac{\int_0^\rho B_y(r) r dr}{\rho^2 / 2}$$

Then the change of the particle's momentum:

$$\frac{dp}{dt} = -eE_\theta = \frac{e\rho}{2c} \frac{d\bar{B}}{dt}. \quad (2.9)$$

Let's compare it with eq. (2.3) which we rewrite as

$$p = \frac{eB(\rho)\rho}{c} \quad (2.3')$$

to derive so-called **betatron ratio 2:1**:

$$\bar{B} = 2B \quad (2.10)$$

i.e. the average vertical magnetic field within encircled by the beam trajectory should be twice that on the beam orbit.

*A short detour:* Anybody who tried building room temperature magnets will learn right away that using soft magnetic steel (with permeability  $\sim 1,000!$ ) is the way to go. We will discuss it again in the course. The steel has one important limitation – it saturates at about 2T (20 kGs) magnetic field. After that its permeability plummets and the usefulness of the magnetic steel vanishes. As you will see from the following problem, circular betatrons ramp energy gradually – the acceleration rate limited by the voltage induced in the magnet coils and their possible electric breakdown.

The etymology of many physic's notations – and of course accelerator physics notations – have historic background.

One of these term you would hear and read again and again in accelerator physics talks and text: **betatron oscillations**. It would be natural to call these oscillations transverse since they occur in the directions transverse to the direction of the beam propagation.

But despite the logic they are called “betatron oscillations”. One of the main reasons for this name is the importance of **transverse beam stability in betatrons**, where particles accelerate slowly for up to millions of turns.

One of the typical early errors in building betatrons, cyclotrons and microtrons was a desire to make the **vertical magnetic field near the orbit as homogeneous as possible**. Stability of transverse motion was not considered to be important and good engineers who build a nearly ideal magnets **saw that beam intensity dies off when beam propagates for more and more turns** – naturally in betatrons it was the most noticeable problem.

Post-factum it is easy to understand that a **charged particle in ideal parallel vertical magnetic field will have a helical trajectory** and particles even with a small vertical momentum will fly away, hit vacuum chamber and get lost.

In fact, in cyclotrons this effect was not very important and Livingston (at that time a student) shim the cyclotron magnet in small steps to make beam propagating without loss....

**To solve this problem** – you will derive exact equations later in the course – a simple solution was found to slightly bend the magnetic field lines and introducing a component of focusing (returning) force for a particle, which wonder off the plane of the magnet. Reducing magnetic field with the radius provides for the returning force in vertical direction.

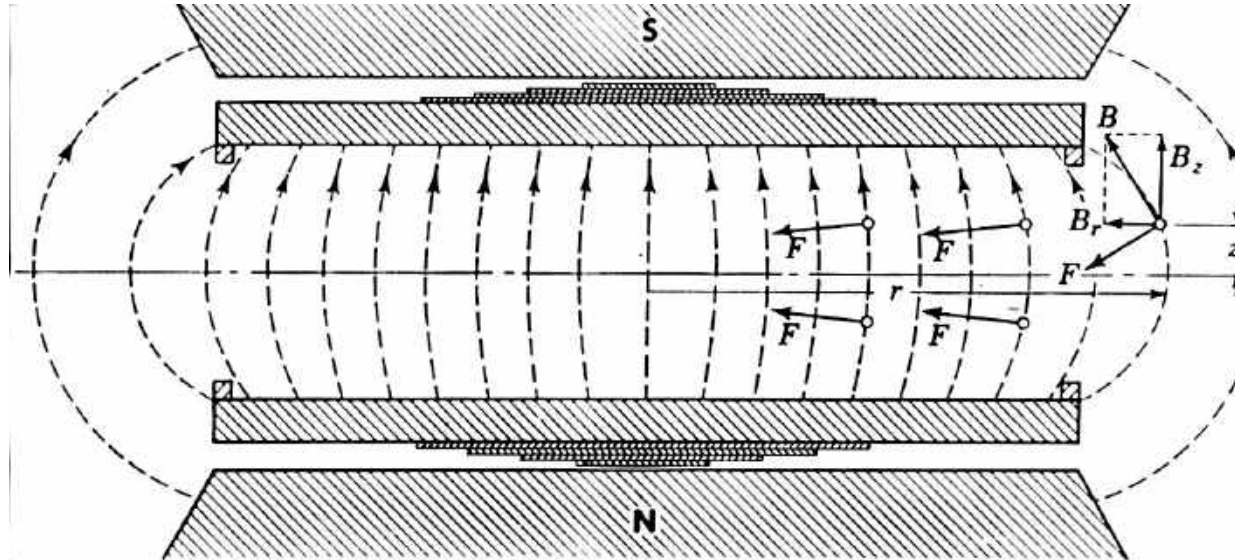

*Principle of vertical (weak focusing) using in cyclotrons*

Operating betatrons (see fig. 2.14) also used weak focusing forcing particles to execute stable vertical (and horizontal) oscillations about the ideal closed orbit. These oscillations were most prominent and were studied in details in betatrons – **hence, the name betatron oscillations stuck!**



**A betatron accelerator can be “un-wrapped” into a linear accelerator.** One of the version uses a set of toroidal ferromagnetic cores to generate a longitudinal field is shown here:

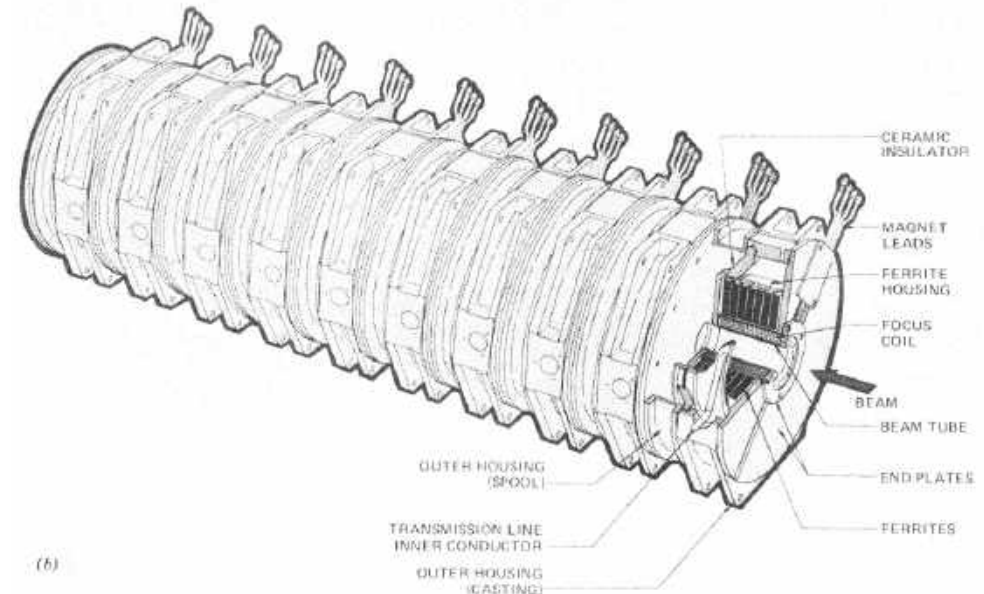
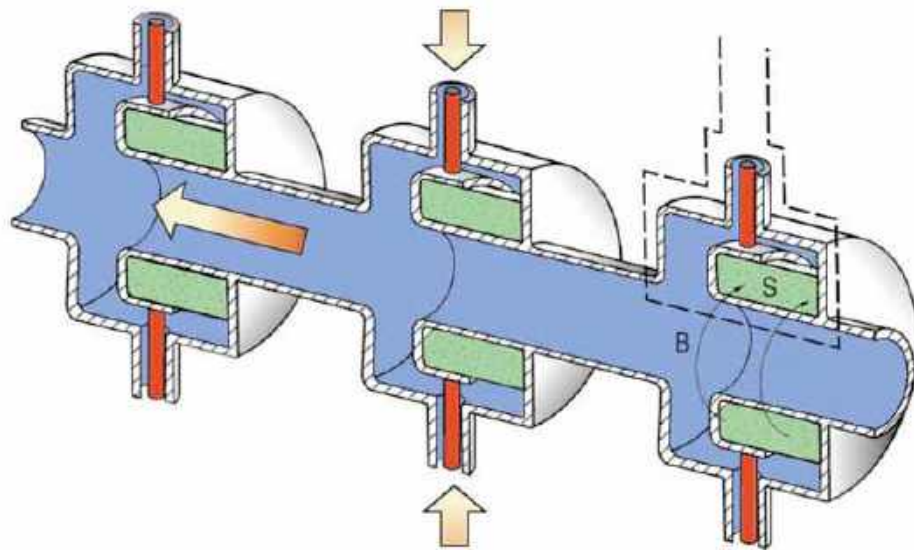

Figure 10-4 (Continued).

*Left: An operational principle of induction linac (-or a linear betatron) invented by Christofilos (also inventor of strong focusing) and (right) schematic of operational induction linac*

Betatron were (and are still) successful simple pulsed accelerators, which operate with very high peak currents beams (kA!). But while successful, betatrons are limited in accelerating gradients and voltages by the voltage induced in the excitation coils.

# Era of Synchrotrons

By 1940s all the above acceleration principles: DC, resonant and induction (betatron) had been successfully demonstrated. Having a solid-core magnets – with sizes reaching 10s of meters – becomes impossible fit and scientists started developing accelerators comprised of a separate lump magnets and RF structures.

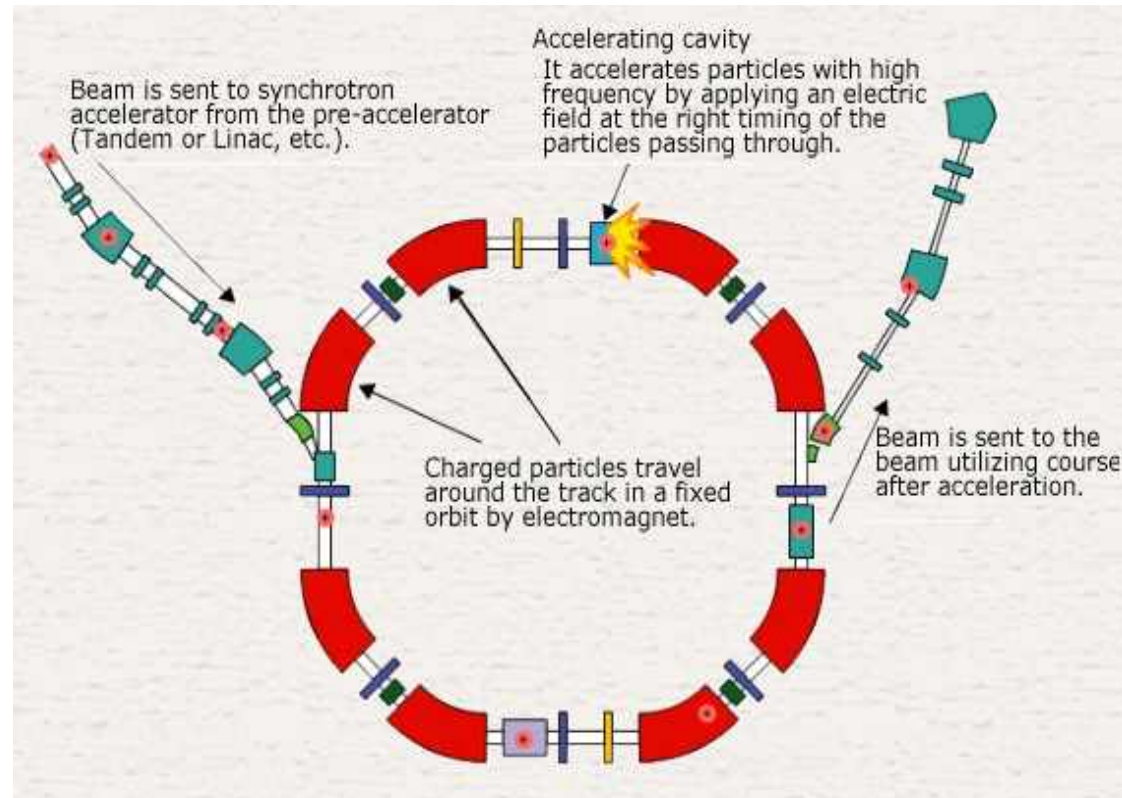

*A simple synchrotron with injection, 8 dipole magnets and an accelerating RF cavity*

**Synchrotrons - in contrast with storage rings - were designed to accelerate particles from injection energy to ejection energy** to send it either to the next accelerator (some complexes had chains of three-four synchrotrons with increasing energy reach) or to a target. RF cavity serves as turn after turn energy booster for the beam while the magnets have to follow (which is always slow process as you already know!) the increasing energy of the beam with the increase of their field – the process called ramping.

The operational principles of synchrotron, when you know them, are very straight forward:

- the particle motion (e.g. magnetic fields and time of flight) and the accelerating field in RF cavity have to be synchronized (hence the name synchrotron);
- the motion in all three directions must be stable.

The first problem was mostly engineering one sets the ramping cycle of the magnets (frequently using the line AC frequency: 50 Hz in Europe, 60 Hz in US) and follow it up with necessary change of the RF frequency to beam synchronized with the accelerating cycle in the cavity:

$$T_o = \frac{C}{v} = n \cdot T_{RF} = \frac{n}{f_{RF}} \quad (2.11)$$

Changing the RF frequency is mostly required in hadron synchrotrons, where particles do not reach relativistic velocities till very high energies. For example AGS (Alternating Gradient Synchrotron) accelerates protons from kinetic energy of 0.2 GeV to 28 GeV – this requires a nearly two-fold change of the RF frequency. You would learn later in the course that this is not a trivial but doable.

Slightly different story is for electrons – it is relatively easy to accelerate electrons to tens of MeV before injecting them into a synchrotron. Usually then the available aperture of the vacuum chamber is sufficient to accommodate a slight variation of the electron's velocity. This answers the first requirements – what about second?

## What about longitudinal motion ?

i.e. a particle slightly out of synchronism or slight off-energy? Would they survive or disappear? Veksler discovered the phase (auto-focusing) stability in circular accelerators by introducing the time of flight dependence of the particle's energy (frequently called a slip-factor):

$$\eta = \frac{d \ln T_o}{d \ln E} = \frac{d \ln C}{d \ln E} - \frac{d \ln v}{d \ln E} \quad (2.12)$$

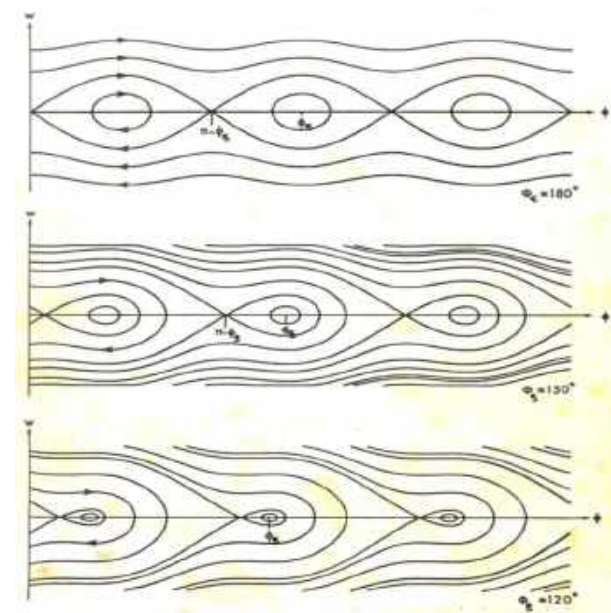
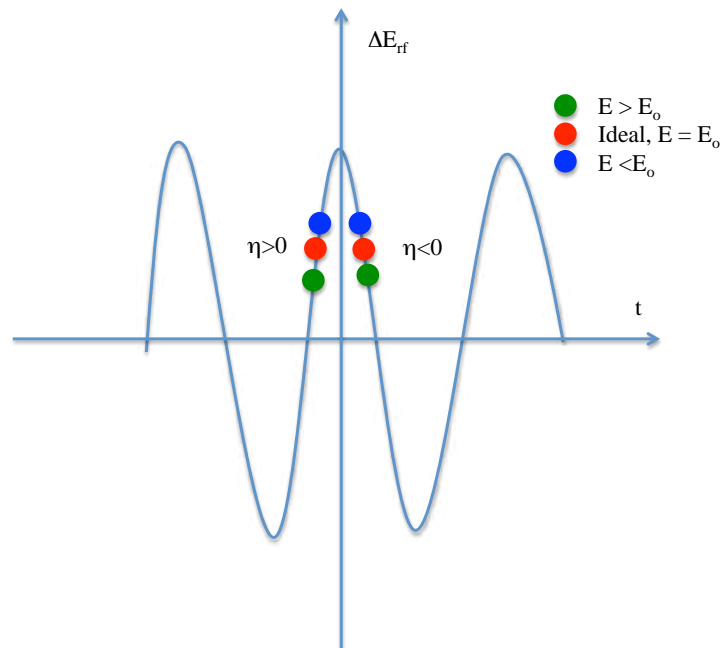

Veksler discovered that proper choice of accelerating phase provides for stability of longitudinal (phase – means RF phase) motion. It means that a particle with a phase or energy deviation will execute stable oscillations, which are called synchrotron oscillations. Details of the dynamics will be presented later in the course. By 1940's the principles of weak focusing for transverse motion and longitudinal stability were well known and this was working assumption that bending magnets have a gradient of the field splitting focusing between horizontal and vertical oscillations.

# Weak (transverse) focusing, plane orbit symmetry

To solve this problem let's expand the equations of motion near the ideal closed orbit:

$$\vec{r} = \hat{r} \cdot (\rho + x) + \hat{y} \cdot y; \rho = \frac{pc}{eB_o}; B_o = B_y(x=0, y=0) = \text{const};$$

$$\vec{B}(\vec{r}) \cong \hat{y} B_o + \hat{r} \left( \frac{\partial B_x}{\partial x} x + \frac{\partial B_x}{\partial y} y \right) + \hat{y} \left( \frac{\partial B_y}{\partial x} x + \frac{\partial B_y}{\partial y} y \right);$$

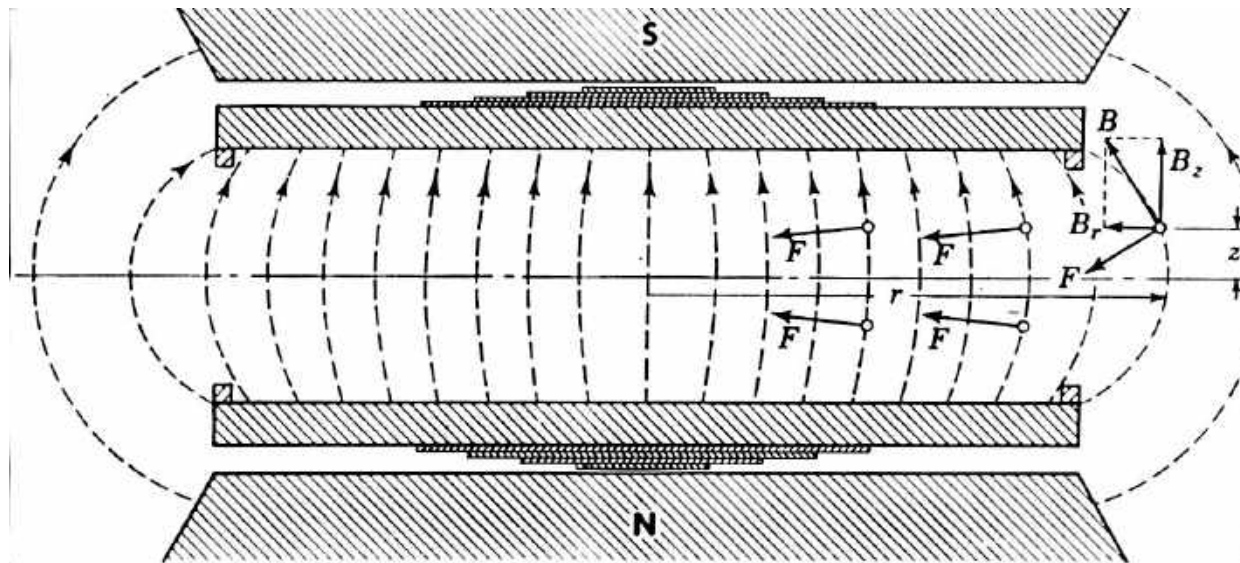

Because of the symmetry  $\frac{\partial B_y}{\partial y} = \frac{\partial B_x}{\partial x} = 0$ ; and  $\text{curl} \vec{B} = 0 \Rightarrow G = \frac{\partial B_y}{\partial x} = \frac{\partial B_x}{\partial y}$

$$\vec{B}(\vec{r}) \cong \hat{y} B_o + G(\hat{r}y + \hat{y}x) + O(x^2, y^2); |x|, |y| \ll \rho$$

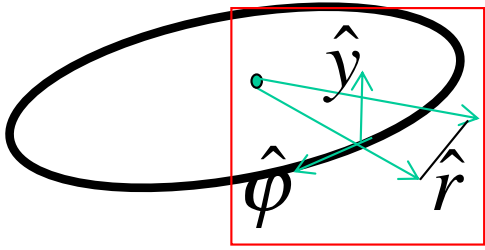

$$\vec{v} = \frac{d}{dt}(\hat{r} \cdot (\rho_o + x) + \hat{y} \cdot y) = \frac{d\hat{r}}{dt} \cdot (\rho_o + x) + \hat{r} \frac{dx}{dt} + \hat{y} \cdot \frac{dy}{dt};$$

$$\frac{d\hat{r}}{dt} = \omega \hat{\phi}; \quad \frac{d\hat{\phi}}{dt} = -\omega \hat{r}; \quad \frac{d^2\hat{r}}{dt^2} = -\omega^2 \hat{r}$$

$$\vec{v}_o = \hat{\phi} \cdot \omega \rho_o; \quad \vec{v} = \hat{\phi} \cdot \omega (\rho_o + x) + \hat{r} \dot{x} + \hat{y} \cdot \dot{y}$$

$$\frac{d\vec{v}}{dt} = \frac{d^2\hat{r}}{dt^2} \cdot (\rho_o + x) + \frac{d\hat{r}}{dt} \frac{dx}{dt} + \hat{r} \frac{d^2x}{dt^2} + \hat{y} \cdot \frac{d^2y}{dt^2}$$

$$\frac{d\vec{v}}{dt} = \hat{r} \left\{ \frac{d^2x}{dt^2} - \omega^2 \cdot (\rho_o + x) \right\} + \hat{y} \cdot \frac{d^2y}{dt^2} + \omega \hat{\phi} \dot{x}$$

$$\vec{B}(\vec{r}) \cong \hat{y} B_o + G(\hat{r}y + \hat{y}x)$$

Since energy is constant in magnetic field

$$\begin{aligned} \frac{d\vec{p}}{dt} &= \gamma m \frac{d\vec{v}}{dt} = \frac{e}{c} [\vec{v} \times \vec{B}] \cong \frac{e}{c} \left[ \left[ \hat{\phi} \cdot \omega (\rho_o + x) + \hat{r} \dot{x} + \hat{y} \cdot \dot{y} \right] \times \left[ \hat{y} B_o + G(\hat{r}y + \hat{y}x) \right] \right] \\ &= \frac{e}{c} \left[ -\hat{r} B_o \omega (\rho_o + x) + \omega \rho_o G (\hat{y} \cdot y - \hat{r}x) + \hat{\phi} B_o \dot{x} + O(\epsilon^2) \right] \end{aligned}$$

$$\frac{d\vec{v}}{dt} = \hat{r} \left\{ \frac{d^2x}{dt^2} - \omega^2 \cdot (\rho_o + x) \right\} + \hat{y} \cdot \frac{d^2y}{dt^2} + \omega \hat{\phi} \dot{x} = \frac{e}{\gamma mc} \left[ -\hat{r} B_o \omega (\rho_o + x) + \omega \rho_o G (\hat{y} \cdot y - \hat{r}x) + \hat{\phi} B_o \dot{x} \right]$$

$$\frac{d^2x}{dt^2} - \omega^2 \cdot (\rho_o + x) = -\omega \left[ \frac{e B_o}{\gamma mc} (\rho_o + x) + \frac{e G}{\gamma mc} \rho_o x \right] + O(\epsilon^2)$$

$$\frac{d^2y}{dt^2} = \omega \rho_o \frac{e G}{\gamma mc} y + O(\epsilon^2)$$

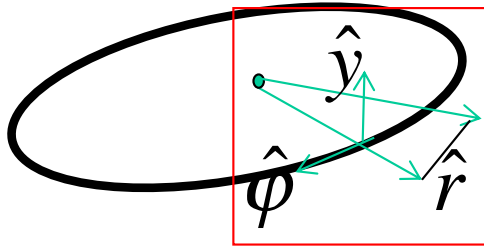

$$\frac{d^2x}{dt^2} - \omega^2 \cdot (\rho_o + x) = -\omega \left[ \frac{eB_o}{\gamma mc} (\rho_o + x) + \frac{eG}{\gamma mc} \rho_o x \right] + O(\epsilon^2)$$

$$\frac{d^2y}{dt^2} = \omega \rho_o \frac{eG}{\gamma mc} y + O(\epsilon^2)$$

$$\hat{\phi} \times \hat{r} = \hat{y}$$

$$\hat{r} \times \hat{y} = \hat{\phi}$$

$$\hat{\phi} \times \hat{r} = \hat{y}$$

$$dl = v_o dt = \omega dt (\rho_o + x) \Rightarrow \omega = \frac{v_o}{(\rho_o + x)} \cong \frac{v_o}{\rho_o} \left( 1 - \frac{x}{\rho_o} \right)$$

$$\omega_o = \frac{v_o}{\rho_o} = \frac{eB_o}{\gamma mc} \Rightarrow \rho_o = \frac{p_o c}{eB_o}$$

$$\frac{d^2x}{dt^2} + \omega_o^2 (1 - n) \cdot x \cong 0; \quad \frac{d^2y}{dt^2} + n\omega_o^2 = 0; \quad n = -\frac{G\rho_o}{B_o}.$$

*Stability:*  $0 < n < 1$ ;

$$x = a_x \cos(v_x \omega_o t + \varphi_x); \quad y = a_y \cos(v_y \omega_o t + \varphi_y); \quad v_x = \sqrt{1 - n}; \quad v_y = \sqrt{n};$$

$$\dot{x} = v_x \omega_o a_x \sin(v_x \omega_o t + \varphi_x); \quad \dot{y} = -v_y \omega_o a_y \sin(v_y \omega_o t + \varphi_y);$$

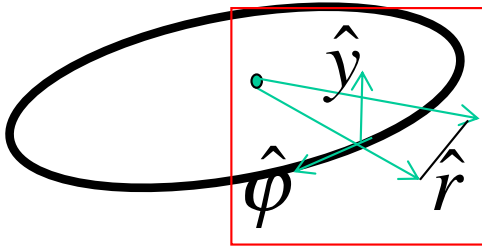

Stability:  $0 < n < 1$ ;

$$x = a_x \cos(\nu_x \omega_o t + \varphi_x); \quad y = a_y \cos(\nu_y \omega_o t + \varphi_y); \quad \nu_x = \sqrt{1-n}; \nu_y = \sqrt{n};$$

$$\dot{x} = \nu_x \omega_o a_x \sin(\nu_x \omega_o t + \varphi_x); \quad \dot{y} = -\nu_y \omega_o a_y \sin(\nu_y \omega_o t + \varphi_y);$$

Invariants:  $\varepsilon_x = \frac{1}{\gamma m c} \oint dx dp_x; \varepsilon_x = \frac{1}{\gamma m c} \oint dy dp_y$ ; length along trajectory  $s = \omega_o t$ ;

$$x = \sqrt{\beta_x \varepsilon_x} \cos\left(\frac{s}{\beta_x} + \varphi_x\right); \quad y = \sqrt{\beta_y \varepsilon_y} \cos\left(\frac{s}{\beta_y} + \varphi_y\right);$$

$$\frac{dx}{ds} = x' = -\sqrt{\frac{\varepsilon_x}{\beta_x}} \sin\left(\frac{s}{\beta_x} + \varphi_x\right); \quad \frac{dy}{ds} = y' = -\sqrt{\frac{\varepsilon_y}{\beta_y}} \sin\left(\frac{s}{\beta_y} + \varphi_y\right);$$

$$\beta_x = \frac{\rho_o}{\sqrt{1-n}} > \rho_o; \beta_y = \frac{\rho_o}{\sqrt{n}} > \rho_o;$$



In 1944 Veksler and McMillan (independently) proposed synchrotron as a next step towards high energy accelerators. **First synchrotrons were built using weak focusing.** Naturally they were using room temperature magnets and their radius was growing. One important feature of weak focusing is that particles execute less than one oscillation per turn. It means that for a fixed transverse angle particle deviation from ideal orbit will be proportional to the machine radius – hence the aperture of the accelerators went up with their energy. Technicians climbed inside vacuum chambers, physicist had meetings inside magnet aperture... in short, a new type of monsters appeared.

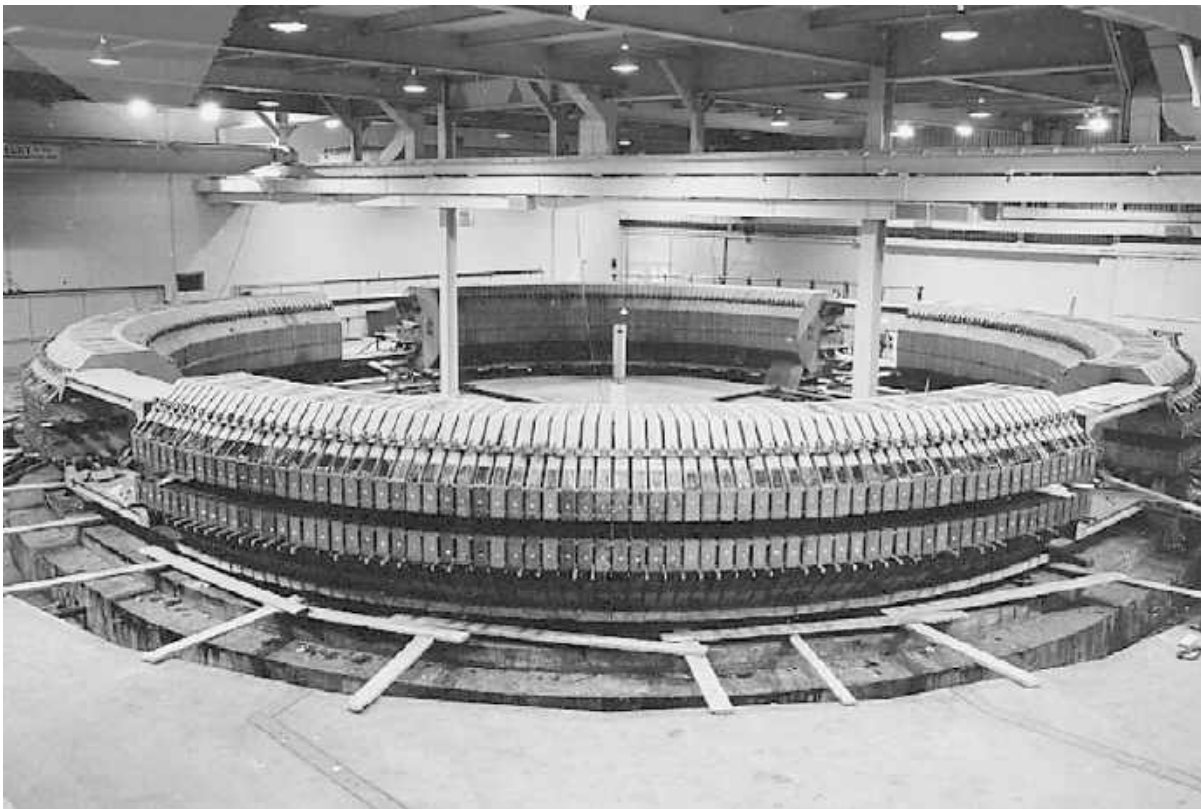

*Left – BNL's Cosmotron and magnet aperture of 6 GeV weak-focusing Bevatron*

# Strong focusing

Physicist new about quadrupoles – magnets, which because of the Maxwell equations focused in one direction and defocus in the other:

$$\text{curl}\vec{B} = \hat{z} \left( \frac{\partial B_x}{\partial y} - \frac{\partial B_y}{\partial x} \right) = 0; B_x = G \cdot y; B_y = G \cdot x; \vec{B} = G(\hat{x} \cdot y + \hat{y} \cdot x)$$

$$\hat{x} \times \hat{y} = \hat{z} \rightarrow \hat{z} \times \hat{y} = -\hat{x}; \vec{F} = -\frac{e}{c} [\vec{v} \times \vec{B}] \Rightarrow \vec{v} = \hat{z}v \Rightarrow \quad (2.13)$$

$$\vec{F} = -\frac{eG}{c} (x(\hat{z} \times \hat{y}) + y(\hat{z} \times \hat{x})) = \frac{eG}{c} (\hat{x} \cdot x - \hat{y} \cdot y)$$

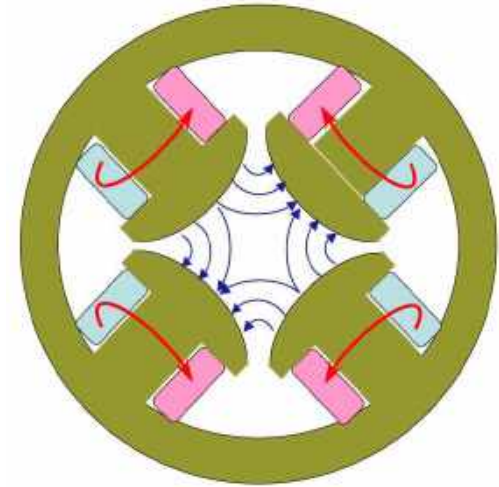

It was (again) Christofilos who found a way out of this puzzle in 1949 by inventing a strong focusing. The idea is rather straight forward, again, after you know about it: a combination of focusing and defocusing lens results is focusing

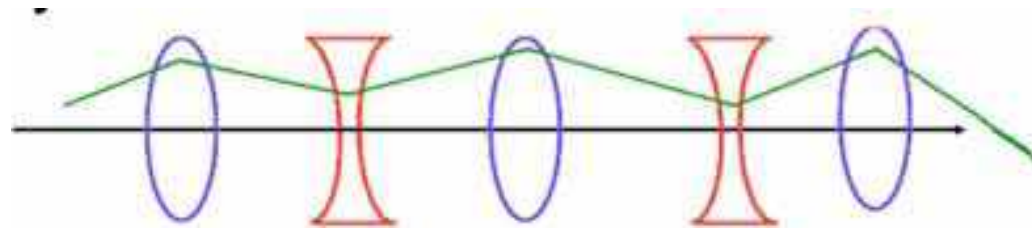

One can calculate a focusing lens and a defocusing lens with focal length of  $F$  separate distance  $L$  to find that the remaining focusing force in both directions to be (consider it as an exercise).

$$F_{eff} = \frac{F^2}{L} \quad (2.14)$$

This seemingly simple step, later combined with an exquisite theory developed at BNL by Courant and Snyder (the theory you would learn in this course), made a real revolution. Modern accelerators based on the strong focusing have apertures from few cm to few millimeters (where and when needed).



## This course is part of the Ernest Courant Traineeship in Accelerator Science and Engineering



- Ernest Courant is one the most famous accelerator physicists. He wrote “must-to-know” classical paper "*Theory of the alternating-gradient synchrotron*" in *Annals of Physics*, 1958, 3 (1) 1. This paper was the dawn of new era in modern accelerator physics
- Ernest Courant (1920 – 2020) was working at BNL since 1948 and also was Adjunct Professor from 1966 till 1986 in our department. Dr. Courant’s family graciously gave us permission using Dr. Ernest Courant name for this traineeship.
- The traineeship is the consortium of SBU, BNL and FNAL with Center for Accelerator Science and Education (CASE) being the lead organization

# Era of storage rings and colliders.

The era of storage rings and colliders arrived on the shoulders of existing physics and technology already developed for synchrotrons. The new additions were superconducting magnets and superconducting RF systems. The main factor was also developing of ultra-high vacuum technology so beams can leave for hours and days in a properly designed storage rings.

It was natural to think about colliding beam in either the same storage ring where particles and antiparticles (electrons and positrons or protons and antiprotons) circulate in opposite directions and collide in a detector(s). A TEVATRON in FERMI-lab was based on this principle and well as LEP – both are closed now. Using two intersecting storage rings would allow colliding particles of any type with each other: this method is used in RHIC, LHC, B-factory.

As we discussed, the energy available for creating new particles in a collision is determined the the c.m. energy, which can be expressed as a scalar product of the total 4-momentum:

$$M = \frac{\sqrt{P_i P^i}}{c} = \frac{1}{c} \sqrt{\frac{E^2}{c^2} - \vec{p}^2}; P^i = p_1^i + p_2^i \quad (2.15)$$

As we discussed in our first class that colliding a relativistic particles  $p_1^i = \gamma(m_1 c, m_1 \vec{v})$  with a stationary particle  $p_2^i = (m_2 c, 0)$  (a target) provides for a square root dependence of the available energy on the energy of the accelerator:

$$M = \sqrt{m_1^2 + m_2^2 + 4\gamma\beta m_1 m_2}; \quad (2.16)$$

At the same time, two particles (with the same mass) colliding head-on  $p_{1,2}^i = \gamma(mc, \pm m\vec{v})$  can generate mass up to the total energy of two particles:

$$M = 2\gamma m \quad (2.17)$$

Thus, in late 1950 the ideas of colliding relativistic particles circulating in a storage ring was born. The skeptics who were using synchrotrons predicted this to be complete failure. The reasoning beyond this skepticism was so called luminosity of the collider....

# Luminosity and Colliders

Processes in high energy and nuclear physics are described by a cross-section,  $\sigma$ . Then the number of the processes generated during collision of a particle with a target of transverse density  $\frac{N_t}{A}$ , where  $N_t$  is the number of particles of interest in the target and  $A$  is its transverse area. If one will send  $\dot{N}_b$  particles per second onto the target from an accelerator, the rate of the generated processes (events) will be given by:

$$R = \frac{dN_{events}}{dt} = \sigma \cdot \dot{N}_b \cdot \frac{N_t}{A} = \sigma \cdot L \rightarrow L = \dot{N}_b \cdot \frac{N_t}{A} \quad (2.19)$$

where we introduced luminosity of the experiment,  $L$ . With  $\frac{N_t}{A} \sim 10^{23} \text{ cm}^{-2}$  of the solid target it is very hard to compete having from  $10^9$  to  $10^{11}$  particles per bunch. Let's consider two colliding beams consisting for individual bunches. Let's bunches collide with the collision rate  $f_c$ . Then during the collision the first beam sees particles in the second beam. The first beam intensity is nothing that the collision (bunch) rate multiplied by the number of particles in the bunch 1.

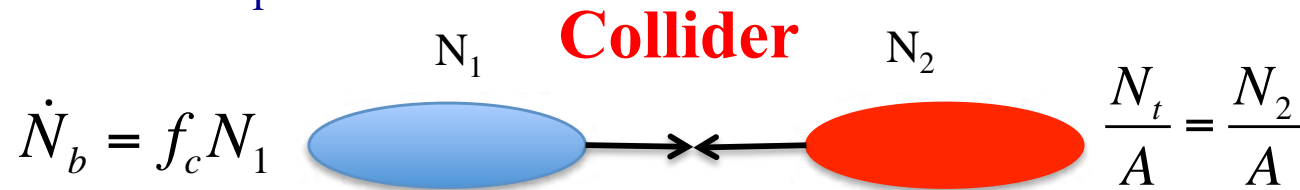

Plugging this in (2.19) we can write luminosity for colliding beams:

$$L = f_c \cdot \frac{N_1 N_2}{A} \quad (2.20)$$

Naturally, the success of the modern colliders was built upon colliding beams with very small transverse sizes, e.g. with a very high density and on high collision frequency. After this course you would know how the beam quality (emittance,  $\varepsilon$ ) and the beam optics (beta-functions,  $\beta$ ) affect the luminosity via  $A = 4\pi\beta\varepsilon$ .

# Light sources

You are well aware that electrons when accelerated (rotated in the bending magnets or “shacked” in wigglers and undulators. They radiate incoherent radiation with critical wavelength  $\lambda \sim \rho/\gamma^3$  and  $\lambda \sim \lambda_u/\gamma^2$  from undulators. Most of popular storage ring light sources operate in X-ray or soft-X-ray range of photon energies, which result in energies from 3 to 8 GeV.

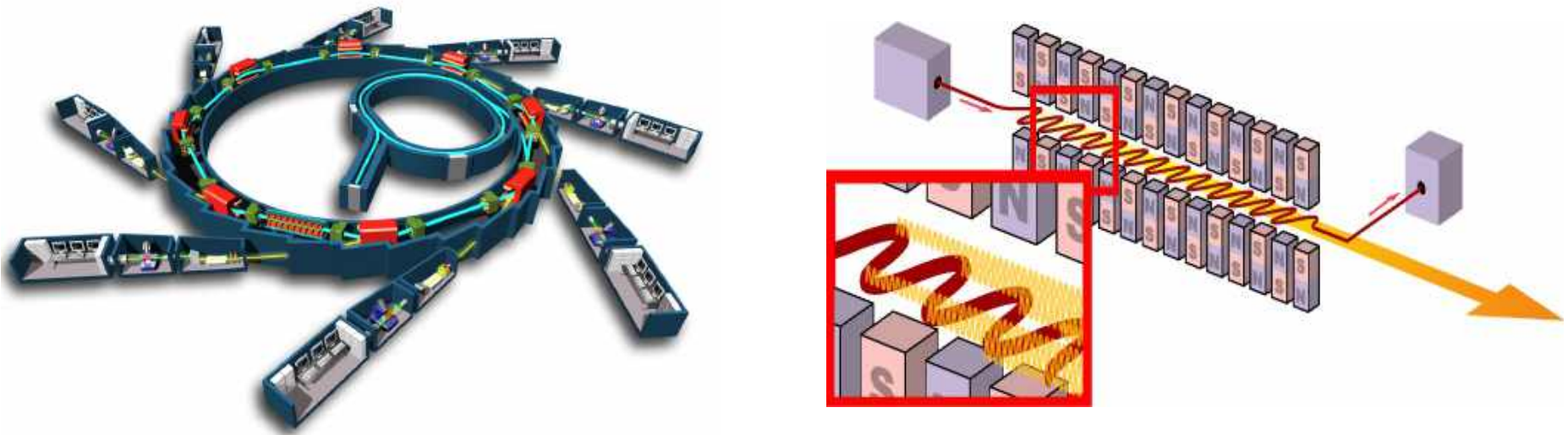

*Typical layout of ring-based light source and an FEL*

Again, we will discuss details later in this course

# Light sources: figure of merit

The quality of the generated photon beams is characterized by peak (or average) spectral brightness measured in number of photons per second radiated into a desirable energy spread from a unit areas into a unit solid angle.

$$B = \frac{\dot{N}_{ph}}{A \cdot \Omega} \cdot \frac{\delta E}{\sigma_E} \quad (2.21)$$

FELs are generating photon beams using instability of the system comprised of electron beam propagating in an undulator and TEM optical wave. Resulting X-ray beams have laser quality and X-ray FELs (currently operating only in pulsed mode) have peak spectral brightness exceeding that of other light sources by about 10 orders of magnitude.

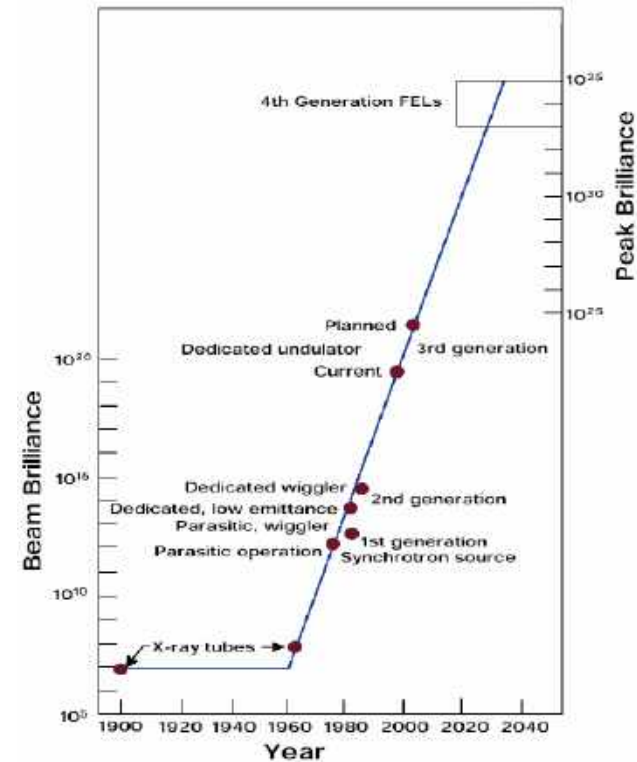
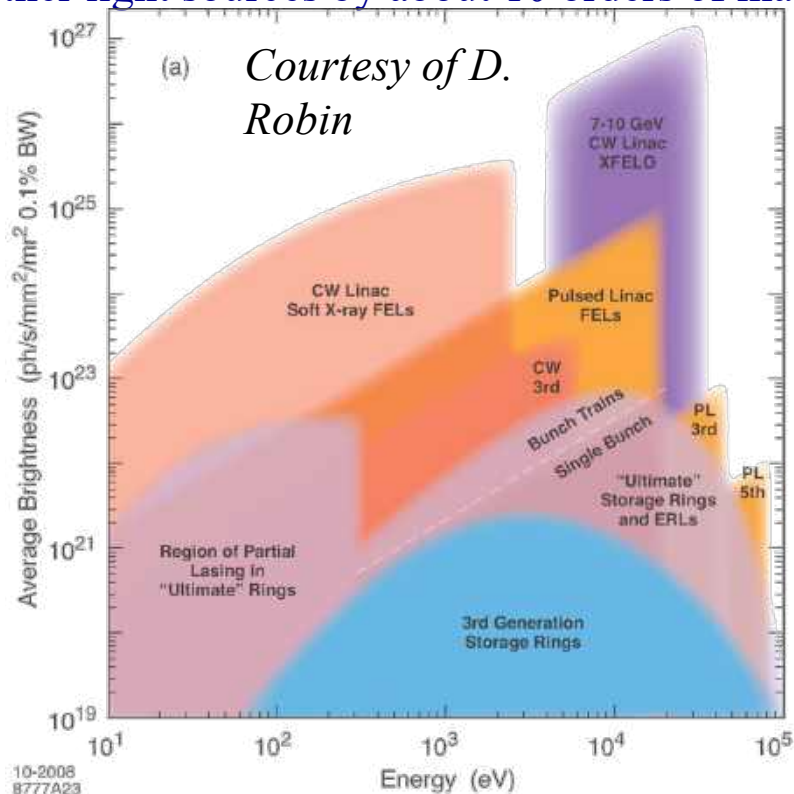

*Average spectral brightness of light sources (left) and equivalent of the Livingston plot for light sources*

# References

- [1] A BRIEF HISTORY AND REVIEW OF ACCELERATORS, P.J. Bryant, CERN, Geneva, Switzerland, <http://cds.cern.ch/record/261062/files/p1.pdf>
- [2] J.D. Cockcroft and E.T.S. Walton, "Experiments with high velocity ions", Proc. Royal Soc., Series A 136 (1932), 619–30.
- [3] R.J. Van de Graaff, "A 1,500,000 volt electrostatic generator", Phys. Rev., 387, (Nov.1931), 1919
- [4] [http://cdn.preterhuman.net/texts/science\\_and\\_technology/physics/](http://cdn.preterhuman.net/texts/science_and_technology/physics/) , Principles of Charged Particle Accelerators/chap10.pdf
- [5] [www.werc.or.jp/english/reseadeve/activities/accelerator/accelerator/synchro/index.htm](http://www.werc.or.jp/english/reseadeve/activities/accelerator/accelerator/synchro/index.htm)
- [6] E.M. McMillan, "The synchrotron - a proposed high-energy particle accelerator", Phys. Rev., Letter to the editor, 68 (Sept. 1945), 1434.
- [7] V. Veksler, J. of Phys, USSR, 9 (1945), 153–8.
- [8] E.D. Courant and H.S. Snyder, *Annals of Physics*, 3, 1, 1958
- [9] D.W. Kerst, "The acceleration of electrons by magnetic induction", Phys. Rev., 60 (July 1942), 47
- [10] M.S. Livingston, "Particle accelerators: A brief history", Harvard University Press, Cambridge, Massachusetts (1969), 32.
- [13] E.D. Courant, M.S. Livingston and H.S. Snyder, "The strong-focusing synchrotron – a new high-energy accelerator", Phys. Rev., 88 (Dec. 1952), 1190-6, and
- [14] N.C. Christofilos, Unpublished report (1950), and U.S. Patent no. 2.736,799, filed March 10, 1950, issued February 28, 1956. Energy Accel., CERN, 1971 (CERN, Geneva, 1971), 501–4.